

LUXURY GOLD BASINS

GD[®]
GLASS DESIGN
ITALY

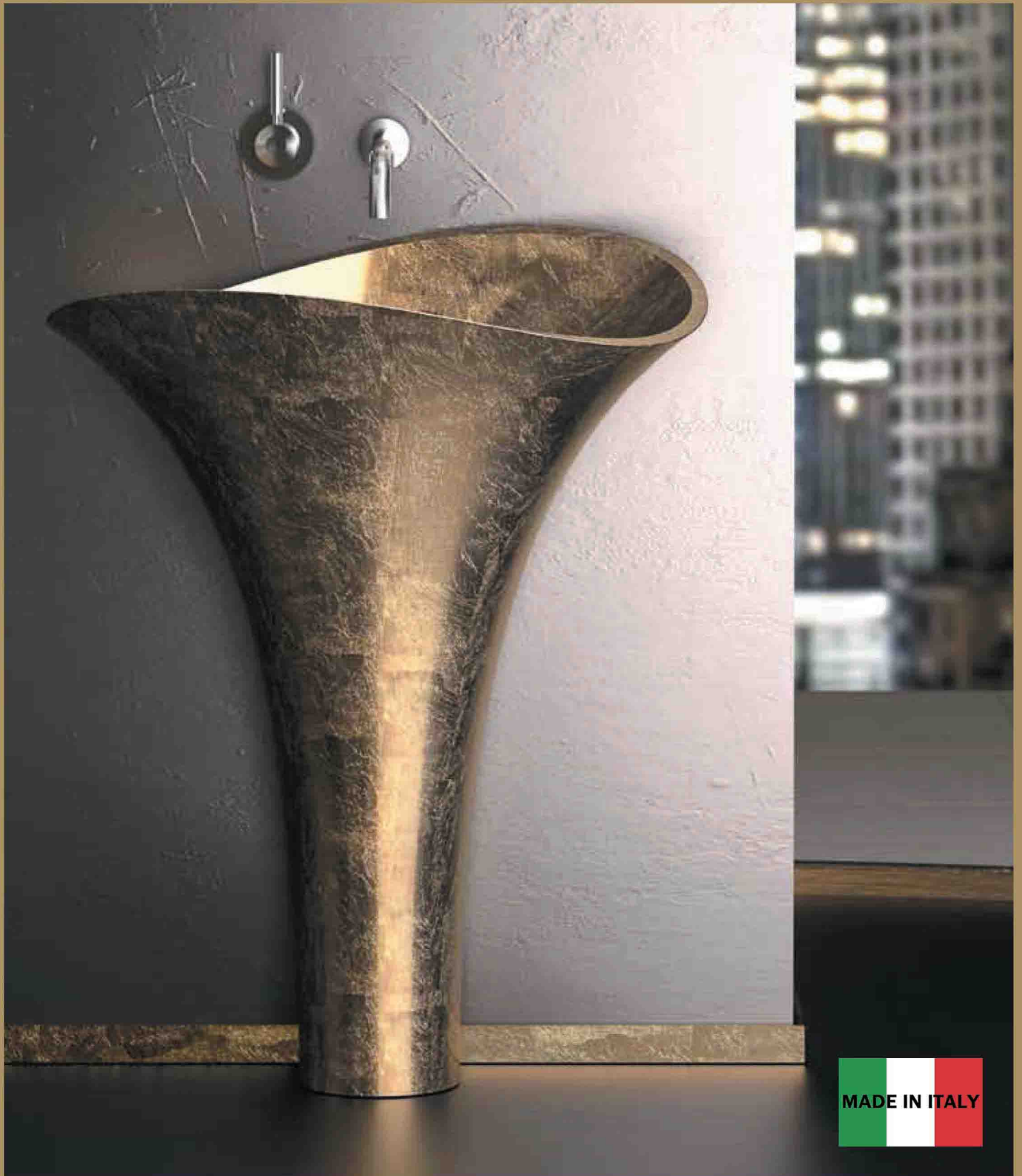

SIT ON BASINS

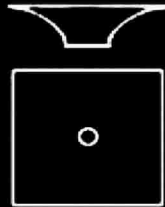

500 x 500 x
140h mm

Roma Series ROMAFO

Sit on basin

Finish: Gold Leaf 3D TeknoForm®

Material: TeknoForm®

TeknoForm is a polymer-based material. It expresses itself by enhancing the surface of its products. From mosaics to stone, from marble to wood, an incredible variety of solutions can be realised in creating unique products.

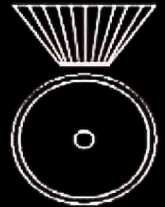

400Dia x
155h mm

Tekno40 Series TEKNO40LGD

Sit on basin

Finish: Gold 24 kt

Material: Florence Glass
ATELIER®

The "Florence Glass Atelier" project is inspired by embedding the philosophy of the fashion world into product research. The focus lays on enhancing crystal material with colours and textures of fashion trends.

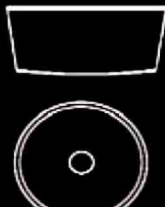

399Dia x
180h mm

Forma Lux Series FORMALXGD

Sit on basin

Finish: Gold 24 kt Florence Glass Atelier

Material: Florence Glass
ATELIER®

The "Florence Glass Atelier" project is inspired by embedding the philosophy of the fashion world into product research. The focus lays on enhancing crystal material with colours and textures of fashion trends.

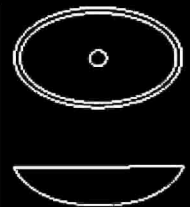

510 x 345 x
155h mm

Ice Oval Series ICEOVGDF3

Sit on basin

Finish: Gold 24 kt Florence Glass Atelier

Material: Florence Glass
ATELIER®

The "Florence Glass Atelier" project is inspired by embedding the philosophy of the fashion world into product research. The focus lays on enhancing crystal material with colours and textures of fashion trends.

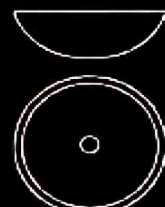

420Dia x
145h mm

Mosaic Series MOSAICFO

Sit on basin

Finish: Gold Leaf 3D TeknoForm®

Material: TeknoForm®

TeknoForm is a polymer-based material. It expresses itself by enhancing the surface of its products. From mosaics to stone, from marble to wood, an incredible variety of solutions can be realised in creating unique products.

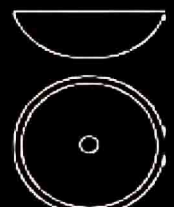

500Dia x
140h mm

Circus 50 Series CIRCUS50FO

Sit on basin

Finish: Gold Leaf 3D TeknoForm®

Material: TeknoForm®

TeknoForm is a polymer-based material. It expresses itself by enhancing the surface of its products. From mosaics to stone, from marble to wood, an incredible variety of solutions can be realised in creating unique products.

UNDER-COUNTER BASINS



Flou Series FLOUSFO + SCGDP + TP

Under counter basin

Finish: Pert 3D Gold Leaf

Material: **Pert**[®]

polimero tecnologico

Pert[®] is a technological polymer of extraordinary quality, combining a low specific weight with high mechanical resistance. It is particularly suited to fields where light weight is essential (e.g. in nautical, aeronautical, camping, ...). It is a material which enables the creation of products of high design, finely made, allowing perfectly crafted angles and a smoothly plane surface, with the possibility of choosing among a wide range of colours to suit individual demand.

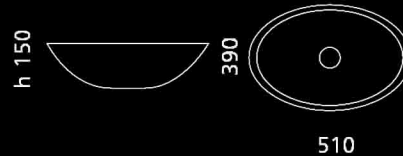

Blade Series BLASFO + TPG

Under counter basin

Finish: Pert 3D Gold Leaf

Material: **Pert**[®]

polimero tecnologico

Pert[®] is a technological polymer of extraordinary quality, combining a low specific weight with high mechanical resistance. It is particularly suited to fields where light weight is essential (e.g. in nautical, aeronautical, camping, ...). It is a material which enables the creation of products of high design, finely made, allowing perfectly crafted angles and a smoothly plane surface, with the possibility of choosing among a wide range of colours to suit individual demand.

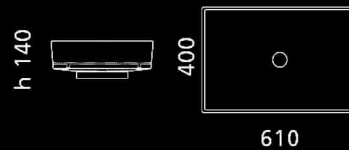

FREE-STANDING BASIN

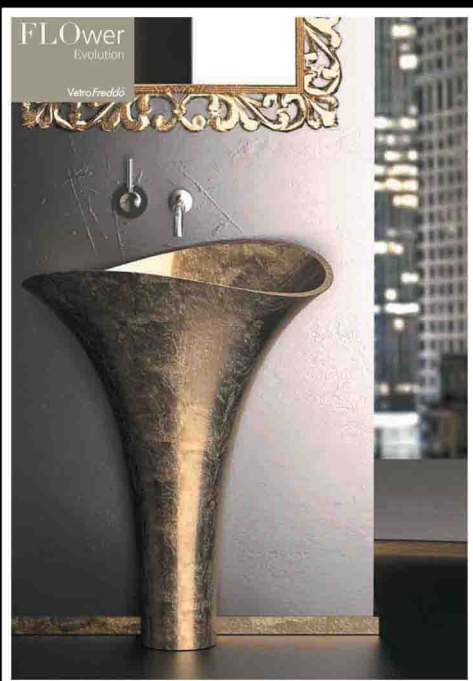

Flower Evolution Series FLOEVOFO

Free-standing basin

Finish: VetroFreddo Gold Leaf 3D

Material: **VetroFreddo**[®]

VetroFreddo[®] is an innovative material composed of glass pigments and resin. Its major characteristics are its versatility in adapting itself to any form or shape imaginable. The material's unique characteristics are expressed through the soul of its colour, which can be in transparent, semi-transparent or opaque form, due to the material composition of glass pigments. No limits exist in regards to colour. Apart from the existing range of colours, any colour from the "RAL" colour scheme can be chosen. VetroFreddo[®] is temperature resistant up to approximately 100°C

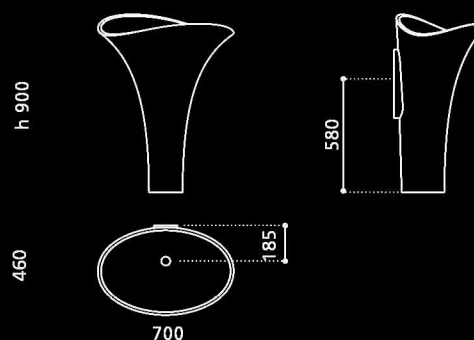



**Equip-Bathrooms Singapore
- Head Office & Flagship Showroom**

(by Equip-Bathrooms Pte Ltd)
33 Ubi Avenue 3, #04-35, Vertex Tower B,
Singapore 408868
Telp: (65) 6338 3838 / 6339 5588
Email: ilovemybathroom@equip-design.com
Website: www.equip-bathrooms.com

Sandimas Jakarta

Muara Karang Blok L-IX Selatan No. 1-7,
Jakarta Utara 14450 - Indonesia
Telp: (021) 6669 1080 | Fax: (021) 6669 1070
Mobile: 081 6111 4488
Email: linda@sandimasgroup.com
Website: www.sandimas.co.id

Sandimas Bali

Jl. Gatot Subroto Barat No. 688, Denpasar Utara,
Kota Denpasar, Bali 80111 - Indonesia
Telp: (0361) 849 5088
Mobile: 081 6111 4488
Email: linda@sandimasgroup.com
Website: www.sandimas.co.id