



IB RUBINETTI



General catalogue / Catalogo generale / Catalogue général



IBRUBINETTI

WE ARE ITALIAN DESIGN CULTURE

ST STORY | STORIA | HISTOIRE

TR TECHNICAL REFERENCE | REFERENZE TECNICHE
RÉFÉRENCE TECHNIQUE

BH BATHROOM COLLECTION | COLLEZIONE BAGNO |
COLLEZIONE BAGNO

SW SHOWER COLLECTION | COLLEZIONE DOCCIA |
COLLEZIONE DOCCIA

KC KITCHEN COLLECTION | COLLEZIONE CUCINA |
COLLEZIONE CUCINA



ST

STORY
STORIA
HISTOIRE





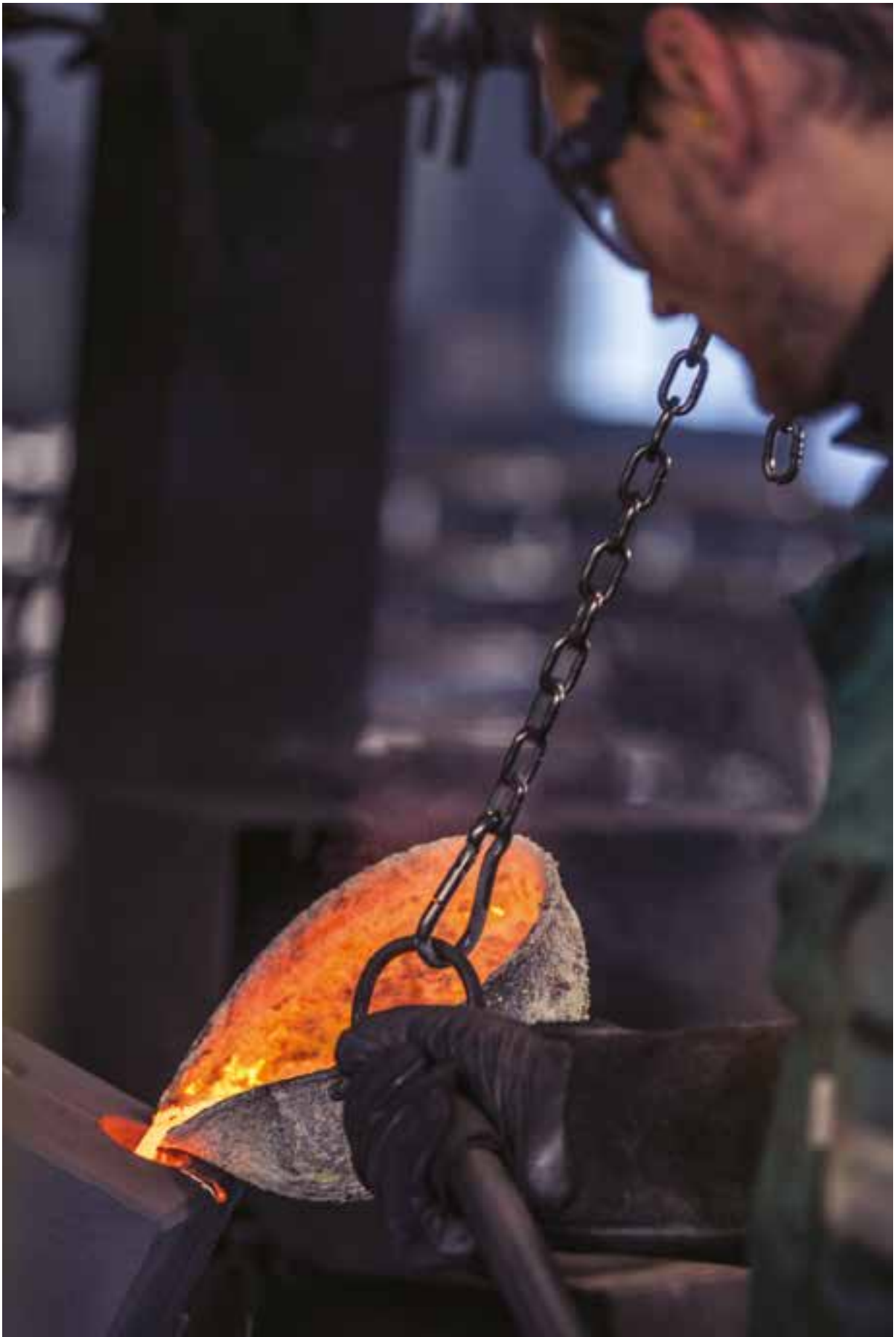







Water as a source of origin

The history of IB Rubinetti is rooted in a land of lakes and rivers, where the abundance of water has always been a crucial element for the socio-economical identity of the region. Brescia territory has always taken advantage of the wild waters of its rivers and of the placid surfaces of its lakes for its industrial and agricultural development.

Val Trompia has been one of the most active industrial centres in Italy since the beginning of the nineteenth century.

The town of Sarezzo, heart of the Val Trompia economic activity, is crossed by a source of life and abundance, River Mella, which flows from the peaks of Mount Maniva to the Po valley. Not far away, the River Oglio generates Lake Iseo flowing from Val Camonica, while Lake Garda originates from the dolomitic waters.

The influence that the territory has on IB Rubinetti's work is constant, and can also be found in the raw material selected, the brass. Residence to one of the most important national iron and steel industries,

L'acqua come origine

La storia di IB Rubinetti è radicata in una terra di laghi e di fiumi, in cui l'abbondanza dell'acqua è da sempre un fattore determinante per l'identità sociale ed economica della regione. Il territorio bresciano ha da sempre sfruttato le torrentizie acque dei suoi fiumi e le placide superfici dei suoi laghi per il proprio sviluppo industriale e agricolo.

La val Trompia era già all'inizio dell'Ottocento uno dei centri industriali più attivi d'Italia.

Il paese di Sarezzo, fulcro dell'attività economica della val Trompia, è attraversato da una fonte di vita e di abbondanza, il fiume Mella, che scorre dalle cime del monte Maniva fino alla pianura padana. Poco lontano, il fiume Oglio dalla Val Camonica genera il lago d'Iseo, mentre dalle acque dolomitiche ha origine il lago di Garda. L'influenza che il territorio ha sul lavoro di IB Rubinetti è costante, e la si ritrova anche nella materia prima lavorata, l'ottone. Sede di una delle più importanti industrie siderurgiche nazionali, che comprende





L'eau comme origine

L'histoire de IB Rubinetti est ancrée dans un territoire de lacs et de rivières, où l'abondance d'eau a toujours été un facteur déterminant pour l'identité sociale et économique de la région. La région de Brescia a depuis toujours exploité les eaux torrentielles de ses rivières et les placides surfaces de ses lacs pour son développement industriel et agricole.

La Val Trompia était l'un des centres industriels les plus actifs d'Italie déjà au début du XIXe siècle.

Le village de Sarezzo, cœur de l'activité économique de la Val Trompia, est traversé par une source de vie et d'abondance, la rivière Mella, qui coule du sommet du mont Maniva jusqu'à la vallée du Po. Un peu plus loin, la rivière Oglio, provenant de la Val Camonica, forme le lac d'Iseo, tandis que les eaux dolomitiques donnent origine au lac de Garde.

L'influence du territoire sur le travail d'IB Rubinetti est constante et se retrouve également dans la matière première traitée, le laiton. Siège de l'une des plus



ENG

which includes the entire iron processing cycle, Val Trompia has been one of the most active industrial centres in Italy since the beginning of the nineteenth century: the forges, with their fascinating hydraulic technology, exploited the bursting force of water flowing downstream to work this material, available in rich quantities in the whole territory. IB Rubinetti has managed to keep this ancient industrial tradition alive by working high quality brass. However, the tradition is not only the geographical one, but also the familiar one, transmitted from generation to generation.

IB Rubinetti was born in 1985 from Elio Bregoli's passion and high competence.

IB Rubinetti was born in 1985 from the passion and high competence of Elio Bregoli, president of the company. Built together with his wife Antonella, IB Rubinetti is enriched by their children's new ideas, enthusiasm and love for the profession. Andrea and Davide have recognized the value of tradition and have opened the business to international markets. However, the family is not only the one determined by blood ties, it is also the one we choose, the ones we love and the collaborative relationships that we build throughout a lifetime.

Being part of the IB world means being part of a family.



ITA

FRA



l'intero ciclo della lavorazione del ferro, la val Trompia era già all'inizio dell'Ottocento uno dei centri industriali più attivi d'Italia: i magli, con la loro affascinante tecnologia idraulica, sfruttavano la forza prorompente dell'acqua che scende verso valle per lavorare la materia prima di cui il territorio si mostrava ricco.

IB Rubinetti è riuscita a mantenere viva questa antica tradizione industriale, lavorando un ottone di alta qualità.

La tradizione non è tuttavia solo quella geografica, ma anche quella familiare, trasmessa di generazione in generazione.

IB Rubinetti nasce nel 1985 dalla passione e l'alta competenza di Elio Bregoli.

IB Rubinetti nasce nel 1985 dalla passione e l'alta competenza di Elio Bregoli, presidente dell'azienda. Fondata insieme alla moglie Antonella, IB Rubinetti si arricchisce grazie alle nuove idee, l'entusiasmo e l'amore per la professione, dei figli Andrea e Davide, che riconoscono il valore della tradizione e aprono l'azienda all'internazionalità.

La famiglia non è peraltro solo quella determinata dai legami di sangue, è anche quella che noi ci scegliamo, gli affetti e le relazioni collaborative che intessiamo nel corso di tutta una vita.

Essere parte del mondo IB significa far parte di una famiglia.



importantes industries sidérurgiques nationales, qui couvre le cycle entier du travail du fer, la Val Trompia était, déjà au début du XIXe siècle, l'un des centres industriels les plus actifs d'Italie: les marteaux hydrauliques, avec leur technologie fascinante, exploitaient la force irrépessible de l'eau qui descend vers la vallée pour travailler la matière première dont le territoire est riche. IB Rubinetti a réussi à maintenir cette ancienne tradition industrielle en travaillant un laiton de haute qualité. Cependant, la tradition n'est pas seulement celle géographique, mais aussi celle familiale, transmise de génération en

IB Rubinetti a été fondée en 1985 grâce à la passion et l'haute compétence d'Elio Bregoli.

génération. IB Rubinetti a été fondée en 1985 grâce à la passion et à l'haute compétence d'Elio Bregoli, président de la société. Fondée avec son épouse Antonella, IB Rubinetti s'enrichit grâce aux nouvelles idées, à l'enthousiasme et à l'amour du métier des fils Andrea et Davide, qui reconnaissent la valeur de la tradition et ouvrent l'entreprise à l'internationalité. Toutefois, la famille n'est pas seulement déterminée par les liens de sang, elle est aussi celle choisie, les affections et les collaborations que nous tissons tout au long de notre vie.

Faire partie du monde IB, c'est faire partie d'une famille.

ENG

This is why the IB family grows to include all workers and collaborators who, over the years, have engaged, together with the Bregoli family, this journey in an industrial production based on local traditions.

IB Rubinetti products are the outcome of the most advanced technological innovations, with a particular care for details and a technical and aesthetic quality.

IB Rubinetti's products do not emerge just from tradition, but also from the encounter with the most advanced technological innovations and from an attention to details and to technical and aesthetic qualities without equal.

The most innovative element is, without any doubt, the raw material processing method. The processed brass alloy is free of lead and zinc, and therefore hypoallergenic and purified by the main pollutants. Another revolutionary element is the desire to internalize the whole production chain: IB Rubinetti is involved in the manufacturing and the production of every single component, from the raw material to the most particular finishes.

An innovation that doesn't stop at the content, but also concerns the form. First in history, IB Rubinetti has become, since the beginning of the 2000s, a constant sponsor and collaborator in the field of Italian design, combining functionality of form with innovation in aesthetics.



ITA

FRA



È così che la famiglia IB si allarga e racchiude tutti i lavoratori e i collaboratori che, nel corso degli anni, hanno affrontato insieme alla famiglia Bregoli questo viaggio nella produzione industriale fondata sulla tradizione locale.

I prodotti di IB sono il frutto delle più avanzate innovazioni tecnologiche con un’attenzione al dettaglio e alla qualità tecnica ed estetica.

I prodotti di IB Rubinetti non sono solo frutto della tradizione, ma anche dell’incontro con le più avanzate innovazioni tecnologiche, e con un’attenzione al dettaglio e alla qualità tecnica ed estetica senza pari. Gli elementi innovativi si ritrovano innanzitutto nel metodo di lavorazione della materia prima. La lega d’ottone prodotta è priva di piombo e zinco, e dunque anallergica e purificata dai principali agenti contaminanti. Un ulteriore elemento rivoluzionario è la volontà di internalizzare l’intera catena produttiva: IB Rubinetti si occupa della lavorazione e produzione di ogni singolo componente dei suoi articoli da bagno, dalla materia prima fino alle più particolari finiture. Un’innovazione che non si ferma al contenuto, ma che riguarda anche la forma. Primo nella storia, IB Rubinetti si fa, fin dall’inizio degli anni Duemila, sponsor e collaboratore costante del mondo del design italiano, unendo funzionalità della forma a innovazione estetica.



C’est ainsi que la famille IB s’élargit en incluant tous les travailleurs et collaborateurs qui, au fil des années, ont affronté, à coté de la famille Bregoli, ce voyage dans une production industrielle fondée sur la tradition locale.

Les produits IB Rubinetti sont le résultat des innovations technologiques les plus avancées, soucieuses du détail et de la qualité technique et esthétique.

Les produits IB Rubinetti ne sont pas seulement le fruit de la tradition, mais aussi de la rencontre avec les innovations technologiques les plus avancées, soucieuses du détail et d’une qualité technique et esthétique sans égal. Les éléments innovants se trouvent avant tout dans la méthode de fabrication de la matière première. L’alliage de laiton produite est sans plomb ou zinc et est donc anallergique et purifié des principaux agents contaminants. Un ultérieur élément révolutionnaire est la volonté d’internaliser l’entière chaîne de production: IB Rubinetti s’occupe de la transformation et production de chaque composant pour ses articles, à partir de la matière première jusqu’aux finitions les plus particulières. Une innovation qui ne se limite pas au contenu, mais qui concerne également la forme. Première dans l’histoire, IB Rubinetti est devenue, à partir du début des années 2000, sponsor et collaborateur constant du design italien, combinant fonctionnalité et innovation esthétique.

IB Rubinetti has become a reference point for architects and designers.

Crossing all boundaries, IB deals with the most intriguing exponents of Italian excellence, opening up to numerous collaborations, driven by its sincere curiosity and genuine desire to learn from different cultures and fields. This is why IB Rubinetti has become an unquestionable and indispensable reference point for architects and designers like Maurizio Duranti, Giulio Iacchetti, Lorenzo Damiani, Remi Theberge, Marco Acerbis, Nadia Monigliardi, Antonio Gardoni, Federico Castelli and many more. The goal is always to develop high-design projects, innovative and daring in their aesthetics, but always attentive to the high functionality of the product.

The goal is always to develop high-design projects.

Therefore, our enterprise chooses the path of a design categorically made in Italy, as the only possible solution to create a future that learns from history and progresses towards new horizons.

A formula, this synthesis between tradition and innovation, functionality and aesthetic, which has also earned IB Rubinetti worldwide development and collaborations with many companies outside the national

IB Rubinetti è diventato un punto di riferimento per architetti e designer.

Valicando tutti i confini, IB si confronta con le più interessanti rappresentanze dell'eccellenza italiana aprendosi a numerose collaborazioni, spinti dalla sincera curiosità e la genuina voglia di imparare da culture e saperi differenti.

Ecco perché IB Rubinetti è diventato un punto di riferimento indiscusso e imprescindibile per architetti e designer del calibro di Maurizio Duranti, Giulio Iacchetti, Lorenzo Damiani, Remi Theberge, Marco Acerbis, Nadia Monigliardi, Antonio Gardoni, Federico Castelli e molti altri. L'obiettivo è sempre quello di sviluppare progetti di alto design, innovativi e intraprendenti nella loro estetica, ma sempre con un occhio di riguardo all'alta funzionalità del prodotto.

L'obiettivo è sempre quello di sviluppare progetti di alto design.

L'azienda sceglie così la via del design, categoricamente made in Italy, come unica soluzione possibile al fine di creare un futuro che impari dalla storia e progredisca verso nuovi orizzonti.

Una formula, questa sintesi tra tradizione e innovazione, funzionalità e qualità estetica, che è valsa a IB Rubinetti anche l'espansione globale e la collaborazione con molte realtà al di fuori dei confini nazionali,



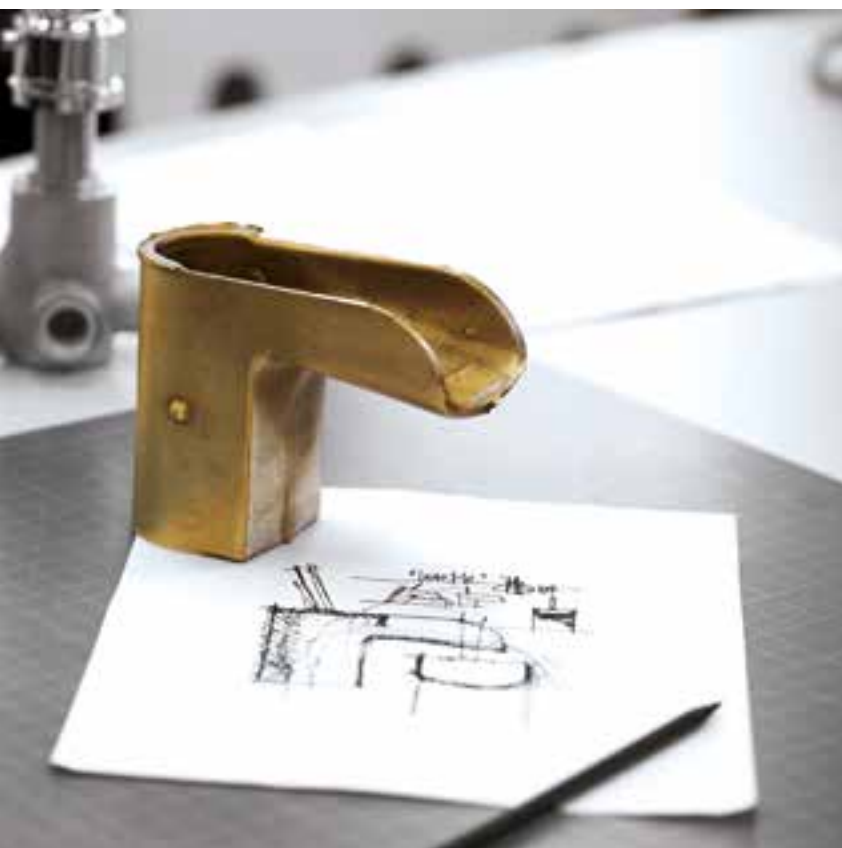

IB Rubinetti est devenu un point de référence pour architectes et designers.

Franchissant toutes les frontières, IB se mesure avec les plus intéressants représentants de l'excellence italienne et s'ouvre à de nombreuses collaborations, animée par l'authentique curiosité et le désir sincère d'apprendre par les différentes cultures et domaines. Voilà pourquoi IB Rubinetti est devenue un point de référence incontesté et indispensable pour des architectes et designers comme Maurizio Duranti, Giulio Iacchetti, Lorenzo Damiani, Remi Theberge, Marco Acerbis, Nadia Monigliardi, Antonio Gardoni, Federico Castelli et bien d'autres. L'objectif est toujours de développer des projets de haut design, innovants et entreprenants de leur esthétique, mais toujours attentifs à l'haute fonctionnalité du produit.

Le but est toujours de développer des projets de haut design.

L'entreprise choisit ainsi la voie du design, catégoriquement made in Italy, comme la seule solution possible pour créer un avenir qui tire parti de l'histoire et progresse vers de nouveaux horizons.

Une formule, cette synthèse entre tradition et innovation, fonctionnalité et qualité esthétique, qui a même valu à IB Rubinetti une expansion mondiale et une collaboration avec de nombreuses



ENG

borders, opening to the international only to underline more the intrinsic value of its product.

Operative in sixty-four countries and over five continents, the IB brand has become the ambassador of Italian design production worldwide. Learning from other cultures and suiting different economies, but always maintaining the best quality standards that Italy can offer, IB Rubinetti means to remain consistent with its identity and tradition, but also to confront and please every market needs and desires.

Operative in sixty-four countries and over five continents, the IB brand becomes the ambassador of Italian design worldwide.

If it is true that water is a source of life and renovation, this statement has never been so true for an industrial production whose trademark and productive philosophy reflects this uninterrupted flow between tradition and innovation.



MACAO
VENETIAN HOTEL - CHINA



SANTA TERESA DI GALLURA
LA COLUCCIA - ITALY



NEW YORK
PARK PLACE - USA



ITA

FRA



in un'apertura all'internazionalità che non fa che sottolineare il valore intrinseco del suo prodotto.

Presente in sessantaquattro paesi e in cinque continenti, il marchio IB si fa ambasciatore della produzione italiana di design in tutto il mondo. Imparando da altre culture e adattandosi a economie differenti, ma mantenendo sempre il migliore standard qualitativo che l'Italia possa offrire, IB Rubinetti si ripropone di rimanere sempre coerente alla sua identità e tradizione, ma anche di affrontare e soddisfare le necessità e i desideri di ogni mercato.

Presente in sessantaquattro paesi e in cinque continenti, il marchio IB si fa ambasciatore del design italiano in tutto il mondo.

Se è vero che l'acqua è fonte di vita e di rinnovamento, questa affermazione non è mai stata così vera per una produzione industriale che del flusso continuo tra tradizione e innovazione ha fatto il suo marchio di fabbrica e la sua filosofia di produzione.



entreprises hors des frontières nationales, dans une ouverture à l'internationalité ne fait que souligner la valeur intrinsèque de son produit. Présente dans soixante-quatre pays et sur cinq continents, la marque IB devient ambassadrice de la production et du design italiens dans le monde entier. Apprenant des autres cultures et s'adaptant aux différentes économies, mais toujours en maintenant les meilleurs standards de qualité que l'Italie peut offrir, IB Rubinetti compte de rester cohérent à son identité et à ses traditions, tout en faisant face aux besoins et aux désirs de chaque marché.

Présente dans soixante-quatre pays et sur cinq continents, la marque IB devient ambassadrice de la production et du design italiens dans le monde entier.

S'il est vrai que l'eau est une source de vie et de renouveau, cette affirmation n'a jamais été si vraie que pour une production industrielle qui a construit sa marque et sa philosophie productive sur le flux continu entra tradition et innovation.



SCIACCA
VERDURA GOLF SPA RESORT - ITALY

20°

EUROPE

30°



PINZOLO-TRENTO
LEFAY RESORT DOLOMITI - ITALY



MADRID
THE PAVILLIONS HOTEL - SPAIN



LUGANO
THE VIEW - SWITZLAND



BARCELONA
HOTEL JAZZ - SPAIN



BERGAMO
RELAIS S. LORENZO - ITALY



IBIZA
DESTINO RESORT - SPAIN



TEL-AVIV
THE NISHI - ISRAEL



DUBAI
FAIRMONT HOTEL - MIDDLE EAST



DUBAI
AL BANDAR ROTANA - MIDDLE EAST



DUBAI
AL BARARI VILLAS - MIDDLE EAST

60°

ASIA

120°



TOKYO
PARK HYATT HOTEL - JAPAN

130°

ASIA

170°



BUSAN
PARK HYATT HOTEL - SOUTH KOREA



SINGAPORE
MOVENPICK HOTEL - CHINA



SHENZHEN
INTERCONTINENTAL HOTEL - CHINA



BALI
KOMUNE RESORT AND BEACH CLUB - INDONESIA

-170°

USA

-80°



TORONTO
BISHA HOTEL BY WALLMAN ARCHITECTS WITH LENNY KRAVITZ - CANADA



MONTREAL
LE MERIDIEN VERSAILLES - CANADA



RECIFE
SHERATON HOTEL - BRASILE



TORONTO
MASSEY TOWER - CANADA



MAUI
ANDAZ MAUI - HAWAI

-20°

AFRICA

0°



DAKAR
ENCORE - SENEGAL



DAKAR
TAROU - SENEGAL



TANZANIA
FARU FARU LODGE - AFRICA



CAPE TOWN
FARU FARU LODGE - AFRICA

People before designers

Persone prima di designers.
Les gens avant les designers.

Acerbis



Biography

Graduated in architecture at the Milan Polytechnic in 1998, he moved immediately to London, where he worked for Lord Norman Foster until 2004, when he inaugurated his agency in Italy. Always looking for new technologies and subjects, Marco Acerbis designs avant-garde projects, always focused on environmental sustainability. Among the most important designs, we'll mention the Vertigo lamp, included in the permanent collection of the Vitra Design Museum, and two Italian buildings, certified Class A, Xellox Energy Lab and Polins.

Biografia

Laureato in architettura al Politecnico di Milano nel 1998, si trasferisce subito a Londra, dove lavora presso Lord Norman Foster fino al 2004, anno d'inaugurazione del suo studio in Italia. Alla continua ricerca di nuove tecnologie e soggetti, Marco Acerbis idea design d'avanguardia, sempre attenti alla sostenibilità ambientale. Tra i progetti più importanti, ricordiamo la lampada Vertigo, inclusa nella collezione permanente del Vitra Design Museum, e i due edifici italiani, certificati Classe A, Xellox Energy Lab e Polins.

Biographie

Diplômé en architecture à l'École polytechnique de Milan en 1998, il s'installe immédiatement à Londres, où il travaille chez Lord Norman Foster jusqu'en 2004, année de l'inauguration de son agence en Italie. Toujours à la recherche de nouvelles technologies et de nouveaux sujets, Marco Acerbis conçoit des designs avant-gardistes et toujours attentifs à la durabilité environnementale. Parmi les projets les plus importants, citons la lampe Vertigo, figurant dans la collection permanente du Vitra Design Museum, et les deux bâtiments italiens, certifiés de classe A, Xellox Energy Lab et Polins.

Castelli



Biography

Graduated in Industrial Design, Federico Castelli began his profession in 2006 by collaborating with several design studios. In 2016 he founded his homonymous agency, specializing in numerous branches of design, from product to graphic design, from interior design to installations, claiming various collaborations with IB Rubinetti, Max Mara, Innova energie. At the centre of each project is the aesthetic element, not as an absolute ideal, but rather as the result of a dedicated and consistent work.

Biografia

Formatosi in Industrial Design, Federico Castelli nel 2006 inizia la professione collaborando con diversi studi di design. Nel 2016 fonda il suo omonimo studio specializzato nelle molteplici discipline del design, dal prodotto alla grafica, dagli interni agli allestimenti, vantando collaborazioni con IB Rubinetti, Max Mara, Innova energie. Al centro di ogni suo progetto è situato l'elemento estetico, non come un ideale assoluto, ma piuttosto come il risultato di uno lavoro assiduo e coerente.

Biographie

Diplômé en design industriel, Federico Castelli entprend sa profession en 2006, en collaborant avec plusieurs agences de design. En 2016, il fonde son agence homonyme spécialisée dans les multiples disciplines du design, à partir du design de produit jusqu'à la graphique, du design d'intérieurs aux installations, et il collabore avec IB Rubinetti, Max Mara et Innova energie. L'élément esthétique est au centre de chaque projet, non pas en tant qu'idéal absolu, mais plutôt comme le résultat d'un travail constant et cohérent.

Damiani



Biography

Born in 1972 and graduated in architecture at the Milan Polytechnic, Lorenzo Damiani has always been involved in furniture and product design, collaborating with companies like Illy Caffè, IB Rubinetti and Lavazza. He was a guest of the Triennale Design Museum with three solo exhibitions, the first in 2009 edited by M. Romanelli, the followings in 2012 by G. Castiglioni and S. Annicchiario. In the sixth edition of 2013, the Triennale entrusted him with the planning of an exhibition dedicated to the Castiglioni brothers.

Biografia

Classe 1972, laureatosi in architettura al Politecnico di Milano, Lorenzo Damiani si occupa da sempre di furniture and product design, collaborando con aziende del calibro di Illy Caffè, IB Rubinetti e Lavazza. È stato ospite del Triennale Design Museum con tre mostre personali, la prima nel 2009 curata da M. Romanelli, le successive nel 2012 a cura di G. Castiglioni e S. Annicchiario. La Triennale gli ha affidato, nella sesta edizione del 2013, l'allestimento della mostra dedicata ai fratelli Castiglioni.

Biographie

Né en 1972, diplômé en architecture à l'École polytechnique de Milan, Lorenzo Damiani s'est toujours occupé de furniture and product design, en collaborant avec des entreprises comme Illy Caffè, IB Rubinetti et Lavazza. Il a figuré dans le Triennale Design Museum avec trois expositions personnelles, la première en 2009 organisée par M. Romanelli, les suivantes en 2012 par G. Castiglioni et S. Annicchiario. Lors de la sixième édition de 2013, la Triennale lui a confié l'organisation de l'exposition dédiée aux frères Castiglioni.

Duranti



Biography

Born in Florence in 1949, Maurizio Durante graduated in Architecture at Genoa in 1976, and in this city he opened his first agency until 1987, when he moved to Milan. He works as an architect and, above all, as an Industrial designer, working for numerous companies in the household sector. Many of his designed products are included in international museums collections. He is a ten times winner of the Chicago Good Design Award and he was granted the honourable mention at the Compasso d'Oro in Milan.

Biografia

Nato a Firenze nel 1949, Maurizio Durante si laurea in Architettura a Genova nel 1976, e in questa città apre il suo primo studio fino al 1987, anno in cui si trasferisce a Milano. Si occupa di architettura, ma soprattutto di Industrial Design, progettando per numerose aziende in tutti i settori del casalingo. Numerosi prodotti da lui disegnati sono presenti nelle collezioni di musei internazionali. È dieci volte vincitore del GOOD DESIGN AWARD di Chicago ed è stato insignito della Segnalazione d'Onore al Compasso d'Oro di Milano.

Biographie

Né à Florence en 1949, Maurizio Durante obtient son diplôme d'architecture à Gênes en 1976. Il ouvre sa première agence dans cette ville jusqu'en 1987, date à laquelle il s'installe à Milan. Il s'occupe d'architecture, mais surtout de design industriel, planifiant pour de nombreuses entreprises dans tous les secteurs ménagers. De nombreux produits par lui conçus figurent dans les collections des musées internationaux. Il a remporté dix fois le Good Design Award de Chicago et il a reçu la Recommandation d'Honneur au Compasso d'Oro de Milan.



Gardoni



Biography

Born in 1972 in Brescia and graduated in Architecture in Venice in 1997, after many work experiences abroad, he created his architectural agency AG Studio in 2004, where he is specialized in interior architecture, but also in graphic and product design, communication and art direction. Its customers include Redbull, Nike, Google, Levi's, IB Rubinetti and Lever Faberger. He is also the creator of the Bogue-Profumo brand, for the design, production and distribution of artistic perfumes.

Biografia

Nato nel 1972 a Brescia e laureatosi in Architettura a Venezia nel 1997, dopo numerose esperienze di lavoro all'estero, crea nel 2004 lo studio di architettura AG Studio, dove si occupa di architettura degli interni, ma anche di design grafico e di prodotto, comunicazione e art direction. Tra i suoi clienti si enumerano Redbull, Nike, Google, Levi's, IB Rubinetti e Lever Faberger. È anche il creatore del marchio Bogue-Profumo, per l'ideazione, la produzione e la distribuzione di profumi artistici.

Biographie

Né en 1972 à Brescia et diplômé en architecture à Venise en 1997, après de nombreuses expériences de travail à l'étranger, il crée l'agence d'architecture AG Studio en 2004, où il s'occupe d'architecture et d'interior design, mais également du design graphique et de produit, de communication et de direction artistique. Parmi ses clients figurent Redbull, Nike, Google, Levi's, IB Rubinetti et Lever Faberger. Il est également le créateur de la marque Bogue-Profumo, spécialisée dans la conception, la production et la distribution de parfums artistiques.

Iacchetti



Biography

Industrial designer since 1992, Giulio Iacchetti works with well-known national brands, including Alessi, Fontana Arte and Pandora design. Acknowledged for his ability to define new object types, his design research earned him multiple recognitions. Granted two Compasso d'Oro Awards in 2001 and 2014, he was also the recipient of the 2009 Innovation Awards and, in the same year, was honoured by the Milan Triennale with a solo exhibition entitled "Disobedient Objects".

Biografia

Industrial designer fin dal 1992, Giulio Iacchetti collabora con noti marchi nazionali, tra cui Alessi, Fontana Arte e Pandora design. Riconosciuto per la sua capacità di definire nuove tipologie oggettuali, la ricerca progettuale gli è valsa numerosi premi. Insignito per due volte del Compasso d'Oro, nel 2001 e nel 2014, ottiene nel 2009 il Premio dei Premi per l'innovazione e, nello stesso anno, è onorato dalla Triennale di Milano, che ospita una sua mostra personale intitolata "Objetti disobbedienti".

Biographie

Designer industriel dès 1992, Giulio Iacchetti collabore avec de grandes marques nationales, notamment Alessi, Fontana Arte et Pandora Design. Reconnu pour sa capacité de définir de nouveaux types d'objets, la recherche lui a valu de nombreux prix. Décoré de deux prix Compasso d'Oro en 2001 et 2014, il a remporté le Prix des Prix pour l'innovation en 2009 et a été honoré la même année par la Triennale de Milan, qui a accueilli une exposition personnelle intitulée "Objets désobéissants".

IT'S NOT
ABOUT IDEAS.
IT'S MAKING
IDEAS HAPPEN.

TR

TECHINICAL REFERENCE
REFERENZE TECNICHE
REFERNCE TEQUINQUE

From the idea to the product.

The design and manufacturing processes of IB Rubinetti products take place entirely within the company: from design to engineering, from plating to assembly, each step is performed under the watchful eye and capable hands of our enterprise.

Il percorso di progettazione e fabbricazione dei prodotti IB si svolge integralmente all'interno dell'azienda: dal design all'ingegnerizzazione, dalla cromatura fino all'assemblaggio, ogni passaggio viene svolto sotto l'occhio attento e le mani esperte dei nostri operatori.

Le parcours de conception et de fabrication des produits IB Rubinetti se déroule entièrement à l'intérieur de l'entreprise: du design à l'ingénierie, du chromage à l'assemblage, chaque étape est réalisée sous les yeux vigilants et les mains expertes de notre société.

Our products are systematically submitted to a reasoned series of six specific tests, in order to assess and evaluate the high quality of our offer.

I nostri prodotti sono sistematicamente sottoposti a una serie ragionata di sei test specifici, volti a collaudare e valutare l'alta qualità della nostra offerta.

Nos produits sont systématiquement soumis à une série raisonnée de six tests spécifiques, visant à tester et évaluer la qualité élevée de notre offre.

- (A) **Dimensional test**
- (B) **Surface check**
- (C) **Surface test**
- (D) **Preassure test for bodies**
- (E) **Preassure test**
- **Open cartridge**
- **Closed cartridge**
- (F) **Cleaning**

FACTORY CERTIFICATE

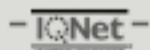

PRODUCT CERTIFICATE



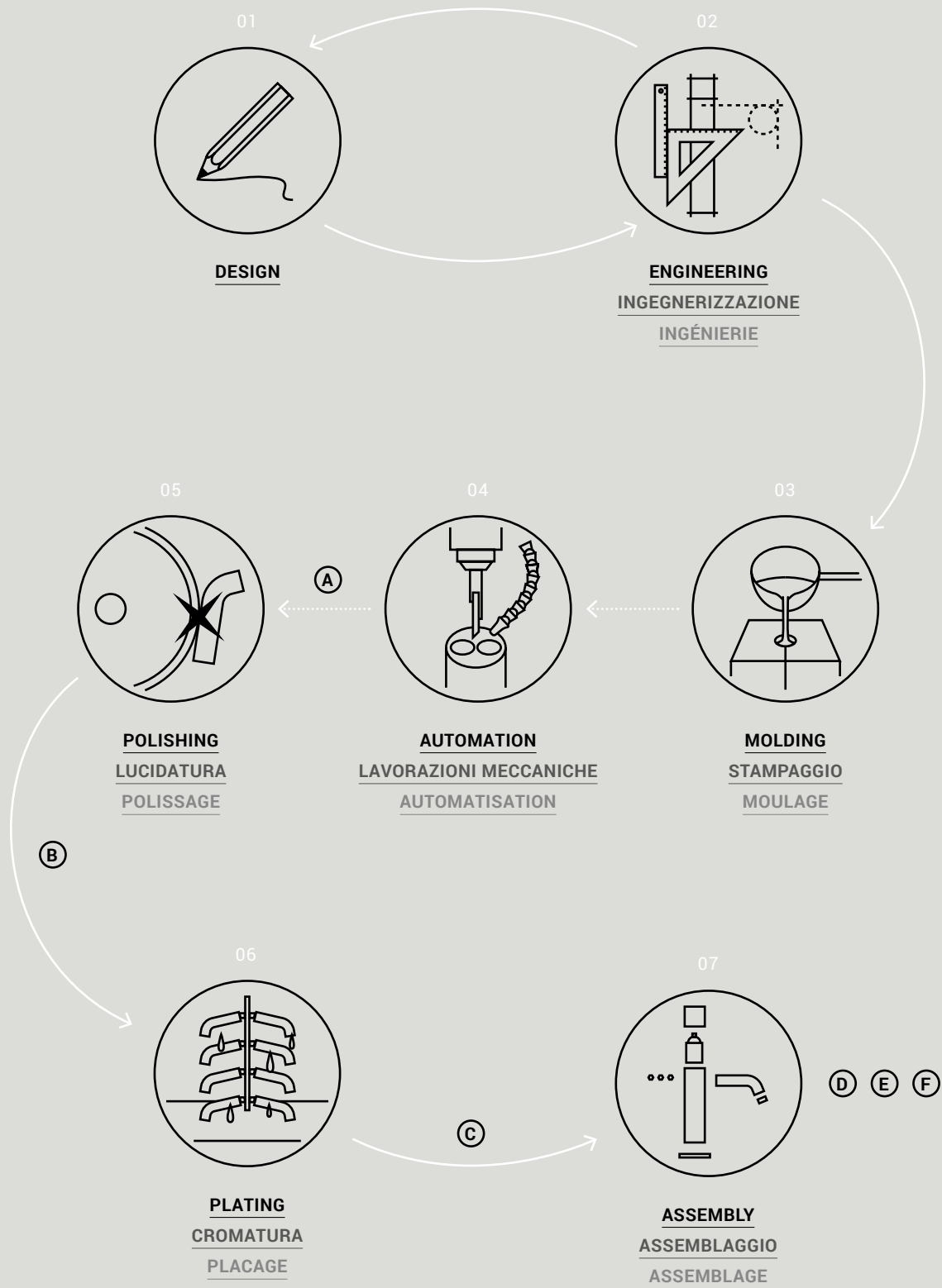

Material

IB Rubinetti uses all its expertise to promote innovation and customer care, starting from the choice of the raw material, a particular alloy of lead and zinc-free brass, which guarantees hypoallergenic and eco-friendly products.

IB Rubinetti mette tutta la sua esperienza al servizio dell'innovazione e della cura del cliente, a partire dalla scelta della materia prima, una particolare lega d'ottone priva di zinco e piombo che assicura un prodotto anallergico ed ecofriendly.

IB Rubinetti met toute son expérience au service de l'innovation et du service à la clientèle, à partir du choix de la matière première, un alliage particulier de laiton, sans zinc ou plomb, qui assure un produit anallergique et écologique.



(A) Finishes plating
Cromatura
Chromage

(B) Solid brass
Ottone
Laiton





LEAD FREE

We use only lead-free brass.

Noi usiamo solo ottone senza piombo.

Nous n'utilisons que du laiton sans Plomb.



ZINC FREE

We use only zinc-free brass.

Noi usiamo solo zinco senza piombo.

Nous n'utilisons que du laiton sans zinc.



WARRANTY

All IB Rubinetti products have a 10-years warranty.

Tutti i prodotti IB Rubinetti godono di 10 anni di garanzia.

Tous les produits IB ont une garantie de 10 ans.



ORIGIN

We only use materials from Europe.

Noi usiamo solo materiale proveniente dall'Europa.

Nous n'utilisons que des matériaux d'Europe.



CERTIFICATION

We comply with recognized world standards such as IAPMO, SITAC, CISQ, ACS.

Rispettiamo gli standard di qualità più alti al mondo come IAPMO, SITAC, CISQ, ACS.

Nous nous conformons à des standards mondialment reconnus tels IAPMO, SITAC, CISQ, ACS.



ENVIRONMENT

The production cycle respects the highest environmental standards.

Il ciclo produttivo rispetta i più alti standard ambientali.

Notre cycle de production respecte des standards environnementaux des plus hauts niveaux.

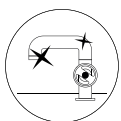

FINISHES

16 different finishes available.

16 differenti finiture disponibili.

16 différentes finitions disponible.

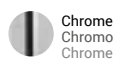

Chrome
Cromo
Chrome

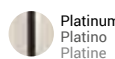

Platinum
Platino
Platine

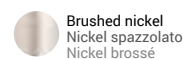

Brushed nickel
Nickel spazzolato
Nickel brossé

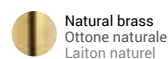

Natural brass
Ottone naturale
Laiton naturel



Matt white
Bianco opaco
Blanc mat



Matt black
Nero opaco
Noir mat



Black chrome
Black chrome
Black chrome

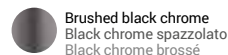

Brushed black chrome
Black chrome spazzolato
Black chrome brossé

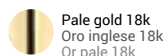

Pale gold 18k
Oro inglese 18k
Or pale 18k



Brushed pale gold 18k
Oro inglese spazzolato 18k
Or pale brossé 18k

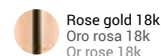

Rose gold 18k
Oro rosa 18k
Or rose 18k

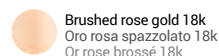

Brushed rose gold 18k
Oro rosa spazzolato 18k
Or rose brossé 18k



Gold 22k
Oro 22k
Or 22k

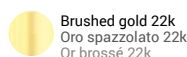

Brushed gold 22k
Oro spazzolato 22k
Or brossé 22k

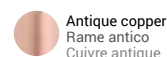

Antique copper
Rame antico
Cuivre antique



Antique bronze
Bronzo antico
Bronze antique

IB BOX

The brilliant way to think about water.

Il modo più geniale per ragionare l'acqua.
La façon la plus géniale de raisonner l'eau.

IB BOX is a universal water mixing system, ready to transform the traditional way of imagining the bathroom. Preliminarily fixed to the wall and adaptable to any IB Rubinetti collection, for faucets or showers, it guarantees thin and light appliances and an absolute and immediate creative freedom.

IB BOX è un sistema universale per la miscelazione dell'acqua, pronto a rivoluzionare il modo tradizionale di pensare il bagno. Preliminarmente montato a muro e adattabile a qualsiasi collezione IB Rubinetti, da lavabo o doccia, garantisce apparecchiature esili e leggere e una libertà creativa assoluta e immediata.

IB BOX est un système universel de mixage de l'eau, prêt à révolutionner la manière traditionnelle de penser à la salle de bain. Installé au mur de façon préliminaire et adaptable à toute collection IB Rubinetti, évier ou douche, il garantit un appareil mince et léger ainsi qu'une liberté de création absolue et immédiate.





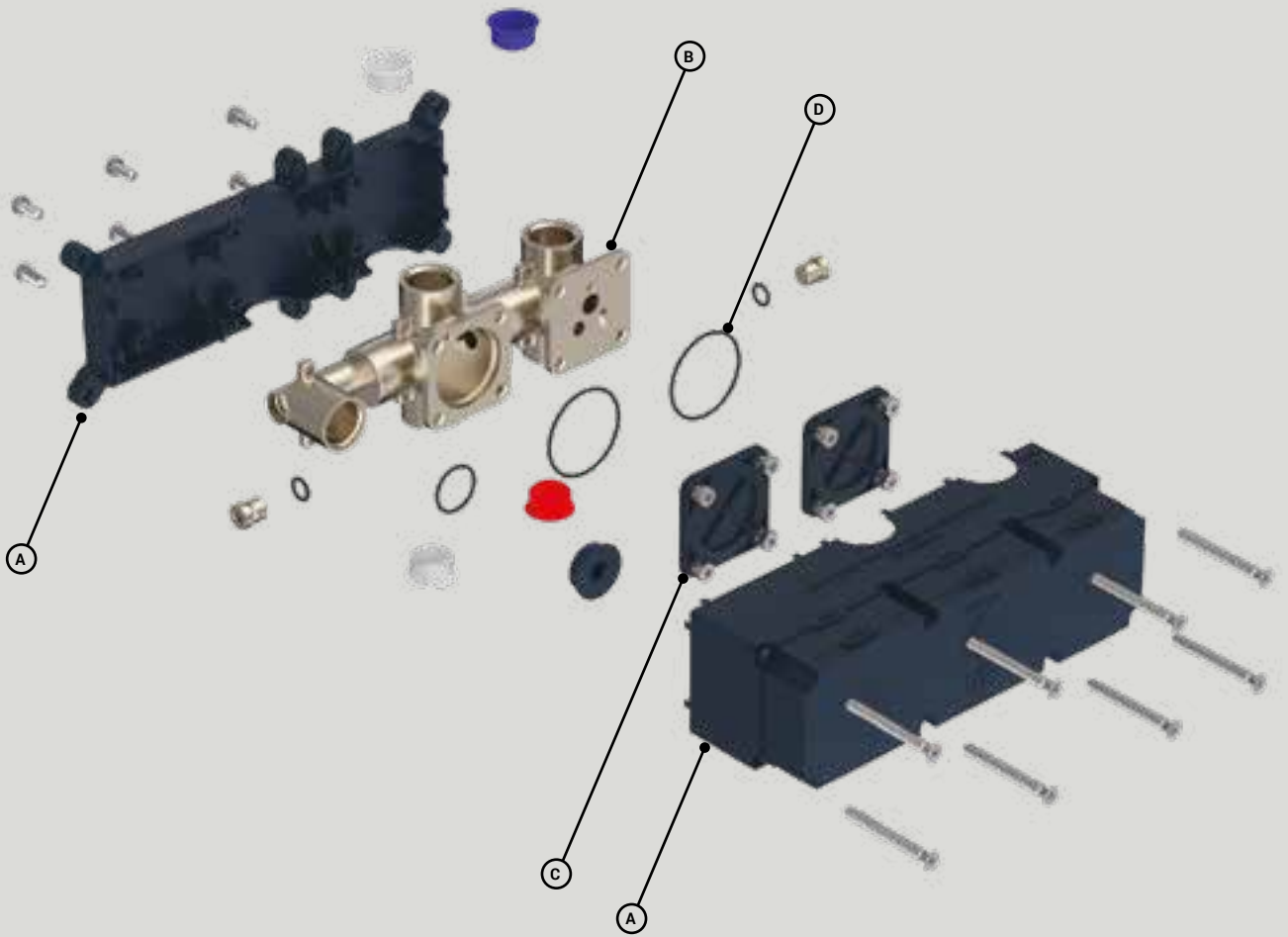

- A** **A front and back plastic case,**
C **equipped with plastic protection**
caps, encloses and protects a brass
B **body, which allows the connection to**
the hydraulic system of the external
components through specific
D **seals, adaptable to any IB Rubinetti**
product on the market.

Un case in plastica (A) frontale e posteriore, fornito di tappi di protezione (C) anch'essi in plastica, racchiude e protegge al suo interno un corpo in ottone (B), che permette l'allaccio all'impianto idraulico delle componenti esterne tramite guarnizioni (D) adattabili a qualsiasi prodotto IB Rubinetti sul mercato.

Un case en plastique (A) antérieur et postérieur, muni de capsules de protection (C) elle aussi en plastique, contient et protège un corps en laiton (B), qui permet le raccordement au circuit hydraulique des composants extérieures à travers des joints (D) adaptables à tout produit IB Rubinetti sur le marché.

Features +

A handy and intuitive system, allowing the maximum performative efficiency and an easy implementation during assembly.

Un sistema comodo e intuitivo, che permette la massima efficienza performativa e una facile applicazione in fase di montaggio.

Un système pratique et intuitif qui permet la meilleure efficacité performative et une application simple en cours de montage.

+ QUICK INSTALLATION

Set up in just a few simple steps, it acts as a universal link for the connection to the hydraulic system.

INSTALLAZIONE RAPIDA

Installabile in poche semplici mosse, funge da tramite universale per l'allaccio all'impianto idraulico.

INSTALLATION RAPIDE

Installé en quelques étapes simples, il sert de lien universel pour la connexion au système hydraulique.

+ EFFICIENT

A unique product, of minimal dimensions and easy to install, which will make the bathroom design practical and fast.

EFFICIENTE

Un prodotto unico, di dimensioni minime e di facile installazione, che renderà la progettazione del bagno pratica e veloce.

EFFICACE

Un produit unique, de dimensions minimales et facile à installer, qui rendra la planification de la salle de bain pratique et rapide.

+ SAFE

The best safety standards are respected, in order to guarantee an efficient and reliable product.

SICURO

Sono rispettati i migliori standard di sicurezza per garantire un prodotto efficiente e affidabile.

SÉCURISÉ

Les meilleures normes de sécurité sont respectées pour garantir un produit efficace et fiable.

+ INTUITIVE

The intuitive device installation provides, in just a few simple steps, a ready-to-use connection support.

INTUITIVO

L'intuitiva installazione dell'apparecchiatura fornisce, in pochi semplici gesti, una base d'allaccio pronta all'utilizzo.

INTUITIF

L'installation intuitive de l'appareil fournit, en quelques étapes simples, une base de connexion prête à l'emploi.

+ EASY MAINTENANCE

The single and compact structure ensures a convenient and rapid maintenance of the system.

MANUTENZIONE COMODA

La struttura singola e compatta assicura un sistema dalla manutenzione comoda e istantanea.

MAINTENANCE PRATIQUE

La structure unique et compacte garantit un système du maintien pratique et instantané.

+ IMMEDIATE AVAILABILITY

The universal system allows to keep a single body in stock for all collections, thus optimizing storage space and ensuring versatility in distribution.

DISPONIBILITÀ IMMEDIATA

Il sistema universale permette di tenere in magazzino un unico corpo per tutte le collezioni, ottimizzando così lo spazio di stoccaggio e garantendo versatilità nella distribuzione.

DISPONIBILITÉ IMMÉDIATE

Le système universel permet de garder en stock un seul corps pour toutes les collections, optimisant ainsi l'espace de stockage et garantissant versatilité dans la distribution.



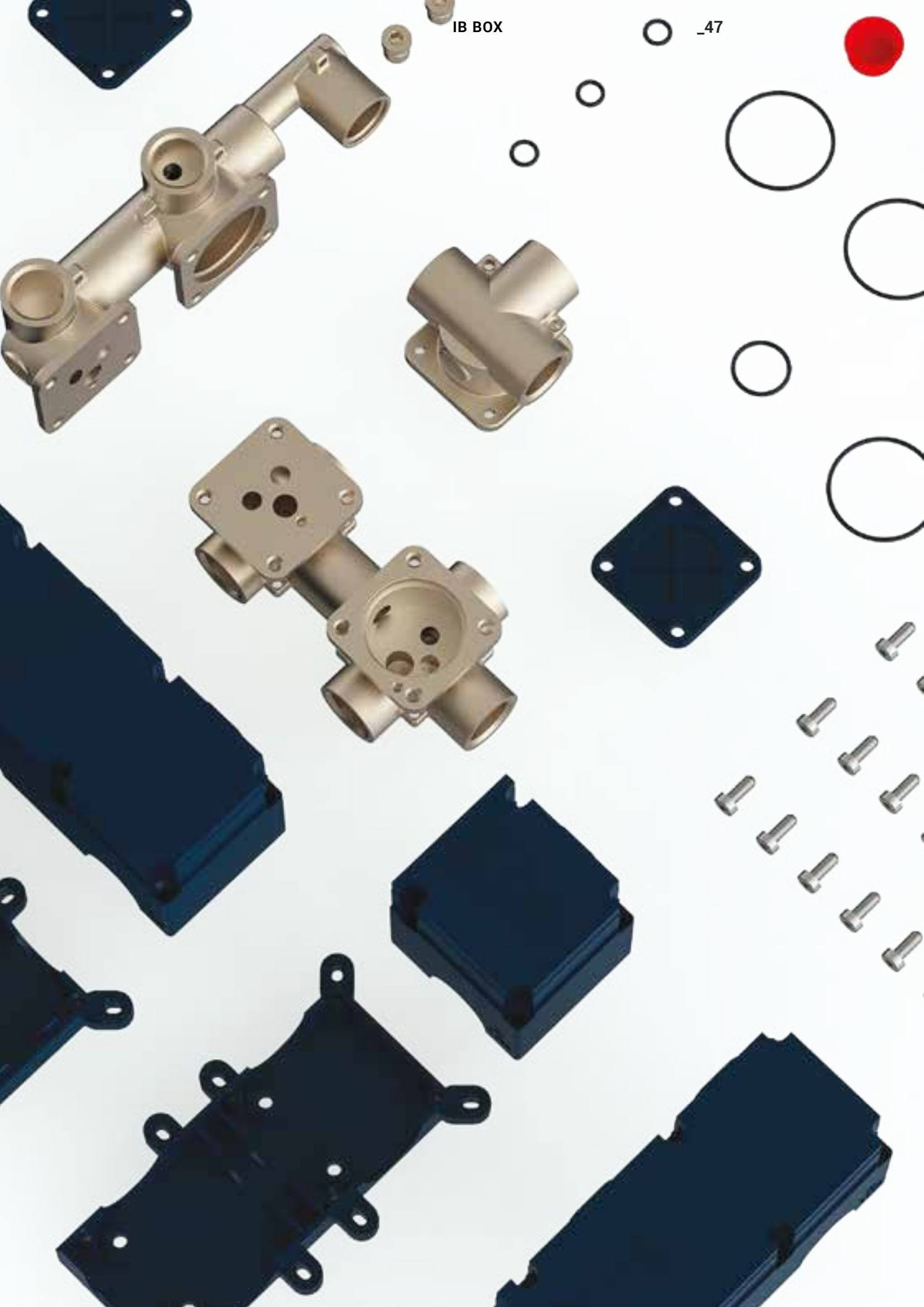

The form follows the function

IB Box is not only content but also form, and guarantees multiple aesthetic advantages, exceptional in their simplicity.

IB Box non è solo contenuto ma anche forma, e garantisce dei vantaggi estetici formidabili nella loro essenzialità.

IB Box n'est pas que du contenu mais il est aussi forme, et il garantit des avantages esthétiques extraordinaires dans leur essentialité.

+ MINIMUM DIMENSION

The space occupied by the technical compartment is minimal, thus ensuring in its external controls a complete and self-contained product.

MINIME DIMENSIONI

Lo spazio occupato dal comparto tecnico è minimo, assicurando così nei comandi esterni un prodotto completo e contenuto nella forma.

DIMENSIONS MINIMALES

L'espace occupé par le département technique est minimal, assurant ainsi, dans les contrôles externes, un produit complet et de forme contenue.

+ SUPER-THIN PLATE

Not only the built-in part, but also the external plates have been redesigned in order to reduce their size, making them extremely thin, elegant and perfectly integrated with the surrounding environment.

PLACCA SUPERSOTTILE

Non solo la parte incassata, ma anche le placche esterne sono state riprogettate per diminuire le dimensioni, rendendole estremamente sottili, eleganti e perfettamente integrate all'ambiente circostante.

PLAQUE SUPER-FINE

Non seulement la partie incorporé, mais également les plaques externes ont été repensées afin de réduire leur taille, ce qui les rend extrêmement fines, élégantes et parfaitement intégrées au milieu environnant.

+ COMPATIBILITY WITH EVERY COLLECTION

The universal system guarantees absolute compatibility with any IB Rubinetti collection, implementing new types of aesthetic plates adaptable to every series.

COMPATIBILITÀ CON TUTTE LE SERIE

Il sistema universale garantisce una compatibilità assoluta con qualsiasi collezione IB Rubinetti, implementando su di esse delle nuove tipologie di placche estetiche.

COMPATIBILITÉ AVEC TOUTES LES COLLECTIONS

Le système universel garantit une compatibilité absolue avec toutes les collections IB Rubinetti, à travers la mise en œuvre de nouveaux types de plaques esthétiques.

+ ENCOURAGING THE CREATIVE PROJECT

Thanks to its universal formula, it allows to unleash your creativity, satisfying every desire and freeing from the obligation to make the aesthetic choice during the technical installation.

ANIMA IL PROGETTO CREATIVO

Grazie alla sua formula universale permette di dare libero sfogo alla creatività, soddisfacendo ogni desiderio e liberando dall'obbligo di dover compiere la scelta estetica nel momento dell'installazione tecnica.

ANIMER LE PROJET CRÉATIF

Grâce à sa formule universelle, il permet d'assouvir librement la créativité, de satisfaire tout désir et de libérer de la nécessité de faire le choix esthétique lors de l'installation technique.





Simple but effective

In six simple steps, IB Box will be ready to ensure, immediately and in total safety, the essential support to all desires.

In sei semplici passi, IB Box sarà pronto ad assicurare, con immediatezza e in completa sicurezza, il supporto necessario a ogni desiderio.

En six simples étapes, IB Box sera prêt à assurer, avec promptitude et en toute sécurité, le support nécessaire à chaque désir.



The plastic case, which encloses and protects the brass heart, is directly secured to the rough plaster through a system of wall plugs.

Il case in plastica, che racchiude e protegge il cuore in ottone, viene direttamente assicurato all'intonaco grezzo attraverso un sistema di viti tassello.
Le case en plastique, qui entoure et protège le cœur en laiton, est directement fixé au plâtre brut à l'aide d'un système de vis à cheville.



Once fixed, it is connected to the bathroom hydraulic system in a simple and intuitive way, especially thanks to the instructions directly reported on the case, providing all the essential information.

Una volta fissato, esso viene collegato al sistema idraulico del bagno in modo semplice e intuitivo, grazie anche alle istruzioni direttamente riportate sul case, che forniscono tutte le indicazioni necessarie.
Une fois fixé, il est branché au système hydraulique de la salle de bain de manière simple et intuitive, grâce aux instructions affichées directement sur le case, qui fournissent toutes les informations nécessaires.



After having connected it to the hydraulic system, it is possible to proceed to the masonry work. The material chosen to decorate the wall will cover the equipment, leaving only the front case visible.

Dopo averlo allacciato al sistema idraulico, si può procedere al lavoro di muratura. Il materiale scelto per ornare la parete andrà a coprire l'apparecchiatura, lasciando visibile solo il coperchio anteriore.
Après l'avoir connecté au système hydraulique, il est possible de procéder aux travaux de maçonnerie. Le matériau choisi pour décorer le mur couvrira le dispositif, en ne laissant visible que le couvercle antérieur.

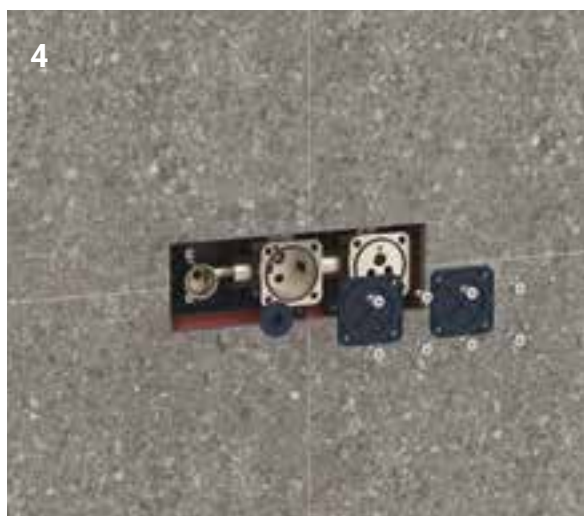

Once the work is completed, IB Box will be ready to use: you will simply have to remove the plastic cover to find inside the brass heart, ready for installation, perfectly flush with the wall.

A lavori ultimati, IB Box sarà pronto per essere utilizzato: basterà sfilare la copertura in plastica per ritrovare all'interno, perfettamente a raso parete, il cuore in ottone necessario all'installazione del prodotto.
Une fois les travaux terminés, IB Box sera prêt à être utilisé: il suffira de enlever la couverture en plastique pour y trouver à l'intérieur le cœur en laiton nécessaire à l'installation du produit, parfaitement au ras du mur.



5

The body of IB Box will therefore act as a connection base, to be completed with all the required seals, depending on the type of IB Rubinetti product desired.

Il corpo di IB Box fungerà quindi da base di allaccio, da completare con tutti le guarnizioni necessarie a seconda della tipologia di prodotto IB Rubinetti desiderato.

Le corps de IB Box servira donc de base de connexion, à compléter avec tous les joints nécessaires, en fonction du type de produit IB Rubinetti souhaité.



6

The super-thin plaque will then easily cover the connections, guaranteeing an elegant product, delicate in its simplicity and lightness, always ready to satisfy all the creative desires and inspirations.

La placca supersottile andrà poi facilmente a coprire gli allacci, garantendo un prodotto elegante e delicato per la sua semplicità e leggerezza, sempre pronto a soddisfare tutte le esigenze e gli estri creativi.

La plaque ultrafine couvrira alors facilement les connexions, garantissant un produit élégant et délicat par sa simplicité et à sa légèreté, toujours prêt à satisfaire tout besoin et toute fantaisie créative.

SHOWER | DOCCIA | DOUCHE

●
1 WAY
1 USCITA
1 VOIE

CODE / COEFFICIENT | CODICE /
 COEFFICIENTE | CODE / COEFFICIENT

INC300XXN_19 1,8



DIMENSIONS | DIMENSIONI | DIMENSIONS

84 x 74 x 82

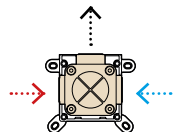

BUILT-IN | INCASSO | ENCASTRÉ

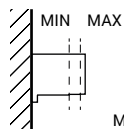

MIN : 57.5 mm
 MAX : 74.5 mm

PACKAGING

📦 L: 90 mm ⚖️ 0,52 kg
 D: 80 mm
 H: 90 mm

CONTROL | COMANDI | CONTROLLE

One way wall shower mixer
 Miscelatore doccia a parete una via
 Mitigeur douche mural 1 voie



● ●
2 WAYS
2 USCITE
2 VOIES

CODE / COEFFICIENT | CODICE /
 COEFFICIENTE | CODE / COEFFICIENT

INC310XXN_19 3,3



DIMENSIONS | DIMENSIONI | DIMENSIONS

84 x 149 x 82

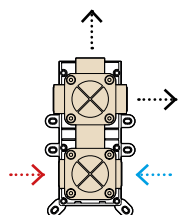

BUILT-IN | INCASSO | ENCASTRÉ

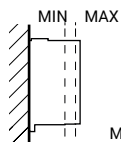

MIN : 57.5 mm
 MAX : 74.5 mm

PACKAGING

📦 L: 165 mm ⚖️ 1,1 kg
 D: 90 mm
 H: 85 mm

CONTROL | COMANDI | CONTROLLE

Two ways wall shower mixer
 Miscelatore doccia a parete con
 deviatore due vie
 Mitigeur douche mural 2 voies avec
 inverseur



● ● ●
3 WAYS
3 USCITE
3 VOIES

CODE / COEFFICIENT | CODICE /
 COEFFICIENTE | CODE / COEFFICIENT

INC312XXN_19 3,3



DIMENSIONS | DIMENSIONI | DIMENSIONS

84 x 149 x 82

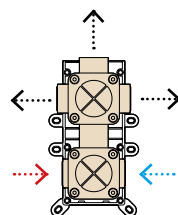

BUILT-IN | INCASSO | ENCASTRÉ

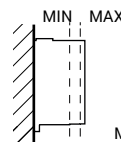

MIN : 57.5 mm
 MAX : 74.5 mm

PACKAGING

📦 L: 165 mm ⚖️ 1,08 kg
 D: 90 mm
 H: 85 mm

CONTROL | COMANDI | CONTROLLE

Three ways wall shower mixer
 Miscelatore doccia a parete con
 deviatore tre vie
 Mitigeur douche mural 3 voies avec
 inverseur



● ●
2 WAYS
2 USCITE
2 VOIES

CODE / COEFFICIENT | CODICE /
 COEFFICIENTE | CODE / COEFFICIENT

INC313XXN_19 3,6



DIMENSIONS | DIMENSIONI | DIMENSIONS

84 x 216 x 82

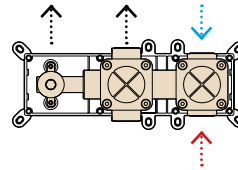

BUILT-IN | INCASSO | ENCASTRÉ

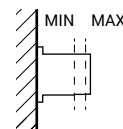

MIN : 57.5 mm
 MAX : 74.5 mm

PACKAGING

📦 L: 230 mm ⚖️ 1,3 kg
 D: 90 mm
 H: 85 mm

CONTROL | COMANDI | CONTROLLE

Two ways wall shower mixer complete
 with shower kit
 Miscelatore doccia a parete con
 deviatore due vie e doccia integrato
 Mitigeur douche mural 2 voies avec
 inverseur et douchette encastrée



• • •

3 WAYS
3 USCITE
3 VOIES

CODE / COEFFICIENT | CODICE / COEFFICIENTE |
CODE / COEFFICIENT

INC314XXXN_19 3,7



DIMENSIONS | DIMENSIONI | DIMENSIONS

84 x 216 x 82

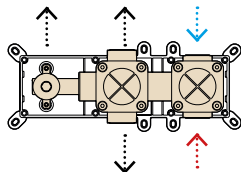

BUILT-IN | INCASSO | ENCASTRÉ

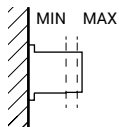

MIN : 57.5 mm
MAX : 74.5 mm

PACKAGING

L: 230 mm 1,28 kg
D: 90 mm
H: 85 mm

CONTROL | COMANDI | CONTROLLE

Three ways wall shower mixer complete with shower kit

Miscelatore doccia a parete con deviatore tre vie e doccia integrato

Mitigeur douche mural 3 voies avec inverseur et douchette encastrée



•

1 WAY
1 USCITA
1 VOIE

CODE / COEFFICIENT | CODICE / COEFFICIENTE |
CODE / COEFFICIENT

INC206XXXN_19 2,9



DIMENSIONS | DIMENSIONI | DIMENSIONS

84 x 216 x 82

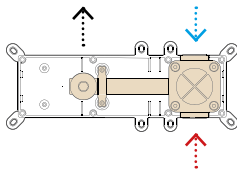

BUILT-IN | INCASSO | ENCASTRÉ

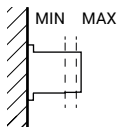

MIN : 57.5 mm
MAX : 74.5 mm

PACKAGING

L: 230 mm 0,8 kg
D: 90 mm
H: 85 mm

CONTROL | COMANDI | CONTROLLE

Wall mounted washbasin mixer

Miscelatore lavabo due fori a parete

Mitigeur lavabo mural



•

1 WAY
1 USCITA
1 VOIE

CODE / COEFFICIENT | CODICE / COEFFICIENTE |
CODE / COEFFICIENT

INC206XXXN_19 2,9



DIMENSIONS | DIMENSIONI | DIMENSIONS

84 x 216 x 82

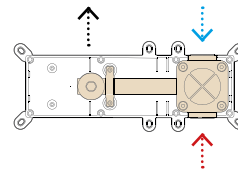

BUILT-IN | INCASSO | ENCASTRÉ

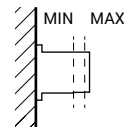

MIN : 57.5 mm
MAX : 74.5 mm

PACKAGING

L: 230 mm 0,8 kg
D: 90 mm
H: 85 mm

CONTROL | COMANDI | CONTROLLE

Shut off

Idroscopino

Ensemble hygiénique





Interactive PDF, you can view the collection directly by clicking on it.
PDF interattivo, per visualizzare direttamente la collezione basta cliccarci sopra.
PDF interactif, vous pouvez voir la collection directement en cliquant dessus.



**BOLD ROUND
BOLD LEVER**
P. 56



**MARMO
MARMO L**
P. 88



INDUSTRIA
P. 120



TAAAC
P. 146



K2
P. 166



K3
P. 188



LOVE ME
P. 208



**BELMONDO
BELMONDO ELLE**
P. 234



TWITTER
P. 284



WAVE
P. 262



SUPERBOX
P. 304



MILANOTORINO
P. 322



BATLÒ
P. 346



ONLY ONE
P. 370



RUBACUORI
P. 394



HEY JOE!
P. 418



WOW
P. 442



BIRKIN
P. 454



**HERMES
HERMES ELLE**
P. 468



**KUSASI
KUSASI SHORT**
P. 496



POWA
P. 518



BYE BYE
P. 520

BH

BATHROOM
BAGNO
BAIN

BOLD ROUND & LEVER

The faucet collection for character spaces.

La collezione di rubinetti per ambienti di carattere.

La collection de robinets pour les espaces de caractères.

Inspired by the traditional forms of the industrial faucet, the BOLD collection is marked by solid outlines and essential and functional forms, making it the better choice for spaces with strong features and personality. Available in ten different finishes and in two varieties of lever, Bold reinvents a regular design by capturing its essence and renovating it with the addition of little peculiar details, for a collection design bold like its name.

Ispirata alle forme tradizionali del rubinetto industriale, la collezione BOLD è contraddistinta da contorni robusti e forme essenziali e funzionali, che la rendono adatta ad ambienti dal forte carattere e dalla personalità decisa. Disponibile in dieci differenti finiture e in due varietà di leva, Bold reinventa un design consueto catturandone l'essenza e rinnovandola tramite l'aggiunta di piccoli particolari non ordinari, per un design audace come il suo nome.

Inspirée à les formes traditionnelles du robinet industriel, la collection BOLD se caractérise par des contours solides et des formes essentielles et fonctionnelles, qui la rendent apte aux environnements au caractère et personnalité forts. Disponible en dix finitions différentes et en deux typologies de poignée, Bold réinvente un design coutumier, en capturant son essence, en le renouvelant par l'adjonction de détails qui ne sont pas ordinaires et en créant ainsi un design audacieux comme son nom.



KITCHEN
AVAILABLE



DOUBLE LEVER



LEAD FREE



ZINC FREE





The BOLD collection is the perfect combination of elemental elements reinterpreted in a contemporary way.

La collezione BOLD è la perfetta combinazione di elementi elementari, reinterpretati in chiave contemporanea.

La collection BOLD est la combinaison parfaite d'éléments élémentaires réinterprétés de façon contemporaine.

“ We have been fascinated by the utilitarian design of industrial valves taps, their proportions and strong features have been a great source of inspiration. At the same time we wanted to counterbalance this heavy look with an extremely refined range of finishes spanning going from matte black to natural brass and an extremely precise knurl etching on the grip connection details. The BOLD collection is the perfect combination of elemental elements reinterpreted in a contemporary way to suit a large spectrum of bathroom styles and a precise clear statement about water control.

Siamo rimasti affascinati dal design funzionale delle valvole industriali dei rubinetti, le loro proporzioni e il loro carattere deciso sono stati una fondamentale fonte di ispirazione. Allo stesso tempo, volevamo controbilanciare questo look duro con una gamma altamente raffinata di finiture, che spaziano dal nero opaco all'ottone naturale, e di zigrinature incise sui dettagli delle manopole. La collezione BOLD è la combinazione perfetta di elementi elementari, reinterpretati in chiave contemporanea per adattarsi a un ampio spettro di stili, e una precisa dichiarazione d'intenti riguardo al controllo dell'acqua

Nous avons été fascinés par le design fonctionnel des valves de la robinetterie industrielle. Leurs proportions et leur caractère résolu ont été une grande source d'inspiration. En même temps, nous voulions contrebalancer ce heavy look avec l'ajoute d'une gamme de finitions extrêmement raffinées, allant du noir mat au laiton naturel, et de gravures moletées sur les détails des manettes. La collection BOLD est la combinaison parfaite d'éléments élémentaires, réinterprétés de façon contemporaine pour s'adapter à un large éventail de styles, et une déclaration claire de nos intentions au sujet du contrôle de l'eau. ”

Federico Castelli & Antonio Gardoni design for BOLD



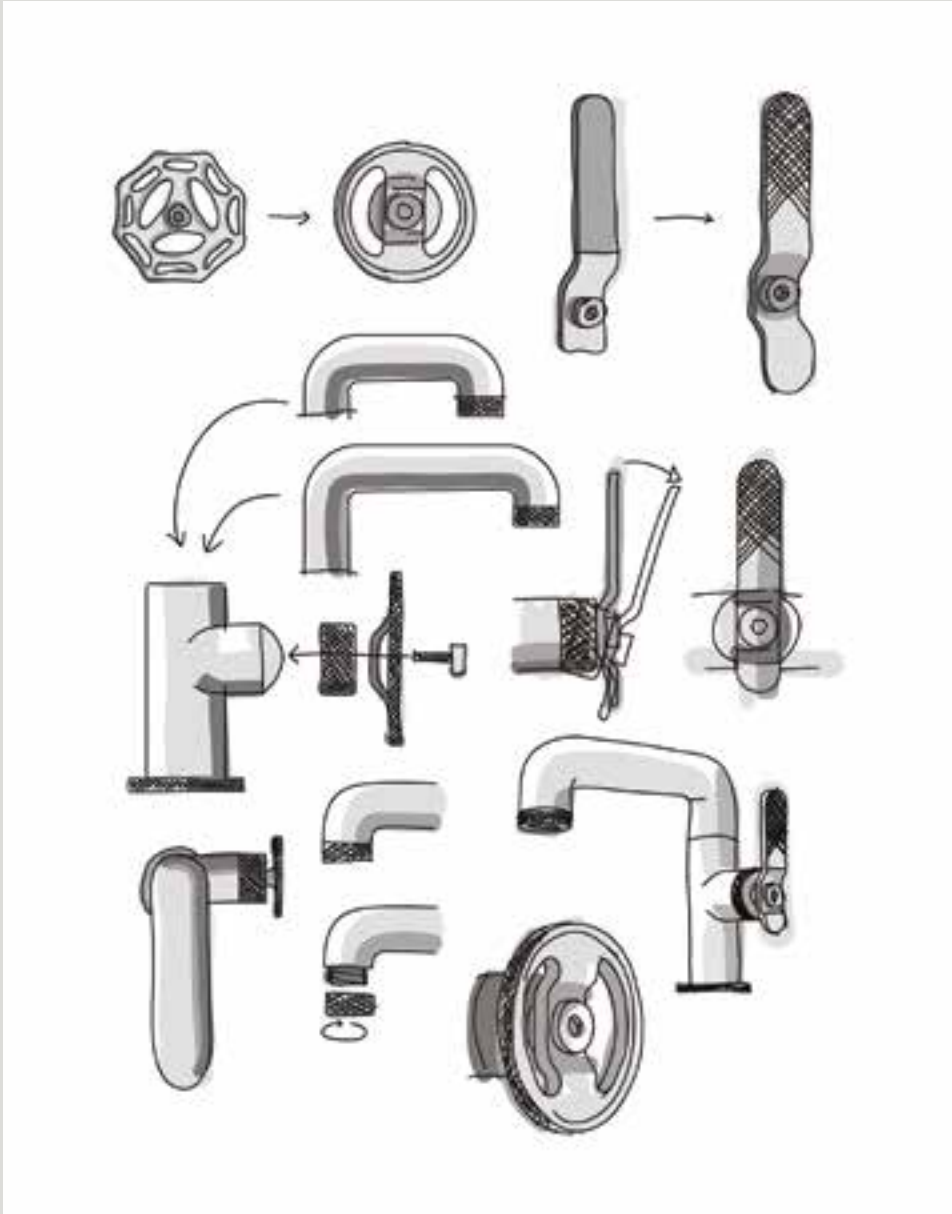



- ↑ **B2209CC_6**
 Mono hole wall mounted washbasin mixer
 Miscelatore lavabo a parete monoforo
 Mitigeur lavabo mural monotrou
- ↙ **B1205CC**
 Monohole washbasin with two handles
 Lavabo monoforo con due leve
 Lavabo monotrou mélangeur
- **B2202SS**
 Tall monohole washbasin mixer
 Miscelatore lavabo monoforo alto
 Mitigeur lavabo Haut







↑ B1390SS
Three holes washbasin set with tall spout
Lavabo tre fori bocca alta
Lavabo trois trous bec haut

→ B1200NP
Monohole washbasin mixer
Miscelatore lavabo monoforo
Mitigeur lavabo

← B2200SS
Monohole washbasin mixer
Miscelatore lavabo monoforo
Mitigeur lavabo







← B1306CC_6
Wall mounted washbasin mixer
Miscelatore lavabo due fori a parete
Mítigeur lavabo mural

↑ B2390CC
Three holes washbasin set with tall spout
Lavabo tre fori bocca alta
Lavabo trois trous bec haut

→ B1392ON
Three holes washbasin set with low spout
Lavabo tre fori bocca bassa
Lavabo trois trous bec bas





↖ **B2312CC**
Exposed parts for manual wall mixer with three ways diverter
 Set di parti esterne per miscelatore a parete a tre vie
 Partie extérieure pour mitigeur encastré à trois voies

← **B2410CC**
Three holes wall mounted shower with two ways diverter
 Tre rubinetti a parete per doccia con deviatore a due vie
 Mélangeur trois trous douche avec inverseur deux voies

→ **B2314CC**
Exposed parts for manual wall mixer with three ways diverter complete with shower kit
 Set di parti esterne per miscelatore a parete a tre vie completo di kit doccia
 Partie extérieure pour mitigeur encastré à trois voies avec douchette





← KB18000
 Thermostatic valve shower control detail
 Dettaglio del comando termostatico doccia
 Détail du contrôle thermostatique de la douche

A Thermostatic valve
 Valvola termostatica
 Valve thermostatique

B Water flow regulation
 Regolazione flusso d'acqua
 Régulation débit d'eau

→ KB1800CS
 Shower column with mixer and shower kit
 Colonna doccia con miscelatore con kit doccia
 Colonne de douche avec mitigeur et kit douche

↓ Showerhead detail
 Dettaglio del soffione doccia
 Détail de la tête de la douche







← KB170000

Free-standing two columns bath filler with shower kit
 Bordo vasca da terra a doppia colonna con kit doccia
 Mélangeur bain/douche complet avec alimentation sol

Bold

Diverter integrated with PULL and TURN system
 Deviatore integrato con sistema PULL and TURN
 Déviateur intégré avec système PULL AND TURN

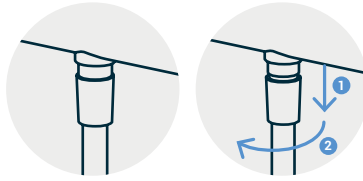

↑ KB2398CC

Five holes wall mounted bath filler with shower kit
 Bordo vasca a parete cinque fori con deviatore e kit doccia
 Bain/douche cinq trous avec inverseur et kit douche

- | | |
|---|--|
| A Hot water
Acqua calda
Eau chaude | D Diverter
Deviatore
Déviateur |
| B Spout
Bocca d'erogazione
Bec | E Hand shower
Doccino
Douchette |
| C Cold water
Acqua fredda
Eau froide | |

ARTICLE | ARTICOLO | ARTICLE

B1200



Monohole washbasin mixer complete with drain

Miscelatore lavabo monoforo completo di scarico automatico

Mitigeur lavabo complet avec bonde automatique

CODE / COEFFICIENT | CODICE /
COEFFICIENTE | CODE / COEFFICIENT

● CC	B1200CC	11,1
● SS	B1200SS	13,9
● ON	B1200ON	11,1
● NP	B1200NP	13,3
● CF	B1200CF	16,7
● CS	B1200CS	17,8
● II	B1200II	16,7
● IS	B1200IS	17,8
● RS	B1200RS	16,7
● SR	B1200SR	17,8
● OO	B1200OO	16,7
● OS	B1200OS	17,8

.6 LEVA ROSSA | RED
LEVER | LEVIER ROUGE + 0,1

PACKAGING

L: 240 mm
D: 215 mm
H: 110 mm

2,5 kg

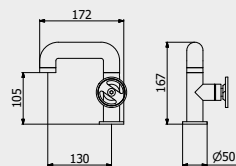

PORTATE | WATER FLOW | DÉBIT D'EAU

1 BAR	2 BAR	3 BAR
3 l/m	4,4 l/m	4,5 l/m

ARTICLE | ARTICOLO | ARTICLE

B2200



Monohole washbasin mixer complete with drain

Miscelatore lavabo monoforo completo di scarico automatico

Mitigeur lavabo complet avec bonde automatique

CODE / COEFFICIENT | CODICE /
COEFFICIENTE | CODE / COEFFICIENT

● CC	B2200CC	11,1
● SS	B2200SS	13,9
● ON	B2200ON	11,1
● NP	B2200NP	13,3
● CF	B2200CF	16,7
● CS	B2200CS	17,8
● II	B2200II	16,7
● IS	B2200IS	17,8
● RS	B2200RS	16,7
● SR	B2200SR	17,8
● OO	B2200OO	16,7
● OS	B2200OS	17,8

.6 LEVA ROSSA | RED
LEVER | LEVIER ROUGE + 0,1

PACKAGING

L: 240 mm
D: 215 mm
H: 110 mm

2,5 kg

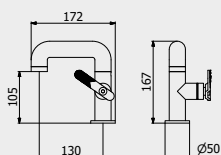

PORTATE | WATER FLOW | DÉBIT D'EAU

1 BAR	2 BAR	3 BAR
3 l/m	4,4 l/m	4,5 l/m

ARTICLE | ARTICOLO | ARTICLE

B1202



Tall monohole washbasin mixer complete with drain

Miscelatore lavabo monoforo alto completo di scarico automatico

Mitigeur lavabo Haut complet avec bonde automatique

CODE / COEFFICIENT | CODICE /
COEFFICIENTE | CODE / COEFFICIENT

● CC	B1202CC	12,6
● SS	B1202SS	15,8
● ON	B1202ON	12,6
● NP	B1202NP	15,1
● CF	B1202CF	18,9
● CS	B1202CS	20,2
● II	B1202II	18,9
● IS	B1202IS	20,2
● RS	B1202RS	18,9
● SR	B1202SR	20,2
● OO	B1202OO	18,9
● OS	B1202OS	20,2

.6 LEVA ROSSA | RED
LEVER | LEVIER ROUGE + 0,1

PACKAGING

L: 360 mm
D: 220 mm
H: 150 mm

3,1 kg

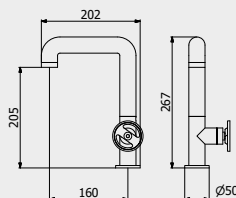

PORTATE | WATER FLOW | DÉBIT D'EAU

1 BAR	2 BAR	3 BAR
3 l/m	4,4 l/m	4,5 l/m

ARTICLE | ARTICOLO | ARTICLE

B2202



Tall monohole washbasin mixer complete with drain

Miscelatore lavabo monoforo alto completo di scarico automatico

Mitigeur lavabo Haut complet avec bonde automatique

CODE / COEFFICIENT | CODICE /
COEFFICIENTE | CODE / COEFFICIENT

● CC	B2202CC	12,6
● SS	B2202SS	15,8
● ON	B2202ON	12,6
● NP	B2202NP	15,1
● CF	B2202CF	18,9
● CS	B2202CS	20,2
● II	B2202II	18,9
● IS	B2202IS	20,2
● RS	B2202RS	18,9
● SR	B2202SR	20,2
● OO	B2202OO	18,9
● OS	B2202OS	20,2

.6 LEVA ROSSA | RED
LEVER | LEVIER ROUGE + 0,1

PACKAGING

L: 360 mm
D: 220 mm
H: 150 mm

3,1 kg

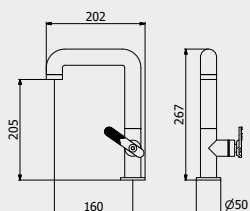

PORTATE | WATER FLOW | DÉBIT D'EAU

1 BAR	2 BAR	3 BAR
3 l/m	4,4 l/m	4,5 l/m



ARTICLE | ARTICOLO | ARTICLE

B1205



Monohole washbasin with two handles complete with drain
Lavabo monoforo con due leve completo di scarico automatico
Mélangeur lavabo monotrou complet avec bonde automatique

CODE / COEFFICIENT	CODICE / COEFFICIENTE	
CC	B1205CC	13,9
SS	B1205SS	17,4
ON	B1205ON	13,9
NP	B1205NP	16,7
CF	B1205CF	20,9
CS	B1205CS	22,2
II	B1205II	20,9
IS	B1205IS	22,2
RS	B1205RS	20,9
SR	B1205SR	22,2
OO	B1205OO	20,9
OS	B1205OS	22,2
6	LEVA ROSSA RED LEVER LEVIER ROUGE	+ 0,2

PACKAGING

L: 353 mm
D: 225 mm
H: 226 mm
3,4 kg

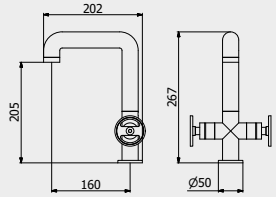

PORTATE | WATER FLOW | DÉBIT D'EAU

1 BAR	2 BAR	3 BAR
3,3 l/m	4,4 l/m	4,5 l/m

ARTICLE | ARTICOLO | ARTICLE

B2205



Monohole washbasin with two handles complete with drain
Lavabo monoforo con due leve completo di scarico automatico
Mélangeur lavabo monotrou complet avec bonde automatique

CODE / COEFFICIENT	CODICE / COEFFICIENTE	
CC	B2205CC	13,9
SS	B2205SS	17,4
ON	B2205ON	13,9
NP	B2205NP	16,7
CF	B2205CF	20,9
CS	B2205CS	22,2
II	B2205II	20,9
IS	B2205IS	22,2
RS	B2205RS	20,9
SR	B2205SR	22,2
OO	B2205OO	20,9
OS	B2205OS	22,2
6	LEVA ROSSA RED LEVER LEVIER ROUGE	+ 0,2

PACKAGING

L: 353 mm
D: 225 mm
H: 226 mm
3,4 kg

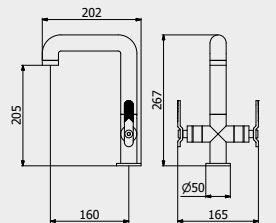

PORTATE | WATER FLOW | DÉBIT D'EAU

1 BAR	2 BAR	3 BAR
3,3 l/m	4,4 l/m	4,5 l/m

ARTICLE | ARTICOLO | ARTICLE

B2206



Wall mounted washbasin mixer complete with drain
Miscelatore lavabo due fori a parete completo di scarico automatico
Mitigeur lavabo Mural complet avec bonde automatique

CODE / COEFFICIENT	CODICE / COEFFICIENTE	
CC	EB2206CC	12,6
SS	EB2206SS	15,8
ON	EB2206ON	12,6
NP	EB2206NP	15,1
CF	EB2206CF	18,9
CS	EB2206CS	20,2
II	EB2206II	18,9
IS	EB2206IS	20,2
RS	EB2206RS	18,9
SR	EB2206SR	20,2
OO	EB2206OO	18,9
OS	EB2206OS	20,2
6	LEVA ROSSA RED LEVER LEVIER ROUGE	+ 0,1

PACKAGING

L: 265 mm
D: 260 mm
H: 70 mm
1,7 kg

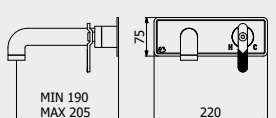

PORTATE | WATER FLOW | DÉBIT D'EAU

1 BAR	2 BAR	3 BAR
3,3 l/m	4,4 l/m	4,5 l/m

Built-in body to be purchased separately
Corpo incasso da acquistare separatamente
Corps intégré à acheter séparément



CODICE | CODE | CODE

INC206XXXN_19

COEFFICIENT | COEFFICIENTE | COEFFICIENT

2,9

ARTICLE | ARTICOLO | ARTICLE

B1209



Mono hole wall mounted washbasin mixer

Miscelatore lavabo a parete monoforo completo di scarico automatico
Mitigeur lavabo mural monotrou complet avec bonde automatique

CODE / COEFFICIENT	CODICE / COEFFICIENTE	
CC	B1209CC	14,1
SS	B1209SS	17,6
ON	B1209ON	14,1
NP	B1209NP	16,9
CF	B1209CF	21,2
CS	B1209CS	22,6
II	B1209II	21,2
IS	B1209IS	22,6
RS	B1209RS	21,2
SR	B1209SR	22,6
OO	B1209OO	21,2
OS	B1209OS	22,6
_6	LEVA ROSSA RED LEVER LEVIER ROUGE	+ 0,1

PACKAGING

L: 425 mm
D: 188 mm
H: 98 mm

2,1 kg

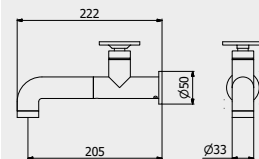

PORTATE | WATER FLOW | DÉBIT D'EAU

1 BAR	2 BAR	3 BAR
3,3 l/m	4,4 l/m	4,5 l/m

ARTICLE | ARTICOLO | ARTICLE

B2209



Mono hole wall mounted washbasin mixer

Miscelatore lavabo a parete monoforo completo di scarico automatico
Mitigeur lavabo mural monotrou complet avec bonde automatique

CODE / COEFFICIENT	CODICE / COEFFICIENTE	
CC	B2209CC	14,1
SS	B2209SS	17,6
ON	B2209ON	14,1
NP	B2209NP	16,9
CF	B2209CF	21,2
CS	B2209CS	22,6
II	B2209II	21,2
IS	B2209IS	22,6
RS	B2209RS	21,2
SR	B2209SR	22,6
OO	B2209OO	21,2
OS	B2209OS	22,6
_6	LEVA ROSSA RED LEVER LEVIER ROUGE	+ 0,1

PACKAGING

L: 425 mm
D: 188 mm
H: 98 mm

2,1 kg

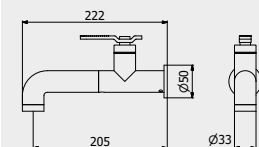

PORTATE | WATER FLOW | DÉBIT D'EAU

1 BAR	2 BAR	3 BAR
3,3 l/m	4,4 l/m	4,5 l/m

ARTICLE | ARTICOLO | ARTICLE

B2210

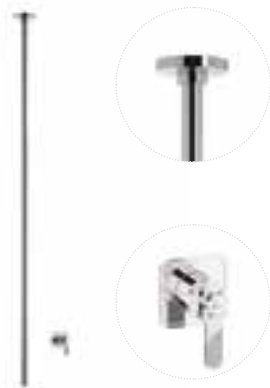

Ceiling spout with wall mounted mixer

Bocca da soffitto con comando remoto ad incasso
Mitigeur lavabo mural avec bec plafond complet avec bonde automatique

CODE / COEFFICIENT	CODICE / COEFFICIENTE	
CC	EB2210CC	30,9
SS	EB2210SS	38,7
ON	EB2210ON	30,9
NP	EB2210NP	37,1
CF	EB2210CF	46,4
CS	EB2210CS	49,5
II	EB2210II	46,4
IS	EB2210IS	49,5
RS	EB2210RS	46,4
SR	EB2210SR	49,5
OO	EB2210OO	46,4
OS	EB2210OS	49,5
_6	LEVA ROSSA RED LEVER LEVIER ROUGE	+ 0,1

PACKAGING

L: 150 mm
D: 190 mm
H: 98 mm

L: 1700 mm
Ø: 70 mm

4,5 kg

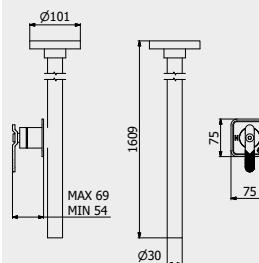

PORTATE | WATER FLOW | DÉBIT D'EAU

1 BAR	2 BAR	3 BAR
4,3 l/m	5,2 l/m	6,9 l/m

Built-in body to be purchased separately

Corpo incasso da acquistare separatamente

Corps intégré à acheter séparément



CODICE | CODE | CODE

INC300XXXN_19

COEFFICIENT | COEFFICIENTE | COEFFICIENT

1,8

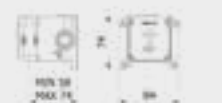

ARTICLE | ARTICOLO | ARTICLE

B1306



Wall mounted widespread lavatory faucet
 Rubinetto lavabo da incasso
 Robinet de lavabo mural

CODE / COEFFICIENT	CODICE / COEFFICIENTE	
CC	B1306CC	13,6
SS	B1306SS	17,0
ON	B1306ON	13,6
NP	B1306NP	16,3
CF	B1306CF	20,4
CS	B1306CS	21,8
II	B1306II	20,4
IS	B1306IS	21,8
RS	B1306RS	20,4
SR	B1306SR	21,8
OO	B1306OO	20,4
OS	B1306OS	21,8
6	LEVA ROSSA RED LEVER LEVIER ROUGE	+ 0,2

PACKAGING

L: 370 mm
 D: 270 mm
 H: 80 mm
 2,4 kg

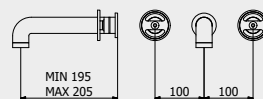

PORTATE	WATER FLOW	DÉBIT D'EAU
1 BAR	2 BAR	3 BAR
3,3 l/m	4,4 l/m	4,5 l/m

ARTICLE | ARTICOLO | ARTICLE

B2306



Wall mounted widespread lavatory faucet
 Rubinetto lavabo da incasso
 Robinet de lavabo mural

CODE / COEFFICIENT	CODICE / COEFFICIENTE	
CC	B2306CC	13,6
SS	B2306SS	17,0
ON	B2306ON	13,6
NP	B2306NP	16,3
CF	B2306CF	20,4
CS	B2306CS	21,8
II	B2306II	20,4
IS	B2306IS	21,8
RS	B2306RS	20,4
SR	B2306SR	21,8
OO	B2306OO	20,4
OS	B2306OS	21,8
6	LEVA ROSSA RED LEVER LEVIER ROUGE	+ 0,2

PACKAGING

L: 370 mm
 D: 270 mm
 H: 80 mm
 2,4 kg

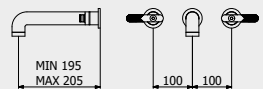

PORTATE	WATER FLOW	DÉBIT D'EAU
1 BAR	2 BAR	3 BAR
3,3 l/m	4,4 l/m	4,5 l/m

ARTICLE | ARTICOLO | ARTICLE

B1390



Three holes washbasin set with tall spout
 Lavabo tre fori bocca alta completo di scarico automatico
 Lavabo trois trous bec haut

CODE / COEFFICIENT	CODICE / COEFFICIENTE	
CC	B1390CC	17,1
SS	B1390SS	21,4
ON	B1390ON	17,1
NP	B1390NP	20,5
CF	B1390CF	25,7
CS	B1390CS	27,4
II	B1390II	25,7
IS	B1390IS	27,4
RS	B1390RS	25,7
SR	B1390SR	27,4
OO	B1390OO	25,7
OS	B1390OS	27,4
6	LEVA ROSSA RED LEVER LEVIER ROUGE	+ 0,2

PACKAGING

L: 455 mm
 D: 310 mm
 H: 75 mm
 2,2 kg

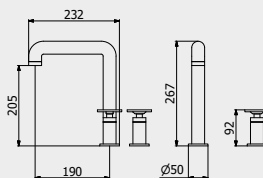

PORTATE	WATER FLOW	DÉBIT D'EAU
1 BAR	2 BAR	3 BAR
3,3 l/m	4,4 l/m	4,5 l/m

ARTICLE | ARTICOLO | ARTICLE

B2390



Three holes washbasin set with tall spout
 Lavabo tre fori bocca alta completo di scarico automatico
 Lavabo trois trous bec haut

CODE / COEFFICIENT	CODICE / COEFFICIENTE	
CC	B2390CC	17,1
SS	B2390SS	21,4
ON	B2390ON	17,1
NP	B2390NP	20,5
CF	B2390CF	25,7
CS	B2390CS	27,4
II	B2390II	25,7
IS	B2390IS	27,4
RS	B2390RS	25,7
SR	B2390SR	27,4
OO	B2390OO	25,7
OS	B2390OS	27,4
6	LEVA ROSSA RED LEVER LEVIER ROUGE	+ 0,2

PACKAGING

L: 455 mm
 D: 310 mm
 H: 75 mm
 2,2 kg

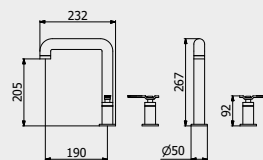

PORTATE	WATER FLOW	DÉBIT D'EAU
1 BAR	2 BAR	3 BAR
3,3 l/m	4,4 l/m	4,5 l/m

ARTICLE | ARTICOLO | ARTICLE

B1392



Three holes washbasin set with low spout

Lavabo tre fori a bocca bassa completo di scarico automatico

Lavabo trois trous bec bas

CODE / COEFFICIENT | CODICE /
COEFFICIENTE | CODE / COEFFICIENT

● CC	B1392CC	15,6
● SS	B1392SS	19,5
● ON	B1392ON	15,6
● NP	B1392NP	18,7
● CF	B1392CF	23,4
● CS	B1392CS	25,0
● II	B1392II	23,4
● IS	B1392IS	25,0
● RS	B1392RS	23,4
● SR	B1392SR	25,0
● OO	B1392OO	23,4
● OS	B1392OS	25,0

PACKAGING

 L: 455 mm
D: 310 mm
H: 75 mm

4,4 kg

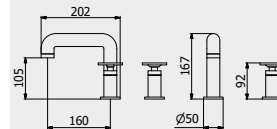

PORTATE | WATER FLOW | DÉBIT D'EAU

1 BAR	2 BAR	3 BAR
3,3 l/m	4,4 l/m	4,5 l/m

ARTICLE | ARTICOLO | ARTICLE

B2392



Three holes washbasin set with low spout

Lavabo tre fori a bocca bassa completo di scarico automatico

Lavabo trois trous bec bas

CODE / COEFFICIENT | CODICE /
COEFFICIENTE | CODE / COEFFICIENT

● CC	B2392CC	15,6
● SS	B2392SS	19,5
● ON	B2392ON	15,6
● NP	B2392NP	18,7
● CF	B2392CF	23,4
● CS	B2392CS	25,0
● II	B2392II	23,4
● IS	B2392IS	25,0
● RS	B2392RS	23,4
● SR	B2392SR	25,0
● OO	B2392OO	23,4
● OS	B2392OS	25,0

PACKAGING

 L: 455 mm
D: 310 mm
H: 75 mm

4,4 kg

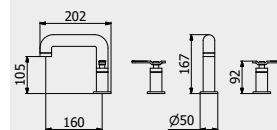

PORTATE | WATER FLOW | DÉBIT D'EAU

1 BAR	2 BAR	3 BAR
3,3 l/m	4,4 l/m	4,5 l/m

ARTICLE | ARTICOLO | ARTICLE

B1220



Monohole bidet mixer complete with drain

Miscelatore bidet monoforo completo di scarico automatico

Mitigeur bidet complet avec bonde automatique

CODE / COEFFICIENT | CODICE /
COEFFICIENTE | CODE / COEFFICIENT

● CC	B1220CC	11,1
● SS	B1220SS	13,9
● ON	B1220ON	11,1
● NP	B1220NP	13,3
● CF	B1220CF	16,7
● CS	B1220CS	17,8
● II	B1220II	16,7
● IS	B1220IS	17,8
● RS	B1220RS	16,7
● SR	B1220SR	17,8
● OO	B1220OO	16,7
● OS	B1220OS	17,8

PACKAGING

 L: 240 mm
D: 215 mm
H: 110 mm

2,2 kg

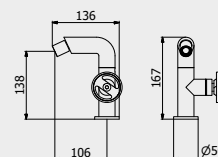

PORTATE | WATER FLOW | DÉBIT D'EAU

1 BAR	2 BAR	3 BAR
5 l/m	7 l/m	8,6 l/m

ARTICLE | ARTICOLO | ARTICLE

B2220



Monohole bidet mixer complete with drain

Miscelatore bidet monoforo completo di scarico automatico

Mitigeur bidet complet avec bonde automatique

CODE / COEFFICIENT | CODICE /
COEFFICIENTE | CODE / COEFFICIENT

● CC	B2220CC	11,1
● SS	B2220SS	13,9
● ON	B2220ON	11,1
● NP	B2220NP	13,3
● CF	B2220CF	16,7
● CS	B2220CS	17,8
● II	B2220II	16,7
● IS	B2220IS	17,8
● RS	B2220RS	16,7
● SR	B2220SR	17,8
● OO	B2220OO	16,7
● OS	B2220OS	17,8

PACKAGING

 L: 240 mm
D: 215 mm
H: 110 mm

2,2 kg

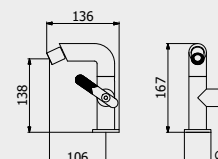

PORTATE | WATER FLOW | DÉBIT D'EAU

1 BAR	2 BAR	3 BAR
5 l/m	7 l/m	8,6 l/m



ARTICLE | ARTICOLO | ARTICLE

B2310

Exposed parts for manual wall mixer with two ways diverter
 Miscelatore doccia a parete con deviatore due vie
 Mitigeur douche mural deux voies avec inverseur

CODE / COEFFICIENT | CODICE /
 COEFFICIENTE | CODE / COEFFICIENT

CC	EB2310CC	8,8
SS	EB2310SS	11,0
ON	EB2310ON	8,8
NP	EB2310NP	10,6
CF	EB2310CF	13,2
CS	EB2310CS	14,1
II	EB2310II	13,2
IS	EB2310IS	14,1
RS	EB2310RS	13,2
SR	EB2310SR	14,1
OO	EB2310OO	13,2
OS	EB2310OS	14,1

PACKAGING

L: 150 mm
 D: 190 mm
 H: 98 mm

2,1 kg

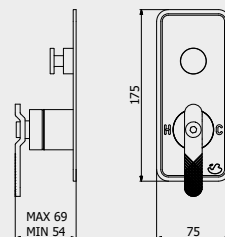

PORTATE | WATER FLOW | DÉBIT D'EAU

1 BAR	2 BAR	3 BAR
9,2 l/m	12,8 l/m	16 l/m

Built-in body to be purchased separately

Corpo incasso da acquistare separatamente

Corps intégré à acheter séparément



CODICE | CODE | CODE

INC310XXXN_19

COEFFICIENT | COEFFICIENTE | COEFFICIENT

3,3



ARTICLE | ARTICOLO | ARTICLE

B2312

Exposed parts for manual wall mixer with three ways diverter
 Set di parti esterne per miscelatore a parete a tre vie
 Mitigeur douche mural trois voies avec inverseur

CODE / COEFFICIENT | CODICE /
 COEFFICIENTE | CODE / COEFFICIENT

CC	EB2312CC	10,2
SS	EB2312SS	12,7
ON	EB2312ON	10,2
NP	EB2312NP	12,2
CF	EB2312CF	15,3
CS	EB2312CS	16,3
II	EB2312II	15,3
IS	EB2312IS	16,3
RS	EB2312RS	15,3
SR	EB2312SR	16,3
OO	EB2312OO	15,3
OS	EB2312OS	16,3

PACKAGING

L: 150 mm
 D: 190 mm
 H: 98 mm

2,2 kg

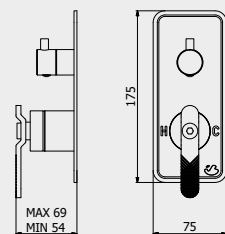

PORTATE | WATER FLOW | DÉBIT D'EAU

1 BAR	2 BAR	3 BAR
8,3 l/m	11,7 l/m	14,3 l/m

Built-in body to be purchased separately

Corpo incasso da acquistare separatamente

Corps intégré à acheter séparément



CODICE | CODE | CODE

INC312XXXN_19

COEFFICIENT | COEFFICIENTE | COEFFICIENT

3,3

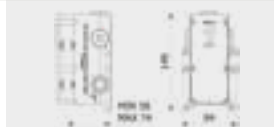

ARTICLE | ARTICOLO | ARTICLE

B2313

Exposed parts for manual wall mixer with 2 ways with shower kit
 Set di parti esterne per miscelatore a parete a due vie completo di kit doccia
 Partie extérieure pour mitigeur encastré à deux voies avec douchette

CODE / COEFFICIENT | CODICE /
 COEFFICIENTE | CODE / COEFFICIENT

CC	EB2313CC	14,4
SS	EB2313SS	18,0
ON	EB2313ON	14,4
NP	EB2313NP	17,3
CF	EB2313CF	21,6
CS	EB2313CS	23,0
II	EB2313II	21,6
IS	EB2313IS	23,0
RS	EB2313RS	21,6
SR	EB2313SR	23,0
OO	EB2313OO	21,6
OS	EB2313OS	23,0

PACKAGING

L: 370 mm
 D: 270 mm
 H: 80 mm

2,8 kg

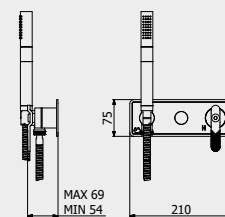

PORTATE | WATER FLOW | DÉBIT D'EAU

1 BAR	2 BAR	3 BAR
10 l/m	14,1 l/m	17,2 l/m

Built-in body to be purchased separately

Corpo incasso da acquistare separatamente

Corps intégré à acheter séparément



CODICE | CODE | CODE

INC313XXXN_19

COEFFICIENT | COEFFICIENTE | COEFFICIENT

3,6



ARTICLE | ARTICOLO | ARTICLE

B2314



Exposed parts for manual wall mixer with 3 ways with shower kit
Set di parti esterne per miscelatore a parete a tre vie completo di kit doccia
Partie extérieure pour mitigeur encastré à trois voies avec douchette

CODE / COEFFICIENT | CODICE /
COEFFICIENTE | CODE / COEFFICIENT

CC	EB2314CC	15,8
SS	EB2314SS	19,8
ON	EB2314ON	15,8
NP	EB2314NP	19,0
CF	EB2314CF	23,7
CS	EB2314CS	25,3
II	EB2314II	23,7
IS	EB2314IS	25,3
RS	EB2314RS	23,7
SR	EB2314SR	25,3
OO	EB2314OO	23,7
OS	EB2314OS	25,3

_6 LEVA ROSSA | RED
LEVER | LEVIER ROUGE + 0,1

PACKAGING

L: 370 mm
D: 270 mm
H: 80 mm

2,8 kg

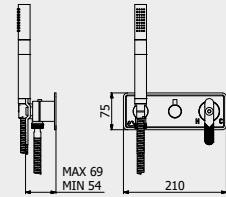

PORTATE | WATER FLOW | DÉBIT D'EAU

1 BAR	2 BAR	3 BAR
8,3 l/m	11,7 l/m	14,3 l/m

Built-in body to be purchased
separately

Corpo incasso da acquistare
separatamente

Corps intégré à acheter
séparément



CODICE | CODE | CODE

INC314XXXN_19

COEFFICIENTE | COEFFICIENTE | COEFFICIENT

3,7

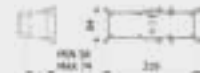

ARTICLE | ARTICOLO | ARTICLE

B1400



Two holes wall mounted shower

Coppia di rubinetti a parete per doccia una via
Mélangeur deux trous douche

CODE / COEFFICIENT | CODICE /
COEFFICIENTE | CODE / COEFFICIENT

CC	B1400CC	6,8
SS	B1400SS	8,5
ON	B1400ON	6,8
NP	B1400NP	8,2
CF	B1400CF	10,2
CS	B1400CS	10,9
II	B1400II	10,2
IS	B1400IS	10,9
RS	B1400RS	10,2
SR	B1400SR	10,9
OO	B1400OO	10,2
OS	B1400OS	10,9

_6 LEVA ROSSA | RED
LEVER | LEVIER ROUGE + 0,2

PACKAGING

L: 340 mm
D: 180 mm
H: 70 mm

2,3 kg

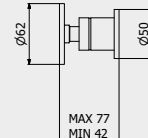

PORTATE | WATER FLOW | DÉBIT D'EAU

1 BAR	2 BAR	3 BAR
28 l/m	40 l/m	49,3 l/m

ARTICLE | ARTICOLO | ARTICLE

B2400



Two holes wall mounted shower

Coppia di rubinetti a parete per doccia una via
Mélangeur deux trous douche

CODE / COEFFICIENT | CODICE /
COEFFICIENTE | CODE / COEFFICIENT

CC	B2400CC	6,8
SS	B2400SS	8,5
ON	B2400ON	6,8
NP	B2400NP	8,2
CF	B2400CF	10,2
CS	B2400CS	10,9
II	B2400II	10,2
IS	B2400IS	10,9
RS	B2400RS	10,2
SR	B2400SR	10,9
OO	B2400OO	10,2
OS	B2400OS	10,9

_6 LEVA ROSSA | RED
LEVER | LEVIER ROUGE + 0,2

PACKAGING

L: 340 mm
D: 180 mm
H: 70 mm

2,3 kg

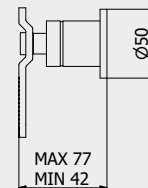

PORTATE | WATER FLOW | DÉBIT D'EAU

1 BAR	2 BAR	3 BAR
28 l/m	40 l/m	49,3 l/m

ARTICLE | ARTICOLO | ARTICLE

B1410



Three holes wall mounted shower with two ways diverter
Tre rubinetti a parete per doccia con deviatore a due vie
Melangeur trois trous douche avec inverseur deux voies

CODE / COEFFICIENT | CODICE /
COEFFICIENTE | CODE / COEFFICIENT

CC	B1410CC	11,7
SS	B1410SS	14,6
ON	B1410ON	11,7
NP	B1410NP	14,0
CF	B1410CF	17,6
CS	B1410CS	18,7
II	B1410II	17,6
IS	B1410IS	18,7
RS	B1410RS	17,6
SR	B1410SR	18,7
OO	B1410OO	17,6
OS	B1410OS	18,7

-6 LEVA ROSSA | RED
LEVER | LEVIER ROUGE + 0,3

PACKAGING

L: 240 mm
D: 215 mm
H: 110 mm

2,8 kg

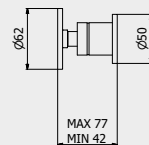

PORTATE | WATER FLOW | DÉBIT D'EAU

	1 BAR	2 BAR	3 BAR
Uscita principale / Main outlet / Sortie principale	16 l/m	22,4 l/m	27,5 l/m
Doccetta / Handshower / Douchette	14,7 l/m	20,6 l/m	25,3 l/m

ARTICLE | ARTICOLO | ARTICLE

B2410



Three holes wall mounted shower with two ways diverter
Tre rubinetti a parete per doccia con deviatore a due vie
Melangeur trois trous douche avec inverseur deux voies

CODE / COEFFICIENT | CODICE /
COEFFICIENTE | CODE / COEFFICIENT

CC	B2410CC	11,7
SS	B2410SS	14,6
ON	B2410ON	11,7
NP	B2410NP	14,0
CF	B2410CF	17,6
CS	B2410CS	18,7
II	B2410II	17,6
IS	B2410IS	18,7
RS	B2410RS	17,6
SR	B2410SR	18,7
OO	B2410OO	17,6
OS	B2410OS	18,7

-6 LEVA ROSSA | RED
LEVER | LEVIER ROUGE + 0,3

PACKAGING

L: 240 mm
D: 215 mm
H: 110 mm

2,8 kg

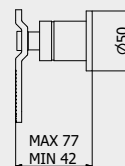

PORTATE | WATER FLOW | DÉBIT D'EAU

	1 BAR	2 BAR	3 BAR
Acqua miscelata / Mixed water / Eau mélangée	16 l/m	22,4 l/m	27,5 l/m
Doccetta / Handshower / Douchette	14,7 l/m	20,6 l/m	25,3 l/m

ARTICLE | ARTICOLO | ARTICLE

B1800



Bold thermostatic shower column with shower kit
Colonna doccia Bold termostatica con kit doccia
Bold Colonne de douche thermostatique avec kit douche

CODE / COEFFICIENT | CODICE /
COEFFICIENTE | CODE / COEFFICIENT

CC	B2800CC	53,7
SS	B2800SS	67,1
ON	B2800ON	53,7
NP	B2800NP	64,4
CF	B2800CF	80,6
CS	B2800CS	85,9
II	B2800II	80,6
IS	B2800IS	85,9
RS	B2800RS	80,6
SR	B2800SR	85,9
OO	B2800OO	80,6
OS	B2800OS	85,9

-6 LEVA ROSSA | RED
LEVER | LEVIER ROUGE + 0,2

PACKAGING

L: 800 mm
D: 500 mm
H: 180 mm

12,1 kg

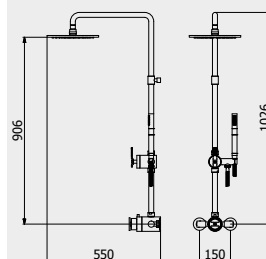

PORTATE | WATER FLOW | DÉBIT D'EAU

	1 BAR	2 BAR	3 BAR
Acqua miscelata / Mixed water / Eau mélangée	10,7 l/m	15 l/m	18,5 l/m
Doccetta / Handshower / Douchette	6,7 l/m	9,6 l/m	11,9 l/m



ARTICLE | ARTICOLO | ARTICLE

B1396



Five holes deck mounted bath filler with shower kit

Bordo vasca cinque fori con deviatore e kit doccia

Bain/douche cinq trous avec inverseur et Kit Douche

CODE / COEFFICIENT | CODICE /
COEFFICIENTE | CODE / COEFFICIENT

CC	B1396CC	25,5
SS	B1396SS	31,9
ON	B1396ON	25,5
NP	B1396NP	30,6
CF	B1396CF	38,3
CS	B1396CS	40,8
II	B1396II	38,3
IS	B1396IS	40,8
RS	B1396RS	38,3
SR	B1396SR	40,8
OO	B1396OO	38,3
OS	B1396OS	40,8

PACKAGING

L: 675 mm
D: 320 mm
H: 80 mm

5,9 kg

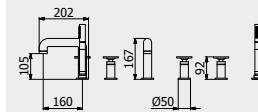

_6 LEVA ROSSA | RED
LEVER | LEVIER ROUGE + 0,3

PORTATE | WATER FLOW | DÉBIT D'EAU

	1 BAR	2 BAR	3 BAR
Acqua miscelata / Mixed water / Eau mélangée	13,6 l/m	19,1 l/m	3,6 l/m
Solo calda / Only hot / Seulement chaud	9,1 l/m	12,9 l/m	15,9 l/m
Doccetta / Handshower / Douchette	6,8 l/m	10 l/m	12,5 l/m

ARTICLE | ARTICOLO | ARTICLE

B2396



Five holes deck mounted bath filler with shower kit

Bordo vasca cinque fori con deviatore e kit doccia

Bain/douche cinq trous avec inverseur et Kit Douche

CODE / COEFFICIENT | CODICE /
COEFFICIENTE | CODE / COEFFICIENT

CC	B2396CC	25,5
SS	B2396SS	31,9
ON	B2396ON	25,5
NP	B2396NP	30,6
CF	B2396CF	38,3
CS	B2396CS	40,8
II	B2396II	38,3
IS	B2396IS	40,8
RS	B2396RS	38,3
SR	B2396SR	40,8
OO	B2396OO	38,3
OS	B2396OS	40,8

PACKAGING

L: 675 mm
D: 320 mm
H: 80 mm

5,9 kg

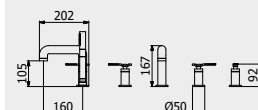

_6 LEVA ROSSA | RED
LEVER | LEVIER ROUGE + 0,3

PORTATE | WATER FLOW | DÉBIT D'EAU

	1 BAR	2 BAR	3 BAR
Acqua miscelata / Mixed water / Eau mélangée	13,6 l/m	19,1 l/m	23,6 l/m
Solo calda / Only hot / Seulement chaud	9,1 l/m	12,9 l/m	15,9 l/m
Doccetta / Handshower / Douchette	6,8 l/m	10 l/m	12,5 l/m

ARTICLE | ARTICOLO | ARTICLE

B1397



4 holes bath filler with overflow outlet connection, diverter and shower kit

Bordo vasca 4 fori per colonna riempimento con deviatore e kit doccia

Bain/douche 4 trous avec inverseur et Kit Douche pour remplissage ETP

CODE / COEFFICIENT | CODICE /
COEFFICIENTE | CODE / COEFFICIENT

CC	B1397CC	18,6
SS	B1397SS	23,3
ON	B1397ON	18,6
NP	B1397NP	22,3
CF	B1397CF	27,9
CS	B1397CS	29,8
II	B1397II	27,9
IS	B1397IS	29,8
RS	B1397RS	27,9
SR	B1397SR	29,8
OO	B1397OO	27,9
OS	B1397OS	29,8

PACKAGING

L: 455 mm
D: 310 mm
H: 75 mm

4,7 kg

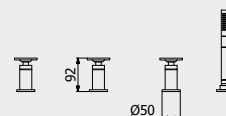

_6 LEVA ROSSA | RED
LEVER | LEVIER ROUGE + 0,3

PORTATE | WATER FLOW | DÉBIT D'EAU

	1 BAR	2 BAR	3 BAR
Acqua miscelata / Mixed water / Eau mélangée	16 l/m	23 l/m	28 l/m
Doccetta / Handshower / Douchette	6,8 l/m	10 l/m	12,5 l/m

ARTICLE | ARTICOLO | ARTICLE

B2397



4 holes bath filler with overflow outlet connection, diverter and shower kit
Bordo vasca 4 fori per colonna riempimento con deviatore e kit doccia
Bain/douche 4 trous avec inverseur et Kit Douche pour remplissage ETP

CODE / COEFFICIENT | CODICE /
COEFFICIENTE | CODE / COEFFICIENT

● CC	B2397CC	18,6
● SS	B2397SS	23,3
● ON	B2397ON	18,6
● NP	B2397NP	22,3
● CF	B2397CF	27,9
● CS	B2397CS	29,8
● II	B2397II	27,9
● IS	B2397IS	29,8
● RS	B2397RS	27,9
● SR	B2397SR	29,8
● OO	B2397OO	27,9
● OS	B2397OS	29,8

PACKAGING

📦 L: 455 mm
D: 310 mm
H: 75 mm

📏 4,7 kg

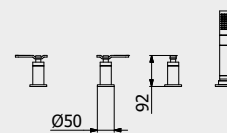

PORTATE | WATER FLOW | DÉBIT D'EAU

	1 BAR	2 BAR	3 BAR
Acqua miscelata / Mixed water / Eau mélangée	16 l/m	23 l/m	28 l/m
Doccetta / Handshower / Douchette	6,8 l/m	10 l/m	12,5 l/m

ARTICLE | ARTICOLO | ARTICLE

B1398



Five holes wall mounted bath filler with shower kit

Bordo vasca a parete cinque fori con deviatore e kit doccia
Bain/douche cinq trous avec inverseur et Kit Douche

CODE / COEFFICIENT | CODICE /
COEFFICIENTE | CODE / COEFFICIENT

● CC	B1398CC	22,1
● SS	B1398SS	27,6
● ON	B1398ON	22,1
● NP	B1398NP	26,5
● CF	B1398CF	33,2
● CS	B1398CS	35,4
● II	B1398II	33,2
● IS	B1398IS	35,4
● RS	B1398RS	33,2
● SR	B1398SR	35,4
● OO	B1398OO	33,2
● OS	B1398OS	35,4

PACKAGING

📦 L: 470 mm
D: 290 mm
H: 160 mm

📏 4,9 kg

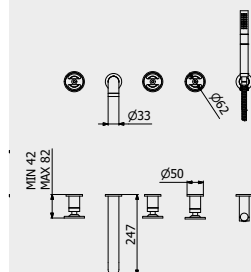

PORTATE | WATER FLOW | DÉBIT D'EAU

	1 BAR	2 BAR	3 BAR
Acqua miscelata / Mixed water / Eau mélangée	12,3 l/m	17,5 l/m	21,8 l/m
Solo calda / Only hot / Seulement chaud	9,2 l/m	12,9 l/m	16 l/m
Doccetta / Handshower / Douchette	8,1 l/m	12,5 l/m	14 l/m

ARTICLE | ARTICOLO | ARTICLE

B2398



Five holes wall mounted bath filler with shower kit

Bordo vasca a parete cinque fori con deviatore e kit doccia
Bain/douche cinq trous avec inverseur et Kit Douche

CODE / COEFFICIENT | CODICE /
COEFFICIENTE | CODE / COEFFICIENT

● CC	B2398CC	22,1
● SS	B2398SS	27,6
● ON	B2398ON	22,1
● NP	B2398NP	26,5
● CF	B2398CF	33,2
● CS	B2398CS	35,4
● II	B2398II	33,2
● IS	B2398IS	35,4
● RS	B2398RS	33,2
● SR	B2398SR	35,4
● OO	B2398OO	33,2
● OS	B2398OS	35,4

PACKAGING

📦 L: 470 mm
D: 290 mm
H: 160 mm

📏 4,9 kg

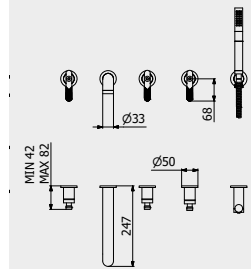

PORTATE | WATER FLOW | DÉBIT D'EAU

	1 BAR	2 BAR	3 BAR
Acqua miscelata / Mixed water / Eau mélangée	12,3 l/m	17,5 l/m	21,8 l/m
Solo calda / Only hot / Seulement chaud	9,2 l/m	12,9 l/m	16 l/m
Doccetta / Handshower / Douchette	8,1 l/m	11,5 l/m	14 l/m



ARTICLE | ARTICOLO | ARTICLE

B1700

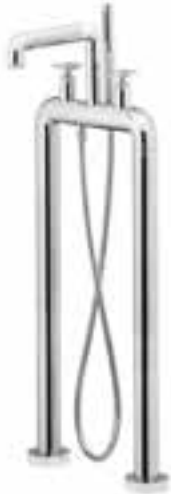

Free-standing two columns bath filler with shower kit
Bordo vasca da terra a doppia colonna con kit doccia
Mélangeur bain/douche complet avec alimentation sol

CODE / COEFFICIENT	CODICE / COEFFICIENTE	
CC	B1700CC	47,1
SS	B1700SS	58,9
ON	B1700ON	47,1
NP	B1700NP	56,5
CF	B1700CF	70,7
CS	B1700CS	75,4
II	B1700II	70,7
IS	B1700IS	75,4
RS	B1700RS	70,7
SR	B1700SR	75,4
OO	B1700OO	70,7
OS	B1700OS	75,4
6	LEVA ROSSA RED LEVER LEVIER ROUGE	+ 0,2

PACKAGING

L: 1020 mm
D: 480 mm
H: 120 mm
12,8 kg

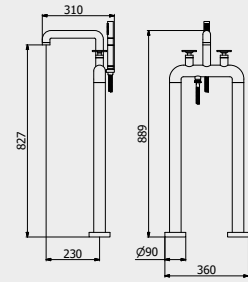

PORTATE | WATER FLOW | DÉBIT D'EAU

	1 BAR	2 BAR	3 BAR
Acqua miscelata / Mixed water / Eau mélangée	24,5 l/m	34,6 l/m	43 l/m
Solo calda / Only hot / Seulement chaud	19,8 l/m	28,4 l/m	34,8 l/m
Doccetta / Handshower / Douchette	7,9 l/m	11,4 l/m	14,2 l/m

ARTICLE | ARTICOLO | ARTICLE

B2700

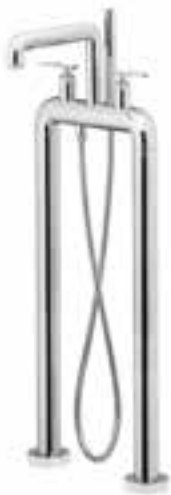

Free-standing two columns bath filler with shower kit
Bordo vasca da terra a doppia colonna con kit doccia
Mélangeur bain/douche complet avec alimentation sol

CODE / COEFFICIENT	CODICE / COEFFICIENTE	
CC	B2700CC	47,1
SS	B2700SS	58,9
ON	B2700ON	47,1
NP	B2700NP	56,5
CF	B2700CF	70,7
CS	B2700CS	75,4
II	B2700II	70,7
IS	B2700IS	75,4
RS	B2700RS	70,7
SR	B2700SR	75,4
OO	B2700OO	70,7
OS	B2700OS	75,4
6	LEVA ROSSA RED LEVER LEVIER ROUGE	+ 0,2

PACKAGING

L: 1020 mm
D: 480 mm
H: 120 mm
12,8 kg

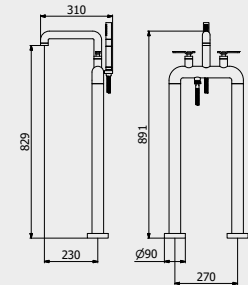

PORTATE | WATER FLOW | DÉBIT D'EAU

	1 BAR	2 BAR	3 BAR
Acqua miscelata / Mixed water / Eau mélangée	24,5 l/m	34,6 l/m	43 l/m
Solo calda / Only hot / Seulement chaud	19,8 l/m	28,4 l/m	34,8 l/m
Doccetta / Handshower / Douchette	7,9 l/m	11,4 l/m	14,2 l/m

ARTICLE | ARTICOLO | ARTICLE

B2022



Duplex BOLD
Duplex BOLD
Duplex BOLD

CODE / COEFFICIENT	CODICE / COEFFICIENTE	
CC	B2022CC	6,3
SS	B2022SS	7,9
ON	B2022ON	6,3
NP	B2022NP	7,9
CF	B2022CF	9,5
CS	B2022CS	10,1
II	B2022II	9,5
IS	B2022IS	10,1
RS	B2022RS	9,5
SR	B2022SR	10,1
OO	B2022OO	9,5
OS	B2022OS	10,1

PACKAGING

L: 340 mm
D: 180 mm
H: 70 mm
1,0 kg

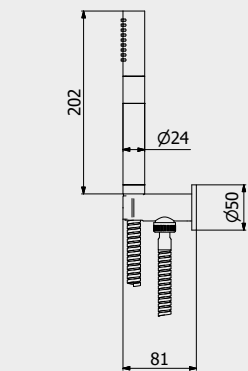

ARTICLE | ARTICOLO | ARTICLE

B2706



Exposed parts for bidet spray complete with mixer

Set di parti esterne per Idroscopino igienico con miscelatore

Partie extérieure pour douchette hygiénique avec mitigeur

CODE / COEFFICIENT | CODICE /
COEFFICIENTE | CODE / COEFFICIENT

CC	EB2706CC	12,5
SS	EB2706SS	15,6
ON	EB2706ON	12,5
NP	EB2706NP	15,0
CF	EB2706CF	18,8
CS	EB2706CS	20,0
II	EB2706II	18,8
IS	EB2706IS	20,0
RS	EB2706RS	18,8
SR	EB2706SR	20,0
OO	EB2706OO	18,8
OS	EB2706OS	20,0

-6 LEVA ROSSA | RED
LEVER | LEVIER ROUGE + 0,1

PACKAGING

L: 370 mm
D: 270 mm
H: 80 mm

2,8 kg

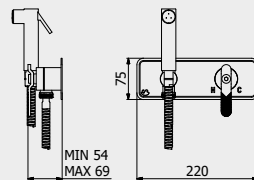

PORTATE | WATER FLOW | DÉBIT D'EAU

1 BAR	2 BAR	3 BAR
2,3 l/m	3,2 l/m	4 l/m

Built-in body to be purchased
separatelyCorpo incasso da acquistare
separatamenteCorps intégré à acheter
séparément

CODICE | CODE | CODE

INC206XXXN_19

COEFFICIENT | COEFFICIENTE | COEFFICIENT

2,9

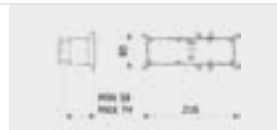

ARTICLE | ARTICOLO | ARTICLE

B1370



Single Lever kitchen mixer

Miscelatore lavello monoforo

Évier de cuisine

CODE / COEFFICIENT | CODICE /
COEFFICIENTE | CODE / COEFFICIENT

CC	B1370CC	14
SS	B1370SS	17,5
ON	B1370ON	14,0
NP	B1370NP	16,8
CF	B1370CF	21,0
CS	B1370CS	22,4
II	B1370II	21,0
IS	B1370IS	22,4
RS	B1370RS	21,0
SR	B1370SR	22,4
OO	B1370OO	21,0
OS	B1370OS	22,4

-6 LEVA ROSSA | RED
LEVER | LEVIER ROUGE + 0,1

PACKAGING

L: 400 mm
D: 250 mm
H: 140 mm

3,5 kg

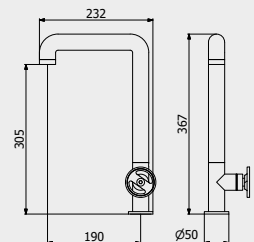

PORTATE | WATER FLOW | DÉBIT D'EAU

1 BAR	2 BAR	3 BAR
3 l/m	4,4 l/m	4,5 l/m

ARTICLE | ARTICOLO | ARTICLE

B2370



Single Lever kitchen mixer

Miscelatore lavello monoforo

Évier de cuisine

CODE / COEFFICIENT | CODICE /
COEFFICIENTE | CODE / COEFFICIENT

CC	B2370CC	14
SS	B2370SS	17,5
ON	B2370ON	14,0
NP	B2370NP	16,8
CF	B2370CF	21,0
CS	B2370CS	22,4
II	B2370II	21,0
IS	B2370IS	22,4
RS	B2370RS	21,0
SR	B2370SR	22,4
OO	B2370OO	21,0
OS	B2370OS	22,4

-6 LEVA ROSSA | RED
LEVER | LEVIER ROUGE + 0,1

PACKAGING

L: 400 mm
D: 250 mm
H: 140 mm

3,5 kg

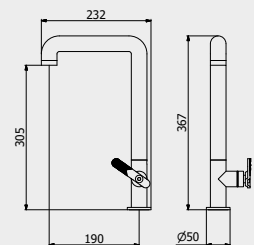

PORTATE | WATER FLOW | DÉBIT D'EAU

1 BAR	2 BAR	3 BAR
3 l/m	4,4 l/m	4,5 l/m



OFFICINA / ACCESSORIES COLLECTION



ARTICLE | ARTICOLO | ARTICLE

OF006



PACKAGING

L: 330 mm
D: 90 mm
H: 40 mm

0,15 kg

Towel holder
Porta salvietta
Porte-serviette

CODE / COEFFICIENT | CODICE /
COEFFICIENTE | CODE / COEFFICIENT

CC	OF006CC	2,4
SS	OF006SS	3,0
ON	OF006ON	2,4
BO	OF006BO	2,9
NP	OF006NP	2,9
CF	OF006CF	3,6
CS	OF006CS	3,8
II	OF006II	3,6
IS	OF006IS	3,8
RS	OF006RS	3,6
SR	OF006SR	3,8
OO	OF006OO	3,6
OS	OF006OS	3,8

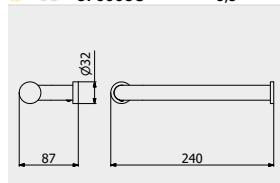

ARTICLE | ARTICOLO | ARTICLE

OF011



PACKAGING

L: 410 mm
D: 195 mm
H: 100 mm

0,3 kg

Toilet paper holder
Porta rotolo
Porte rouleaux de toilette

CODE / COEFFICIENT | CODICE /
COEFFICIENTE | CODE / COEFFICIENT

CC	OF011CC	2,1
SS	OF011SS	2,6
ON	OF011ON	2,1
BO	OF011BO	2,6
NP	OF011NP	2,6
CF	OF011CF	3,2
CS	OF011CS	3,4
II	OF011II	3,2
IS	OF011IS	3,4
RS	OF011RS	3,2
SR	OF011SR	3,4
OO	OF011OO	3,2
OS	OF011OS	3,4

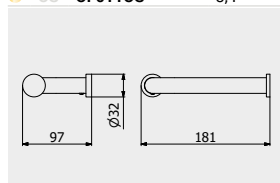

ARTICLE | ARTICOLO | ARTICLE

OF012



PACKAGING

L: 410 mm
D: 195 mm
H: 100 mm

0,3 kg

Toilet brush holder
Porta scopino da terra
Porte balayette au sol

CODE / COEFFICIENT | CODICE /
COEFFICIENTE | CODE / COEFFICIENT

CC	OF012CC	6,9
SS	OF012SS	8,6
ON	OF012ON	6,9
BO	OF012BO	8,6
NP	OF012NP	8,6
CF	OF012CF	10,4
CS	OF012CS	11,0
II	OF012II	10,4
IS	OF012IS	11,0
RS	OF012RS	10,4
SR	OF012SR	11,0
OO	OF012OO	10,4
OS	OF012OS	11,0

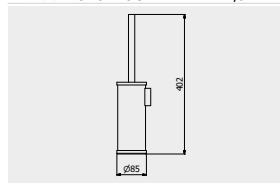

ARTICLE | ARTICOLO | ARTICLE

OF008



PACKAGING

L: 60 mm
D: 60 mm
H: 60 mm

0,08 kg

Robe Hook
Appendino a parete
Cintre

CODE / COEFFICIENT | CODICE /
COEFFICIENTE | CODE / COEFFICIENT

CC	OF008CC	1,0
SS	OF008SS	1,3
ON	OF008ON	1,0
BO	OF006BO	1,3
NP	OF008NP	1,3
CF	OF008CF	1,5
CS	OF008CS	1,6
II	OF008II	1,5
IS	OF008IS	1,6
RS	OF008RS	1,5
SR	OF008SR	1,6
OO	OF008OO	1,5
OS	OF008OS	1,6

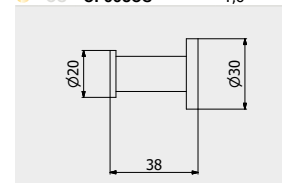

ARTICLE | ARTICOLO | ARTICLE

OF014



PACKAGING

L: 500 mm
D: 100 mm
H: 45 mm

0,4 kg

Towel holder
Porta salvietta
Porte-serviette

CODE / COEFFICIENT | CODICE /
COEFFICIENTE | CODE / COEFFICIENT

CC	OF014CC	3,7
SS	OF014SS	4,6
ON	OF014ON	3,7
BO	OF014BO	4,6
NP	OF014NP	4,6
CF	OF014CF	5,6
CS	OF014CS	5,9
II	OF014II	5,6
IS	OF014IS	5,9
RS	OF014RS	5,6
SR	OF014SR	5,9
OO	OF014OO	5,6
OS	OF014OS	5,9

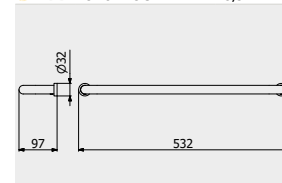

ARTICLE | ARTICOLO | ARTICLE

OF002



PACKAGING

L: 170 mm
D: 60 mm
H: 80 mm

0,6 kg

Soap dispenser holder
Porta dispenser sapone liquido
Porte distributeur de savon

CODE / COEFFICIENT | CODICE /
COEFFICIENTE | CODE / COEFFICIENT

CC	OF002CC	3,7
SS	OF002SS	4,6
ON	OF002ON	3,7
BO	OF002BO	4,6
NP	OF002NP	4,6
CF	OF002CF	5,6
CS	OF002CS	5,9
II	OF002II	5,6
IS	OF002IS	5,9
RS	OF002RS	5,6
SR	OF002SR	5,9
OO	OF002OO	5,6
OS	OF002OS	5,9

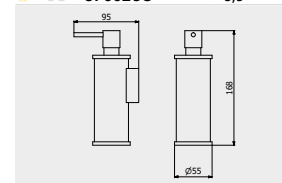



MARMO / MARMO L

Never can be two identical Marmo.

Non esisteranno mai due Marmo identici
Jamais il n'y aura deux Marmo identiques

A synthesis between eternity and current fashion, tradition and fantasy. The MARMO collection focuses on the quality of the raw material, carefully selected and processed in order to obtain a thin and resistant case, perfect in its cylindrical shape and original in its uniqueness.

The hand-made stone conceals inside an innovative compact mixer, which provides the highest technological performances in the slightest space.

Una sintesi di eternità e attualità, di tradizione e fantasia. La serie MARMO è incentrata sulla qualità della materia prima, attentamente selezionata e lavorata al fine di ottenere un involucro sottile e resistente, perfetto nella sua forma cilindrica e originale nella sua irripetibilità.

Lavorata a mano, la pietra nasconde al suo interno un miscelatore compatto innovativo, che in un minimo spazio fornisce le più alte performance tecnologiche.

Une synthèse entre éternité et modernité, tradition et fantaisie. La collection MARMO est axée sur la qualité de la matière première, soigneusement sélectionnée et traitée afin d'obtenir une enveloppe fin et résistante, parfaite dans sa forme cylindrique et originale dans sa unicité.

Ouvragée à la main, la pierre cache un mixeur compact innovant qui offre les meilleures performances technologiques dans le moindre espace.



CRYSTAL CLEAR
WATER



DOUBLE SPOUT



LEAD FREE



ZINC FREE





MARMO is a bathroom collection where the uniqueness of the stone and the unpredictable veins of the marble make every piece of the series unique: there can't be two identical MARMO.

Marmo è una collezione di rubinetti che sfrutta l'unicità della pietra e le sue venature imprevedibili: non esistono due MARMO identici, ogni elemento della collezione è in modo naturale un pezzo unico.

MARMO est la collection pour la salle de bain où l'unicité de la pierre et les veines imprévisibles du marbre font de chaque unité un pièce unique : jamais ne pourrait-il y avoir deux Marmo identiques.





MARMO is the result between the combination of industrial processes and the know-how of the best Italian artisans translated in to simple geometric shapes enriched with the intrinsic aesthetic of the material. The series comprehends different elegant products designed in several finishes; the marble parts are produced in white Carrara and black Marquina while the metal elements are made out of brass in chrome, white, black, gold, brushed nickel and gold rose finishes. This makes MARMO satisfying different needs, styles and tastes.

MARMO nasce dall'unione tra innovazione tecnologica e artigianato tradotta in forme essenziali e geometriche arricchite dall'estetica intrinseca del materiale. MARMO è una linea di prodotti elegante disegnata in diverse finiture; le parti in marmo sono realizzate in bianco Carrara o nero Marquina, mentre gli elementi metallici sono in ottone con finitura cromo, bianco, nero, oro, nickel spazzolato e oro rosa. Questo rende MARMO versatile e adattabile a un ampio numero di ambienti.

MARMO est le résultat d'une combinaison entre la production industrielle et le meilleur savoir-faire artisanal italien, traduit dans des formes géométriques simples, enrichies par la seule esthétique intrinsèque au matériel. La série comprend plusieurs produits élégants, conçus en plusieurs finitions ; les éléments en marbre sont fabriqués en Carrara blanc et Marquina noir, alors que les éléments métalliques sont ornés de finitions en laiton chromé blanc, noir, or, nickel brossé et rose doré. Tout ces éléments permettent à MARMO de satisfaire les besoins, les styles et les goûts les plus variés.







← MM200CC_1
Monohole washbasin mixer
Miscelatore lavabo monoforo
Mitigeur lavabo

→ MR202CC_1
Tall monohole washbasin mixer
Miscelatore lavabo monoforo alto
Mitigeur lavabo Haut

↘ MR306CC_2
Wall mounted widespread lavatory faucet
Rubinetto lavabo da incasso
Robinet de lavabo mural

Marmo





- MR220CC_2
Monohole bidet mixer
Miscelatore bidet monoforo
Mitigeur bidet

- ↙ MR392CC_1
Three holes washbasin set with low spout
Lavabo tre fori a bocca bassa
Lavabo trois trous bec bas

- ↘ MR209CC_2
Mono hole wall mounted washbasin mixer
Miscelatore lavabo a parete monoforo
Mitigeur lavabo mural monotrou

Marmo





← **MR300CC_19**
One way wall shower mixer
Miscelatore doccia a parete una via
Mitigeur douche mural une voie

↙ **MR706CC_19**
Exposed parts for bidet spray complete with mixer
Set di parti esterne per Idroscopino igienico con miscelatore
Partie extérieure pour douchette hygiénique avec mitigeur

→ **MR313CC_20**
Two ways wall shower mixer with shower kit
Miscelatore doccia a parete con deviatore due vie e doccia integrato
Mitigeur douche mural deux voies avec inverseur et douchette encastrée







← MR320CC_1
Wall mounted spout
Bocca d'erogazione a parete
Bec de remplissage mural

→ EUA411CCNMR2
Thermostatic 4 ways
Termostatico 4 vie
Thermostatique 4 voies

↙ MR410CC_2
Three holes wall mounted shower with two
ways diverter
Tre rubinetti a parete per doccia con deviatore
a due vie
Melangeur trois trous douche avec inverseur
deux voies









← MR399CC_2

Free-standing bath filler with shower kit

Bordo vasca da terra con kit doccia

Bain douche complet alimentation au sol

↑ MR396CC_1

Five holes deck mounted bath filler with shower kit

Bordo vasca cinque fori con deviatore e kit doccia

Bain/douche cinq trous avec inverseur et kit douche

→ MR398CC_1

Five holes wall mounted bath filler with shower kit

Bordo vasca a parete cinque fori con deviatore e kit doccia

Bain/douche cinq trous avec inverseur et kit douche

A Hot water

Acqua calda
Eau chaude

B Spout

Bocca d'erogazione
Bec

C Cold water

Acqua fredda
Eau froide

D Diverter

Deviatore
Déviateur

E Hand shower

Doccino
Douchette







↑ MR031_2
 MR031_1
Dish soap holder
 Portasapone e posaogetti
 Porte- savon

MR001_1
 MR001_2
Soap-holder
 Porta sapone
 Porte savon

→ MR399CC_1
 ← **Free-standing bath filler with shower kit**
 Bordo vasca da terra con kit doccia
 Bain douche complet alimentation au sol

- | | |
|---|--|
| A Hot water
Acqua calda
Eau chaude | C Diverter
Deviatore
Déviateur |
| B Cold water
Acqua fredda
Eau froide | D Hand shower
Doccino
Douchette |



ARTICLE | ARTICOLO | ARTICLE

MR200



Monohole washbasin mixer complete with drain

Miscelatore lavabo monoforo completo di scarico automatico

Mitigeur lavabo complet avec bonde automatique

CODE / COEFFICIENT | CODICE / COEFFICIENTE |
CODE / COEFFICIENT

CC	MR200CC_1	MR200CC_2	13,5
PL	MR200PL_1	MR200PL_2	21,6
SS	MR200SS_1	MR200SS_2	16,9
ON	MR200ON_1	MR200ON_2	13,5
BO	MR200BO_1	MR200BO_2	16,2
NP	MR200NP_1	MR200NP_2	16,2
CF	MR200CF_1	MR200CF_2	20,3
CS	MR200CS_1	MR200CS_2	21,6
II	MR200II_1	MR200II_2	20,3
IS	MR200IS_1	MR200IS_2	21,6
RS	MR200RS_1	MR200RS_2	20,3
SR	MR200SR_1	MR200SR_2	21,6
OO	MR200OO_1	MR200OO_2	20,3
OS	MR200OS_1	MR200OS_2	21,6

PACKAGING
L: 353 mm
D: 225 mm
H: 226 mm

2,8 kg

MARBLE

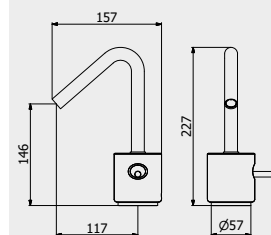
White
CarraraBlack
Marquina

PORTATE | WATER FLOW | DÉBIT D'EAU

1 BAR	2 BAR	3 BAR
4,2 l/m	5 l/m	5 l/m

ARTICLE | ARTICOLO | ARTICLE

MM200



Monohole washbasin mixer complete with drain

Miscelatore lavabo monoforo completo di scarico automatico

Mitigeur lavabo complet avec bonde automatique

CODE / COEFFICIENT | CODICE / COEFFICIENTE |
CODE / COEFFICIENT

CC	MM200CC_1	MM200CC_2	13,5
PL	MM200PL_1	MM200PL_2	21,6
SS	MM200SS_1	MM200SS_2	16,9
ON	MM200ON_1	MM200ON_2	13,5
BO	MM200BO_1	MM200BO_2	16,2
NP	MM200NP_1	MM200NP_2	16,2
CF	MM200CF_1	MM200CF_2	20,3
CS	MM200CS_1	MM200CS_2	21,6
II	MM200II_1	MM200II_2	20,3
IS	MM200IS_1	MM200IS_2	21,6
RS	MM200RS_1	MM200RS_2	20,3
SR	MM200SR_1	MM200SR_2	21,6
OO	MM200OO_1	MM200OO_2	20,3
OS	MM200OS_1	MM200OS_2	21,6

PACKAGING
L: 353 mm
D: 225 mm
H: 226 mm

2,8 kg

MARBLE

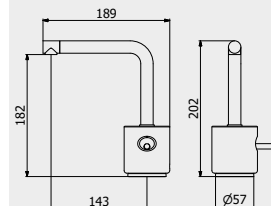
White
CarraraBlack
Marquina

PORTATE | WATER FLOW | DÉBIT D'EAU

1 BAR	2 BAR	3 BAR
4,2 l/m	5 l/m	5 l/m

ARTICLE | ARTICOLO | ARTICLE

MR202



Tall monohole washbasin mixer complete with drain

Miscelatore lavabo monoforo alto completo di scarico automatico

Mitigeur lavabo haut complet avec bonde automatique

CODE / COEFFICIENT | CODICE / COEFFICIENTE |
CODE / COEFFICIENT

CC	MR202CC_1	MR202CC_2	17,6
PL	MR202PL_1	MR202PL_2	28,2
SS	MR202SS_1	MR202SS_2	22,0
ON	MR202ON_1	MR202ON_2	17,6
BO	MR202BO_1	MR202BO_2	21,1
NP	MR202NP_1	MR202NP_2	21,1
CF	MR202CF_1	MR202CF_2	26,4
CS	MR202CS_1	MR202CS_2	28,2
II	MR202II_1	MR202II_2	26,4
IS	MR202IS_1	MR202IS_2	28,2
RS	MR202RS_1	MR202RS_2	26,4
SR	MR202SR_1	MR202SR_2	28,2
OO	MR202OO_1	MR202OO_2	26,4
OS	MR202OS_1	MR202OS_2	28,2

PACKAGING
L: 400 mm
D: 300 mm
H: 160 mm

3,5 kg

MARBLE

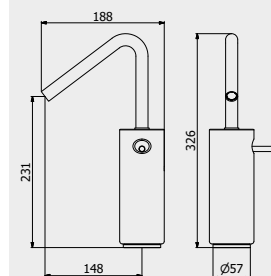
White
CarraraBlack
Marquina

PORTATE | WATER FLOW | DÉBIT D'EAU

1 BAR	2 BAR	3 BAR
4,2 l/m	5 l/m	5 l/m



ARTICLE | ARTICOLO | ARTICLE

MM202



Tall monohole washbasin mixer complete with drain
 Miscelatore lavabo monoforo alto completo di scarico automatico
 Mitigeur lavabo haut complet avec bonde automatique

CODE / COEFFICIENT | CODICE / COEFFICIENTE |
 CODE / COEFFICIENT

CC	MM202CC_1	MM202CC_2	17,6
PL	MM202PL_1	MM202PL_2	28,2
SS	MM202SS_1	MM202SS_2	22,0
ON	MM202ON_1	MM202ON_2	17,6
BO	MM202BO_1	MM202BO_2	21,1
NP	MM202NP_1	MM202NP_2	21,1
CF	MM202CF_1	MM202CF_2	26,4
CS	MM202CS_1	MM202CS_2	28,2
II	MM202II_1	MM202II_2	26,4
IS	MM202IS_1	MM202IS_2	28,2
RS	MM202RS_1	MM202RS_2	26,4
SR	MM202SR_1	MM202SR_2	28,2
OO	MM202OO_1	MM202OO_2	26,4
OS	MM202OS_1	MM202OS_2	28,2

PACKAGING

L: 400 mm
 D: 300 mm
 H: 160 mm

3,5 kg

MARBLE

White Carrara

Black Marquina

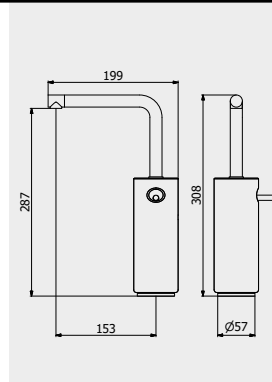

PORTATE | WATER FLOW | DÉBIT D'EAU

1 BAR	2 BAR	3 BAR
4,2 l/m	5 l/m	5 l/m

Marmo

ARTICLE | ARTICOLO | ARTICLE

MR306



Wall mounted widespread lavatory faucet
 Rubinetto lavabo da incasso
 Robinet de lavabo mural

CODE / COEFFICIENT | CODICE / COEFFICIENTE |
 CODE / COEFFICIENT

CC	MR306CC_1	MR306CC_2	23,1
PL	MR306PL_1	MR306PL_2	37,0
SS	MR306SS_1	MR306SS_2	28,9
ON	MR306ON_1	MR306ON_2	23,1
BO	MR306BO_1	MR306BO_2	27,7
NP	MR306NP_1	MR306NP_2	27,7
CF	MR306CF_1	MR306CF_2	34,7
CS	MR306CS_1	MR306CS_2	37,0
II	MR306II_1	MR306II_2	34,7
IS	MR306IS_1	MR306IS_2	37,0
RS	MR306RS_1	MR306RS_2	34,7
SR	MR306SR_1	MR306SR_2	37,0
OO	MR306OO_1	MR306OO_2	34,7
OS	MR306OS_1	MR306OS_2	37,0

PACKAGING

L: 470 mm
 D: 290 mm
 H: 160 mm

5 kg

MARBLE

White Carrara

Black Marquina

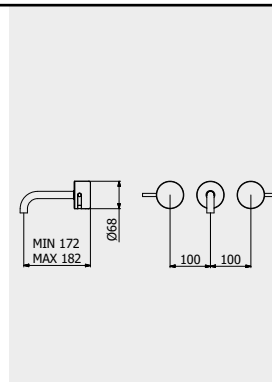

PORTATE | WATER FLOW | DÉBIT D'EAU

1 BAR	2 BAR	3 BAR
4,2 l/m	5 l/m	5 l/m

ARTICLE | ARTICOLO | ARTICLE

MR307



Wall mounted widespread lavatory faucet with long spout
 Rubinetto lavabo da incasso con bocca lunga
 Robinet de lavabo mural avec long bec

CODE / COEFFICIENT | CODICE / COEFFICIENTE |
 CODE / COEFFICIENT

CC	MR307CC_1	MR307CC_2	23,2
PL	MR307PL_1	MR307PL_2	37,1
SS	MR307SS_1	MR307SS_2	29,0
ON	MR307ON_1	MR307ON_2	23,2
BO	MR307BO_1	MR307BO_2	27,8
NP	MR307NP_1	MR307NP_2	27,8
CF	MR307CF_1	MR307CF_2	34,8
CS	MR307CS_1	MR307CS_2	37,1
II	MR307II_1	MR307II_2	34,8
IS	MR307IS_1	MR307IS_2	37,1
RS	MR307RS_1	MR307RS_2	34,8
SR	MR307SR_1	MR307SR_2	37,1
OO	MR307OO_1	MR307OO_2	34,8
OS	MR307OS_1	MR307OS_2	37,1

PACKAGING

L: 470 mm
 D: 290 mm
 H: 160 mm

5,1 kg

MARBLE

White Carrara

Black Marquina

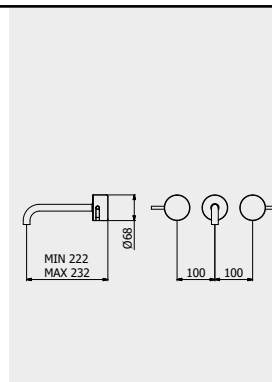

PORTATE | WATER FLOW | DÉBIT D'EAU

1 BAR	2 BAR	3 BAR
4,2 l/m	5 l/m	5 l/m

ARTICLE | ARTICOLO | ARTICLE

MR308



Wall mounted widespread lavatory faucet with short spout
Rubinetto lavabo da incasso con bocca corta
Robinet de lavabo mural avec court bec

CODE / COEFFICIENT | CODICE / COEFFICIENTE |
CODE / COEFFICIENT

CC	MR308CC_1	MR308CC_2	23,2
PL	MR308PL_1	MR308PL_2	37,1
SS	MR308SS_1	MR308SS_2	29,0
ON	MR308ON_1	MR308ON_2	23,2
BO	MR308BO_1	MR308BO_2	27,8
NP	MR308NP_1	MR308NP_2	27,8
CF	MR308CF_1	MR308CF_2	34,8
CS	MR308CS_1	MR308CS_2	37,1
II	MR308II_1	MR308II_2	34,8
IS	MR308IS_1	MR308IS_2	37,1
RS	MR308RS_1	MR308RS_2	34,8
SR	MR308SR_1	MR308SR_2	37,1
OO	MR308OO_1	MR308OO_2	34,8
OS	MR308OS_1	MR308OS_2	37,1

PACKAGING
L: 470 mm
D: 290 mm
H: 160 mm

4,9 kg

MARBLE

White
Carrara

Black
Marquina

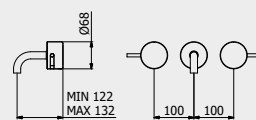

PORTATE | WATER FLOW | DÉBIT D'EAU

1 BAR	2 BAR	3 BAR
4,2 l/m	5 l/m	5 l/m

ARTICLE | ARTICOLO | ARTICLE

MR209



Mono hole wall mounted washbasin mixer
Miscelatore lavabo a parete monoforo
Mitigeur lavabo mural monotrou

CODE / COEFFICIENT | CODICE / COEFFICIENTE |
CODE / COEFFICIENT

CC	MR209CC_1	MR209CC_2	17,9
PL	MR209PL_1	MR209PL_2	28,6
SS	MR209SS_1	MR209SS_2	22,4
ON	MR209ON_1	MR209ON_2	17,9
BO	MR209BO_1	MR209BO_2	21,5
NP	MR209NP_1	MR209NP_2	21,5
CF	MR209CF_1	MR209CF_2	26,9
CS	MR209CS_1	MR209CS_2	28,6
II	MR209II_1	MR209II_2	26,9
IS	MR209IS_1	MR209IS_2	28,6
RS	MR209RS_1	MR209RS_2	26,9
SR	MR209SR_1	MR209SR_2	28,6
OO	MR209OO_1	MR209OO_2	26,9
OS	MR209OS_1	MR209OS_2	28,6

PACKAGING
L: 360 mm
D: 220 mm
H: 150 mm

3,8 kg

MARBLE

White
Carrara

Black
Marquina

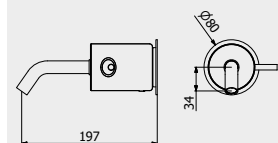

PORTATE | WATER FLOW | DÉBIT D'EAU

1 BAR	2 BAR	3 BAR
4,2 l/m	5 l/m	5 l/m

ARTICLE | ARTICOLO | ARTICLE

MM209



Mono hole wall mounted washbasin mixer
Miscelatore lavabo a parete monoforo
Mitigeur lavabo mural monotrou

CODE / COEFFICIENT | CODICE / COEFFICIENTE |
CODE / COEFFICIENT

CC	MM209CC_1	MM209CC_2	17,9
PL	MM209PL_1	MM209PL_2	28,6
SS	MM209SS_1	MM209SS_2	22,4
ON	MM209ON_1	MM209ON_2	17,9
BO	MM209BO_1	MM209BO_2	21,5
NP	MM209NP_1	MM209NP_2	21,5
CF	MM209CF_1	MM209CF_2	26,9
CS	MM209CS_1	MM209CS_2	28,6
II	MM209II_1	MM209II_2	26,9
IS	MM209IS_1	MM209IS_2	28,6
RS	MM209RS_1	MM209RS_2	26,9
SR	MM209SR_1	MM209SR_2	28,6
OO	MM209OO_1	MM209OO_2	26,9
OS	MM209OS_1	MM209OS_2	28,6

PACKAGING
L: 360 mm
D: 220 mm
H: 150 mm

3,8 kg

MARBLE

White
Carrara

Black
Marquina

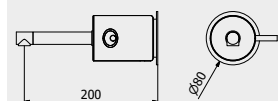

PORTATE | WATER FLOW | DÉBIT D'EAU

1 BAR	2 BAR	3 BAR
4,2 l/m	5 l/m	5 l/m



ARTICLE | ARTICOLO | ARTICLE

MR390



Three holes washbasin with tall spout

Lavabo tre fori a bocca alta

Lavabo trois trous bec haut

CODE / COEFFICIENT | CODICE / COEFFICIENTE |
CODE / COEFFICIENT

CC	MR390CC_1	MR390CC_2	23,7
PL	MR390PL_1	MR390PL_2	37,9
SS	MR390SS_1	MR390SS_2	29,6
ON	MR390ON_1	MR390ON_2	23,7
BO	MR390BO_1	MR390BO_2	28,4
NP	MR390NP_1	MR390NP_2	28,4
CF	MR390CF_1	MR390CF_2	35,6
CS	MR390CS_1	MR390CS_2	37,9
II	MR390II_1	MR390II_2	35,6
IS	MR390IS_1	MR390IS_2	37,9
RS	MR390RS_1	MR390RS_2	35,6
SR	MR390SR_1	MR390SR_2	37,9
OO	MR390OO_1	MR390OO_2	35,6
OS	MR390OS_1	MR390OS_2	37,9

PACKAGING

L: 470 mm
D: 290 mm
H: 160 mm

4,6 kg

MARBLE

White Carrara

Black Marquina

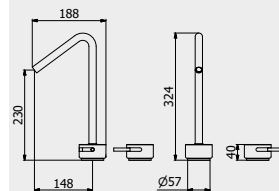

PORTATE | WATER FLOW | DÉBIT D'EAU

1 BAR	2 BAR	3 BAR
4,2 l/m	5 l/m	5 l/m

Marmo

ARTICLE | ARTICOLO | ARTICLE

MM390



Three holes washbasin with tall spout

Lavabo tre fori a bocca alta

Lavabo trois trous bec haut

CODE / COEFFICIENT | CODICE / COEFFICIENTE |
CODE / COEFFICIENT

CC	MM390CC_1	MM390CC_2	23,7
PL	MM390PL_1	MM390PL_2	37,9
SS	MM390SS_1	MM390SS_2	29,6
ON	MM390ON_1	MM390ON_2	23,7
BO	MM390BO_1	MM390BO_2	28,4
NP	MM390NP_1	MM390NP_2	28,4
CF	MM390CF_1	MM390CF_2	35,6
CS	MM390CS_1	MM390CS_2	37,9
II	MM390II_1	MM390II_2	35,6
IS	MM390IS_1	MM390IS_2	37,9
RS	MM390RS_1	MM390RS_2	35,6
SR	MM390SR_1	MM390SR_2	37,9
OO	MM390OO_1	MM390OO_2	35,6
OS	MM390OS_1	MM390OS_2	37,9

PACKAGING

L: 470 mm
D: 290 mm
H: 160 mm

4,6 kg

MARBLE

White Carrara

Black Marquina

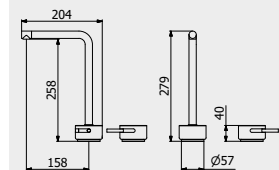

PORTATE | WATER FLOW | DÉBIT D'EAU

1 BAR	2 BAR	3 BAR
4,2 l/m	5 l/m	5 l/m

ARTICLE | ARTICOLO | ARTICLE

MR392



Three holes washbasin with short spout

Lavabo tre fori a bocca bassa

Lavabo trois trous bec bas

CODE / COEFFICIENT | CODICE / COEFFICIENTE |
CODE / COEFFICIENT

CC	MR392CC_1	MR392CC_2	22,8
PL	MR392PL_1	MR392PL_2	36,5
SS	MR392SS_1	MR392SS_2	28,5
ON	MR392ON_1	MR392ON_2	22,8
BO	MR392BO_1	MR392BO_2	27,4
NP	MR392NP_1	MR392NP_2	27,4
CF	MR392CF_1	MR392CF_2	34,2
CS	MR392CS_1	MR392CS_2	36,5
II	MR392II_1	MR392II_2	34,2
IS	MR392IS_1	MR392IS_2	36,5
RS	MR392RS_1	MR392RS_2	34,2
SR	MR392SR_1	MR392SR_2	36,5
OO	MR392OO_1	MR392OO_2	34,2
OS	MR392OS_1	MR392OS_2	36,5

PACKAGING

L: 470 mm
D: 290 mm
H: 160 mm

4,5 kg

MARBLE

White Carrara

Black Marquina

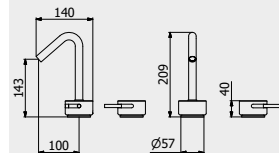

PORTATE | WATER FLOW | DÉBIT D'EAU

1 BAR	2 BAR	3 BAR
4,2 l/m	5 l/m	5 l/m

ARTICLE | ARTICOLO | ARTICLE

MM392



Three holes washbasin with short spout

Lavabo tre fori a bocca bassa

Lavabo trois trous bec bas

CODE / COEFFICIENT | CODICE / COEFFICIENTE |
CODE / COEFFICIENT

CC	MM392CC_1	MM392CC_2	22,8
PL	MM392PL_1	MM392PL_2	36,5
SS	MM392SS_1	MM392SS_2	28,5
ON	MM392ON_1	MM392ON_2	22,8
BO	MM392BO_1	MM392BO_2	27,4
NP	MM392NP_1	MM392NP_2	27,4
CF	MM392CF_1	MM392CF_2	34,2
CS	MM392CS_1	MM392CS_2	36,5
II	MM392II_1	MM392II_2	34,2
IS	MM392IS_1	MM392IS_2	36,5
RS	MM392RS_1	MM392RS_2	34,2
SR	MM392SR_1	MM392SR_2	36,5
OO	MM392OO_1	MM392OO_2	34,2
OS	MM392OS_1	MM392OS_2	36,5

PACKAGING

 L: 470 mm
D: 290 mm
H: 160 mm

4,5 kg

MARBLE

 White
Carrara

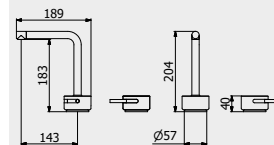
 Black
Marquina

PORTATE | WATER FLOW | DÉBIT D'EAU

1 BAR	2 BAR	3 BAR
4,2 l/m	5 l/m	5 l/m

ARTICLE | ARTICOLO | ARTICLE

MR220



Monohole bidet mixer complete with drain

Miscelatore bidet monoforo completo di scarico automatico

Mitigeur bidet complet avec bonde automatique

CODE / COEFFICIENT | CODICE / COEFFICIENTE |
CODE / COEFFICIENT

CC	MR220CC_1	MR220CC_2	13,5
PL	MR220PL_1	MR220PL_2	21,6
SS	MR220SS_1	MR220SS_2	16,9
ON	MR220ON_1	MR220ON_2	13,5
BO	MR220BO_1	MR220BO_2	16,2
NP	MR220NP_1	MR220NP_2	16,2
CF	MR220CF_1	MR220CF_2	20,3
CS	MR220CS_1	MR220CS_2	21,6
II	MR220II_1	MR220II_2	20,3
IS	MR220IS_1	MR220IS_2	21,6
RS	MR220RS_1	MR220RS_2	20,3
SR	MR220SR_1	MR220SR_2	21,6
OO	MR220OO_1	MR220OO_2	20,3
OS	MR220OS_1	MR220OS_2	21,6

PACKAGING

 L: 353 mm
D: 225 mm
H: 226 mm

2,6 kg

MARBLE

 White
Carrara

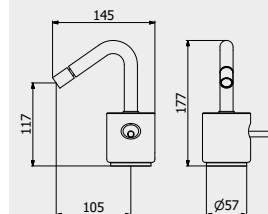
 Black
Marquina

PORTATE | WATER FLOW | DÉBIT D'EAU

1 BAR	2 BAR	3 BAR
4,2 l/m	5 l/m	5 l/m

ARTICLE | ARTICOLO | ARTICLE

MM220



Monohole bidet mixer complete with drain

Miscelatore bidet monoforo completo di scarico automatico

Mitigeur bidet complet avec bonde automatique

CODE / COEFFICIENT | CODICE / COEFFICIENTE |
CODE / COEFFICIENT

CC	MM220CC_1	MM220CC_2	13,5
PL	MM220PL_1	MM220PL_2	21,6
SS	MM220SS_1	MM220SS_2	16,9
ON	MM220ON_1	MM220ON_2	13,5
BO	MM220BO_1	MM220BO_2	16,2
NP	MM220NP_1	MM220NP_2	16,2
CF	MM220CF_1	MM220CF_2	20,3
CS	MM220CS_1	MM220CS_2	21,6
II	MM220II_1	MM220II_2	20,3
IS	MM220IS_1	MM220IS_2	21,6
RS	MM220RS_1	MM220RS_2	20,3
SR	MM220SR_1	MM220SR_2	21,6
OO	MM220OO_1	MM220OO_2	20,3
OS	MM220OS_1	MM220OS_2	21,6

PACKAGING

 L: 353 mm
D: 225 mm
H: 226 mm

2,6 kg

MARBLE

 White
Carrara

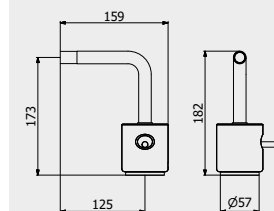
 Black
Marquina

PORTATE | WATER FLOW | DÉBIT D'EAU

1 BAR	2 BAR	3 BAR
4,2 l/m	5 l/m	5 l/m



ARTICLE | ARTICOLO | ARTICLE

MR393



Three holes bidet with adjustable spout
Bidet tre fori con bocca snodabile
Bidet trois trous



CODE / COEFFICIENT | CODICE / COEFFICIENTE |
CODE / COEFFICIENT

CC	MR393CC_1	MR393CC_2	22,2
PL	MR393PL_1	MR393PL_2	35,5
SS	MR393SS_1	MR393SS_2	27,8
ON	MR393ON_1	MR393ON_2	22,2
BO	MR393BO_1	MR393BO_2	26,6
NP	MR393NP_1	MR393NP_2	26,6
CF	MR393CF_1	MR393CF_2	33,3
CS	MR393CS_1	MR393CS_2	35,5
II	MR393II_1	MR393II_2	33,3
IS	MR393IS_1	MR393IS_2	35,5
RS	MR393RS_1	MR393RS_2	33,3
SR	MR393SR_1	MR393SR_2	35,5
OO	MR393OO_1	MR393OO_2	33,3
OS	MR393OS_1	MR393OS_2	35,5

PACKAGING

L: 470 mm
D: 290 mm
H: 160 mm

4,3 kg

MARBLE

White
Carrara

Black
Marquina

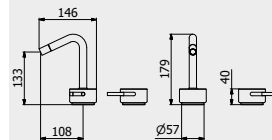

PORTATE | WATER FLOW | DÉBIT D'EAU

1 BAR	2 BAR	3 BAR
4,2 l/m	5 l/m	5 l/m

Marmo

ARTICLE | ARTICOLO | ARTICLE

MM393



Three holes bidet with adjustable spout
Bidet tre fori con bocca snodabile
Bidet trois trous



CODE / COEFFICIENT | CODICE / COEFFICIENTE |
CODE / COEFFICIENT

CC	MM393CC_1	MM393CC_2	22,2
PL	MM393PL_1	MM393PL_2	35,5
SS	MM393SS_1	MM393SS_2	27,8
ON	MM393ON_1	MM393ON_2	22,2
BO	MM393BO_1	MM393BO_2	26,6
NP	MM393NP_1	MM393NP_2	26,6
CF	MM393CF_1	MM393CF_2	33,3
CS	MM393CS_1	MM393CS_2	35,5
II	MM393II_1	MM393II_2	33,3
IS	MM393IS_1	MM393IS_2	35,5
RS	MM393RS_1	MM393RS_2	33,3
SR	MM393SR_1	MM393SR_2	35,5
OO	MM393OO_1	MM393OO_2	33,3
OS	MM393OS_1	MM393OS_2	35,5

PACKAGING

L: 470 mm
D: 290 mm
H: 160 mm

4,3 kg

MARBLE

White
Carrara

Black
Marquina

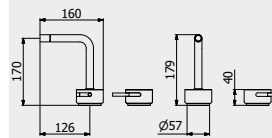

PORTATE | WATER FLOW | DÉBIT D'EAU

1 BAR	2 BAR	3 BAR
4,2 l/m	5 l/m	5 l/m

ARTICLE | ARTICOLO | ARTICLE

MR300



Exposed parts for manual wall mixer
Set di parti esterne per miscelatore a parete ad una via
Partie extérieure pour mitigeur encastré à une voie



CODE / COEFFICIENT | CODICE / COEFFICIENTE |
CODE / COEFFICIENT

CC	EMR300CC_19	EMR300CC_20	5,5
PL	EMR300PL_19	EMR300PL_20	8,8
SS	EMR300SS_19	EMR300SS_20	6,9
ON	EMR300ON_19	EMR300ON_20	5,5
BO	EMR300BO_19	EMR300BO_20	6,6
NP	EMR300NP_19	EMR300NP_20	6,6
CF	EMR300CF_19	EMR300CF_20	8,3
CS	EMR300CS_19	EMR300CS_20	8,8
II	EMR300II_19	EMR300II_20	8,3
IS	EMR300IS_19	EMR300IS_20	8,8
RS	EMR300RS_19	EMR300RS_20	8,3
SR	EMR300SR_19	EMR300SR_20	8,8
OO	EMR300OO_19	EMR300OO_20	8,3
OS	EMR300OS_19	EMR300OS_20	8,8

PACKAGING

L: 240 mm
D: 215 mm
H: 110 mm

1,6 kg

MARBLE

White
Carrara

Black
Marquina

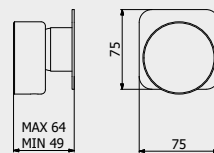

PORTATE | WATER FLOW | DÉBIT D'EAU

1 BAR	2 BAR	3 BAR
11,5 l/m	16,3 l/m	20 l/m

Built-in body to be purchased separately
Corpo incasso da acquistare separatamente
Corps intégré à acheter séparément



CODICE | CODE | CODE

INC300XXN_19

COEFFICIENT | COEFFICIENTE | COEFFICIENT

1,8

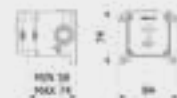

ARTICLE | ARTICOLO | ARTICLE

MR310



Exposed parts for manual wall mixer with two ways diverter
Miscelatore doccia a parete con deviatore due vie
Mitigeur douche mural deux voies avec inverseur

CODE / COEFFICIENT | CODICE / COEFFICIENTE |
CODE / COEFFICIENT

CC	EMR310CC_19	EMR310CC_20	7,9
PL	EMR310PL_19	EMR310PL_20	12,6
SS	EMR310SS_19	EMR310SS_20	9,9
ON	EMR310ON_19	EMR310ON_20	7,9
BO	EMR310BO_19	EMR310BO_20	9,5
NP	EMR310NP_19	EMR310NP_20	9,5
CF	EMR310CF_19	EMR310CF_20	11,9
CS	EMR310CS_19	EMR310CS_20	12,6
II	EMR310II_19	EMR310II_20	11,9
IS	EMR310IS_19	EMR310IS_20	12,6
RS	EMR310RS_19	EMR310RS_20	11,9
SR	EMR310SR_19	EMR310SR_20	12,6
OO	EMR310OO_19	EMR310OO_20	11,9
OS	EMR310OS_19	EMR310OS_20	12,6

 L: 240 mm
D: 215 mm
H: 110 mm

2,4 kg

MARBLE

 White
Carrara

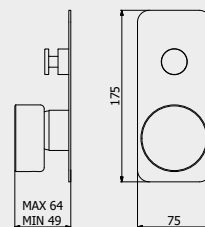
 Black
Marquina

PORTATE | WATER FLOW | DÉBIT D'EAU

1 BAR	2 BAR	3 BAR
9,2 l/m	12,8 l/m	16 l/m

Built-in body to be purchased separately

Corpo incasso da acquistare separatamente

Corps intégré à acheter séparément



CODICE | CODE | CODE

INC310XXXN_19

COEFFICIENT | COEFFICIENTE | COEFFICIENT

3,3

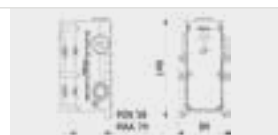

ARTICLE | ARTICOLO | ARTICLE

MR312



Exposed parts for manual wall mixer with three ways diverter
Set di parti esterne per miscelatore a parete a tre vie
Mitigeur douche mural trois voies avec inverseur

CODE / COEFFICIENT | CODICE / COEFFICIENTE |
CODE / COEFFICIENT

CC	EMR312CC_19	EMR312CC_20	9,2
PL	EMR312PL_19	EMR312PL_20	14,7
SS	EMR312SS_19	EMR312SS_20	11,5
ON	EMR312ON_19	EMR312ON_20	9,2
BO	EMR312BO_19	EMR312BO_20	11,0
NP	EMR312NP_19	EMR312NP_20	11,0
CF	EMR312CF_19	EMR312CF_20	13,8
CS	EMR312CS_19	EMR312CS_20	14,7
II	EMR312II_19	EMR312II_20	13,8
IS	EMR312IS_19	EMR312IS_20	14,7
RS	EMR312RS_19	EMR312RS_20	13,8
SR	EMR312SR_19	EMR312SR_20	14,7
OO	EMR312OO_19	EMR312OO_20	13,8
OS	EMR312OS_19	EMR312OS_20	14,7

 L: 240 mm
D: 215 mm
H: 110 mm

2,4 kg

MARBLE

 White
Carrara

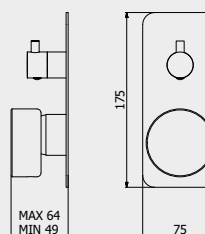
 Black
Marquina

PORTATE | WATER FLOW | DÉBIT D'EAU

1 BAR	2 BAR	3 BAR
9,5 l/m	13,4 l/m	16,9 l/m

Built-in body to be purchased separately

Corpo incasso da acquistare separatamente

Corps intégré à acheter séparément



CODICE | CODE | CODE

INC312XXXN_19

COEFFICIENT | COEFFICIENTE | COEFFICIENT

3,3

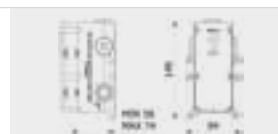

ARTICLE | ARTICOLO | ARTICLE

MR400



Two holes wall mounted shower
Comandi doccia a parete due fori
Melangeur deux trous douche

CODE / COEFFICIENT | CODICE / COEFFICIENTE |
CODE / COEFFICIENT

CC	MR400CC_1	MR400CC_2	13,5
PL	MR400PL_1	MR400PL_2	21,6
SS	MR400SS_1	MR400SS_2	16,9
ON	MR400ON_1	MR400ON_2	13,5
BO	MR400BO_1	MR400BO_2	16,2
NP	MR400NP_1	MR400NP_2	16,2
CF	MR400CF_1	MR400CF_2	20,3
CS	MR400CS_1	MR400CS_2	21,6
II	MR400II_1	MR400II_2	20,3
IS	MR400IS_1	MR400IS_2	21,6
RS	MR400RS_1	MR400RS_2	20,3
SR	MR400SR_1	MR400SR_2	21,6
OO	MR400OO_1	MR400OO_2	20,3
OS	MR400OS_1	MR400OS_2	21,6

 L: 240 mm
D: 215 mm
H: 110 mm

2,8 kg

MARBLE

 White
Carrara

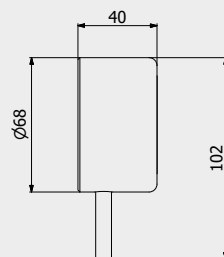
 Black
Marquina

PORTATE | WATER FLOW | DÉBIT D'EAU

1 BAR	2 BAR	3 BAR
28 l/m	40 l/m	49,3 l/m



ARTICLE | ARTICOLO | ARTICLE

MR313



Exposed parts for manual wall mixer with 2 ways with shower kit
Set di parti esterne per miscelatore a parete a due vie completo di kit doccia
Partie extérieure pour mitigeur encastré à deux voies avec douchette

CODE / COEFFICIENT | CODICE / COEFFICIENTE |
CODE / COEFFICIENT

CC	EMR313CC_19	EMR313CC_20	12,8
PL	EMR313PL_19	EMR313PL_20	20,5
SS	EMR313SS_19	EMR313SS_20	16,0
ON	EMR313ON_19	EMR313ON_20	12,8
BO	EMR313BO_19	EMR313BO_20	15,4
NP	EMR313NP_19	EMR313NP_20	15,4
CF	EMR313CF_19	EMR313CF_20	19,2
CS	EMR313CS_19	EMR313CS_20	20,5
II	EMR313II_19	EMR313II_20	19,2
IS	EMR313IS_19	EMR313IS_20	20,5
RS	EMR313RS_19	EMR313RS_20	19,2
SR	EMR313SR_19	EMR313SR_20	20,5
OO	EMR313OO_19	EMR313OO_20	19,2
OS	EMR313OS_19	EMR313OS_20	20,5

PACKAGING
L: 353 mm
D: 225 mm
H: 226 mm

3,2 kg

MARBLE

White Carrara
Black Marquina

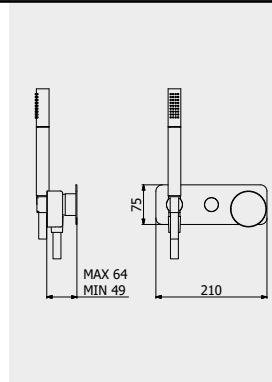

PORTATE | WATER FLOW | DÉBIT D'EAU

1 BAR	2 BAR	3 BAR
10 l/m	14,1 l/m	17,2 l/m

Marmo

Built-in body to be purchased separately

Corpo incasso da acquistare separatamente
Corps intégré à acheter séparément



CODICE | CODE | CODE

INC313XXXN_19

COEFFICIENT | COEFFICIENTE | COEFFICIENT

3,6



ARTICLE | ARTICOLO | ARTICLE

MR314



Exposed parts for manual wall mixer with 3 ways with shower kit
Set di parti esterne per miscelatore a parete a tre vie completo di kit doccia
Partie extérieure pour mitigeur encastré à trois voies avec douchette

CODE / COEFFICIENT | CODICE / COEFFICIENTE |
CODE / COEFFICIENT

CC	EMR314CC_19	EMR314CC_20	15,8
PL	EMR314PL_19	EMR314PL_20	25,3
SS	EMR314SS_19	EMR314SS_20	19,8
ON	EMR314ON_19	EMR314ON_20	15,8
BO	EMR314BO_19	EMR314BO_20	19,0
NP	EMR314NP_19	EMR314NP_20	19,0
CF	EMR314CF_19	EMR314CF_20	23,7
CS	EMR314CS_19	EMR314CS_20	25,3
II	EMR314II_19	EMR314II_20	23,7
IS	EMR314IS_19	EMR314IS_20	25,3
RS	EMR314RS_19	EMR314RS_20	23,7
SR	EMR314SR_19	EMR314SR_20	25,3
OO	EMR314OO_19	EMR314OO_20	23,7
OS	EMR314OS_19	EMR314OS_20	25,3

PACKAGING
L: 353 mm
D: 225 mm
H: 226 mm

3,4 kg

MARBLE

White Carrara
Black Marquina

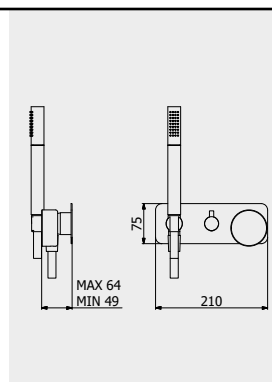

PORTATE | WATER FLOW | DÉBIT D'EAU

1 BAR	2 BAR	3 BAR
8,3 l/m	11,7 l/m	14,3 l/m

Built-in body to be purchased separately

Corpo incasso da acquistare separatamente
Corps intégré à acheter séparément



CODICE | CODE | CODE

INC314XXXN_19

COEFFICIENT | COEFFICIENTE | COEFFICIENT

3,7



ARTICLE | ARTICOLO | ARTICLE

MR410



Three holes wall mounted shower with two ways diverter
Tre rubinetti a parete per doccia con deviatore a due vie
Melangeur trois trous douche avec inverseur deux voies

CODE / COEFFICIENT | CODICE / COEFFICIENTE |
CODE / COEFFICIENT

CC	MR410CC_1	MR410CC_2	21,6
PL	MR410PL_1	MR410PL_2	34,6
SS	MR410SS_1	MR410SS_2	27,0
ON	MR410ON_1	MR410ON_2	21,6
BO	MR410BO_1	MR410BO_2	25,9
NP	MR410NP_1	MR410NP_2	25,9
CF	MR410CF_1	MR410CF_2	32,4
CS	MR410CS_1	MR410CS_2	34,6
II	MR410II_1	MR410II_2	32,4
IS	MR410IS_1	MR410IS_2	34,6
RS	MR410RS_1	MR410RS_2	32,4
SR	MR410SR_1	MR410SR_2	34,6
OO	MR410OO_1	MR410OO_2	32,4
OS	MR410OS_1	MR410OS_2	34,6

PACKAGING
L: 240 mm
D: 215 mm
H: 110 mm

3,3 kg

MARBLE

White Carrara
Black Marquina

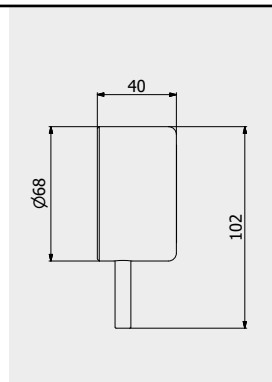

PORTATE | WATER FLOW | DÉBIT D'EAU

1 BAR	2 BAR	3 BAR
16 l/m	22,4 l/m	27,4 l/m

ARTICLE | ARTICOLO | ARTICLE

MR396



Five holes bath filler with diverter and shower head

Bordo vasca cinque fori con deviatore e doccino integrato

Bain/douche cinq trous avec inverseur et Kit Douche

CODE / COEFFICIENT | CODICE / COEFFICIENTE |
CODE / COEFFICIENT

CC	MR396CC_1	MR396CC_2	41,8
PL	MR396PL_1	MR396PL_2	66,9
SS	MR396SS_1	MR396SS_2	52,3
ON	MR396ON_1	MR396ON_2	41,8
BO	MR396BO_1	MR396BO_2	50,2
NP	MR396NP_1	MR396NP_2	50,2
CF	MR396CF_1	MR396CF_2	62,7
CS	MR396CS_1	MR396CS_2	66,9
II	MR396II_1	MR396II_2	62,7
IS	MR396IS_1	MR396IS_2	66,9
RS	MR396RS_1	MR396RS_2	62,7
SR	MR396SR_1	MR396SR_2	66,9
OO	MR396OO_1	MR396OO_2	62,7
OS	MR396OS_1	MR396OS_2	66,9

PACKAGING
L: 685 mm
D: 345 mm
H: 168 mm

7,2 kg

MARBLE

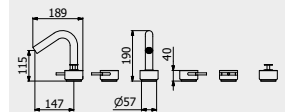
White
CarraraBlack
Marquina

PORTATE | WATER FLOW | DÉBIT D'EAU

1 BAR	2 BAR	3 BAR
13 l/m	18,8 l/m	23,1 l/m

ARTICLE | ARTICOLO | ARTICLE

MM396



Five holes bath filler with diverter and shower head

Bordo vasca cinque fori con deviatore e doccino integrato

Bain/douche cinq trous avec inverseur et Kit Douche

CODE / COEFFICIENT | CODICE / COEFFICIENTE |
CODE / COEFFICIENT

CC	MM396CC_1	MM396CC_2	41,8
PL	MM396PL_1	MM396PL_2	66,9
SS	MM396SS_1	MM396SS_2	52,3
ON	MM396ON_1	MM396ON_2	41,8
BO	MM396BO_1	MM396BO_2	50,2
NP	MM396NP_1	MM396NP_2	50,2
CF	MM396CF_1	MM396CF_2	62,7
CS	MM396CS_1	MM396CS_2	66,9
II	MM396II_1	MM396II_2	62,7
IS	MM396IS_1	MM396IS_2	66,9
RS	MM396RS_1	MM396RS_2	62,7
SR	MM396SR_1	MM396SR_2	66,9
OO	MM396OO_1	MM396OO_2	62,7
OS	MM396OS_1	MM396OS_2	66,9

PACKAGING
L: 685 mm
D: 345 mm
H: 168 mm

7,2 kg

MARBLE

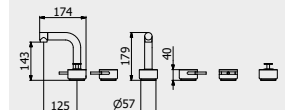
White
CarraraBlack
Marquina

PORTATE | WATER FLOW | DÉBIT D'EAU

1 BAR	2 BAR	3 BAR
13 l/m	18,8 l/m	23,1 l/m

ARTICLE | ARTICOLO | ARTICLE

MR397



Four holes bath filler with overflow outlet connection, diverter and showered

Bordo vasca quattro fori per colonna riempimento con deviatore e doccino

Bain/douche 4 trous avec inverseur et Kit Douche pour remplissage ETP

CODE / COEFFICIENT | CODICE / COEFFICIENTE |
CODE / COEFFICIENT

CC	MR397CC_1	MR397CC_2	30,8
PL	MR397PL_1	MR397PL_2	49,3
SS	MR397SS_1	MR397SS_2	38,5
ON	MR397ON_1	MR397ON_2	30,8
BO	MR397BO_1	MR397BO_2	37,0
NP	MR397NP_1	MR397NP_2	37,0
CF	MR397CF_1	MR397CF_2	46,2
CS	MR397CS_1	MR397CS_2	49,3
II	MR397II_1	MR397II_2	46,2
IS	MR397IS_1	MR397IS_2	49,3
RS	MR397RS_1	MR397RS_2	46,2
SR	MR397SR_1	MR397SR_2	49,3
OO	MR397OO_1	MR397OO_2	46,2
OS	MR397OS_1	MR397OS_2	49,3

PACKAGING
L: 685 mm
D: 345 mm
H: 168 mm

6,8 kg

MARBLE

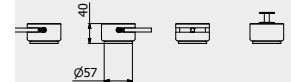
White
CarraraBlack
Marquina

PORTATE | WATER FLOW | DÉBIT D'EAU

1 BAR	2 BAR	3 BAR
16 l/m	23 l/m	28 l/m



ARTICLE | ARTICOLO | ARTICLE

MR398



Five holes wall mounted bath filler with diverter and shower head
Bordo vasca cinque fori a parete con deviatore e doccino integrato
Bain/douche cinq trous avec inverseur et Kit Douche



CODE / COEFFICIENT CODICE / COEFFICIENTE		PACKAGING
CODE / COEFFICIENT		
CC	MR398CC_1 MR398CC_2	36,1
PL	MR398PL_1 MR398PL_2	57,8
SS	MR398SS_1 MR398SS_2	45,1
ON	MR398ON_1 MR398ON_2	36,1
BO	MR398BO_1 MR398BO_2	43,3
NP	MR398NP_1 MR398NP_2	43,3
CF	MR398CF_1 MR398CF_2	54,2
CS	MR398CS_1 MR398CS_2	57,8
II	MR398II_1 MR398II_2	54,2
IS	MR398IS_1 MR398IS_2	57,8
RS	MR398RS_1 MR398RS_2	54,2
SR	MR398SR_1 MR398SR_2	57,8
OO	MR398OO_1 MR398OO_2	54,2
OS	MR398OS_1 MR398OS_2	57,8

PACKAGING
L: 470 mm
D: 290 mm
H: 160 mm
5,8 kg

MARBLE
White Carrara
Black Marquina

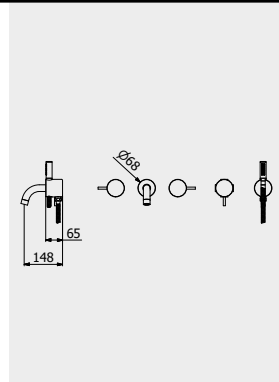

PORTATE | WATER FLOW | DÉBIT D'EAU

1 BAR	2 BAR	3 BAR
12,1 l/m	17,1 l/m	21 l/m

Marmo

ARTICLE | ARTICOLO | ARTICLE

MR399



Free-standing bath filler
Bordo vasca da terra con doccino integrato
Bain douche complet alimentation au sol



CODE / COEFFICIENT CODICE / COEFFICIENTE		PACKAGING
CODE / COEFFICIENT		
CC	MR399CC_1 MR399CC_2	79,6
PL	MR399PL_1 MR399PL_2	127,4
SS	MR399SS_1 MR399SS_2	99,5
ON	MR399ON_1 MR399ON_2	79,6
BO	MR399BO_1 MR399BO_2	95,5
NP	MR399NP_1 MR399NP_2	95,5
CF	MR399CF_1 MR399CF_2	119,4
CS	MR399CS_1 MR399CS_2	127,4
II	MR399II_1 MR399II_2	119,4
IS	MR399IS_1 MR399IS_2	127,4
RS	MR399RS_1 MR399RS_2	119,4
SR	MR399SR_1 MR399SR_2	127,4
OO	MR399OO_1 MR399OO_2	119,4
OS	MR399OS_1 MR399OS_2	127,4

PACKAGING
L: 900 mm
D: 470 mm
H: 470 mm
21 kg

MARBLE
White Carrara
Black Marquina

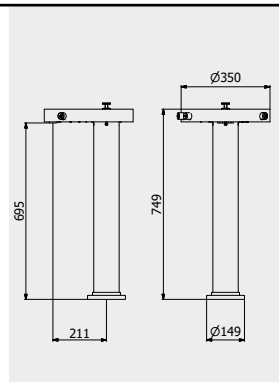

PORTATE | WATER FLOW | DÉBIT D'EAU

1 BAR	2 BAR	3 BAR
13,9 l/m	19,8 l/m	24,5 l/m

ARTICLE | ARTICOLO | ARTICLE

MR022



Duplex MARMO
Duplex MARMO
Duplex MARMO



CODE / COEFFICIENT CODICE / COEFFICIENTE		PACKAGING
CODE / COEFFICIENT		
CC	MR022CC_1 MR022CC_2	8,6
PL	MR022PL_1 MR022PL_2	13,8
SS	MR022SS_1 MR022SS_2	10,8
ON	MR022ON_1 MR022ON_2	8,6
BO	MR022BO_1 MR022BO_2	10,3
NP	MR022NP_1 MR022NP_2	10,3
CF	MR022CF_1 MR022CF_2	12,9
CS	MR022CS_1 MR022CS_2	13,8
II	MR022II_1 MR022II_2	12,9
IS	MR022IS_1 MR022IS_2	13,8
RS	MR022RS_1 MR022RS_2	12,9
SR	MR022SR_1 MR022SR_2	13,8
OO	MR022OO_1 MR022OO_2	12,9
OS	MR022OS_1 MR022OS_2	13,8

PACKAGING
L: 360 mm
D: 220 mm
H: 150 mm
1,8 kg

MARBLE
White Carrara
Black Marquina

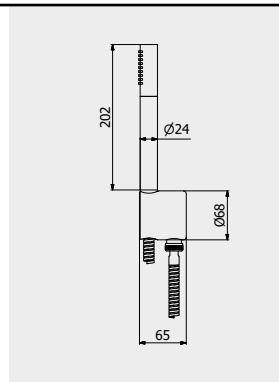

PORTATE | WATER FLOW | DÉBIT D'EAU

1 BAR	2 BAR	3 BAR
13,9 l/m	19,8 l/m	24,5 l/m

ARTICLE | ARTICOLO | ARTICLE

MR320



Wall mounted spout

Bocca d'erogazione a parete

Bec de remplissage mural

CODE / COEFFICIENT | CODICE / COEFFICIENTE |
CODE / COEFFICIENT

CC	MR320CC_1	MR320CC_2	5,6
PL	MR320PL_1	MR320PL_2	9,0
SS	MR320SS_1	MR320SS_2	7,0
ON	MR320ON_1	MR320ON_2	5,6
BO	MR320BO_1	MR320BO_2	6,7
NP	MR320NP_1	MR320NP_2	6,7
CF	MR320CF_1	MR320CF_2	8,4
CS	MR320CS_1	MR320CS_2	9,0
II	MR320II_1	MR320II_2	8,4
IS	MR320IS_1	MR320IS_2	9,0
RS	MR320RS_1	MR320RS_2	8,4
SR	MR320SR_1	MR320SR_2	9,0
OO	MR320OO_1	MR320OO_2	8,4
OS	MR320OS_1	MR320OS_2	9,0

PACKAGING

 L: 425 mm
D: 188 mm
H: 98 mm

1,1 kg

MARBLE

 White
Carrara

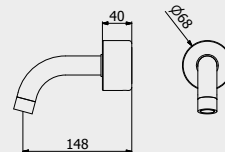
 Black
Marquina

PORTATE | WATER FLOW | DÉBIT D'EAU

1 BAR	2 BAR	3 BAR
6,5 l/m	8 l/m	8 l/m

ARTICLE | ARTICOLO | ARTICLE

MR321



Short wall mounted spout

Bocca d'erogazione corta a parete

Bec de remplissage mural court

CODE / COEFFICIENT | CODICE / COEFFICIENTE |
CODE / COEFFICIENT

CC	MR321CC_1	MR321CC_2	5,9
PL	MR321PL_1	MR321PL_2	9,4
SS	MR321SS_1	MR321SS_2	7,4
ON	MR321ON_1	MR321ON_2	5,9
BO	MR321BO_1	MR321BO_2	7,1
NP	MR321NP_1	MR321NP_2	7,1
CF	MR321CF_1	MR321CF_2	8,9
CS	MR321CS_1	MR321CS_2	9,4
II	MR321II_1	MR321II_2	8,9
IS	MR321IS_1	MR321IS_2	9,4
RS	MR321RS_1	MR321RS_2	8,9
SR	MR321SR_1	MR321SR_2	9,4
OO	MR321OO_1	MR321OO_2	8,9
OS	MR321OS_1	MR321OS_2	9,4

PACKAGING

 L: 425 mm
D: 188 mm
H: 98 mm

1 kg

MARBLE

 White
Carrara

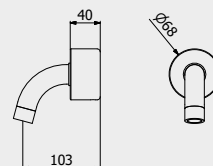
 Black
Marquina

PORTATE | WATER FLOW | DÉBIT D'EAU

1 BAR	2 BAR	3 BAR
6,5 l/m	8 l/m	8 l/m

ARTICLE | ARTICOLO | ARTICLE

MR322



Long wall mounted spout

Bocca d'erogazione lunga a parete

Bec de remplissage mural long

CODE / COEFFICIENT | CODICE / COEFFICIENTE |
CODE / COEFFICIENT

CC	MR322CC_1	MR322CC_2	5,9
PL	MR322PL_1	MR322PL_2	9,4
SS	MR322SS_1	MR322SS_2	7,4
ON	MR322ON_1	MR322ON_2	5,9
BO	MR322BO_1	MR322BO_2	7,1
NP	MR322NP_1	MR322NP_2	7,1
CF	MR322CF_1	MR322CF_2	8,9
CS	MR322CS_1	MR322CS_2	9,4
II	MR322II_1	MR322II_2	8,9
IS	MR322IS_1	MR322IS_2	9,4
RS	MR322RS_1	MR322RS_2	8,9
SR	MR322SR_1	MR322SR_2	9,4
OO	MR322OO_1	MR322OO_2	8,9
OS	MR322OS_1	MR322OS_2	9,4

PACKAGING

 L: 425 mm
D: 188 mm
H: 98 mm

1,2 kg

MARBLE

 White
Carrara

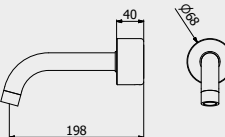
 Black
Marquina

PORTATE | WATER FLOW | DÉBIT D'EAU

1 BAR	2 BAR	3 BAR
6,5 l/m	8 l/m	8 l/m



ARTICLE | ARTICOLO | ARTICLE

MR706



Exposed parts for bidet spray complete with mixer
Set di parti esterne per Idroscopio igienico con miscelatore
Partie extérieure pour douchette hygiénique avec mitigeur

CODE / COEFFICIENT | CODICE / COEFFICIENTE |
CODE / COEFFICIENT

CC	EMR706CC_19	EMR706CC_20	11,6
PL	EMR706PL_19	EMR706PL_20	18,6
SS	EMR706SS_19	EMR706SS_20	14,5
ON	EMR706ON_19	EMR706ON_20	11,6
BO	EMR706BO_19	EMR706BO_20	13,9
NP	EMR706NP_19	EMR706NP_20	13,9
CF	EMR706CF_19	EMR706CF_20	17,4
CS	EMR706CS_19	EMR706CS_20	18,6
II	EMR706II_19	EMR706II_20	17,4
IS	EMR706IS_19	EMR706IS_20	18,6
RS	EMR706RS_19	EMR706RS_20	17,4
SR	EMR706SR_19	EMR706SR_20	18,6
OO	EMR706OO_19	EMR706OO_20	17,4
OS	EMR706OS_19	EMR706OS_20	18,6

PACKAGING
L: 370 mm
D: 270 mm
H: 80 mm

3,5 kg

MARBLE

White Carrara

Black Marquina

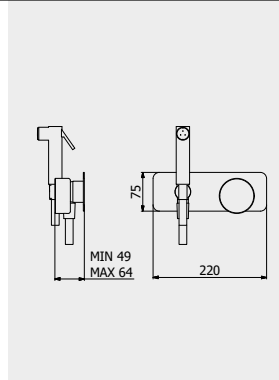

PORTATE | WATER FLOW | DÉBIT D'EAU

1 BAR	2 BAR	3 BAR
2,3 l/m	3,2 l/m	4 l/m

Marmo

Built-in body to be purchased separately

Corpo incasso da acquistare separatamente

Corps intégré à acheter séparément



CODICE | CODE | CODE

INC206XXXN_19

COEFFICIENT | COEFFICIENTE | COEFFICIENT

2,9

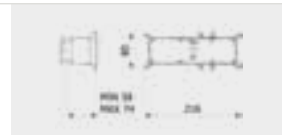

MARMO / ACCESSORIES COLLECTION



ARTICLE | ARTICOLO | ARTICLE

MR001



Soap-holder

Porta sapone

Porte de savon

CODE / COEFFICIENT | CODICE / COEFFICIENTE |
CODE / COEFFICIENTBlack
MarquinaWhite
Carrara

MR001_1

MR001_2

7,3

PACKAGING

 L: 265 mm
D: 260 mm
H: 70 mm

1,719 kg

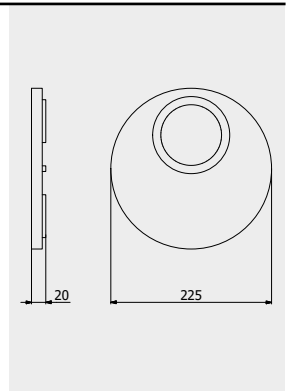

ARTICLE | ARTICOLO | ARTICLE

MR031



Dish soap holder

Portasapone e posaogetti

Porte- savon

CODE / COEFFICIENT | CODICE / COEFFICIENTE |
CODE / COEFFICIENTBlack
MarquinaWhite
Carrara

MR031_1

MR031_2

6,4

PACKAGING

 L: 340 mm
D: 180 mm
H: 70 mm

1,164 kg

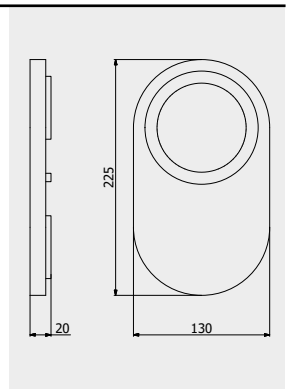

ARTICLE | ARTICOLO | ARTICLE

MR008



Robe Hook

Appendino a parete

Cintre

CODE / COEFFICIENT | CODICE / COEFFICIENTE |
CODE / COEFFICIENTBlack
MarquinaWhite
Carrara

MR008_1

MR008_2

3,0

PACKAGING

 L: 150 mm
D: 190 mm
H: 98 mm

0,367 kg

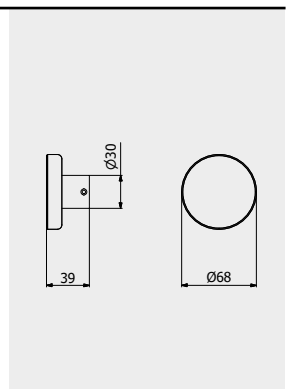



INDUSTRIA

Play the game of combinations.

Gioca al gioco delle combinazioni.
Joue les jeux des combinaisons

Collection of great versatility and taste, INDUSTRIA combines some more traditional and linear forms with the charm of the knurls that enhance its shape. Available in eleven different finishes, applied to the body or to the details of the base, and accessible for the entire range of bathroom products, from the faucet to the bath, Industria leaves a wide space to personal inventiveness, allowing the creation of unique combinations, for an original and fresh product.

Di grande versatilità e gusto, la collezione INDUSTRIA congiunge forme più tradizionali e lineari al fascino delle zigrinature che ne impreziosiscono la figura. Presente in undici finiture differenti, applicabili al corpo e ai dettagli della base, e disponibile per l'intera gamma di prodotti per bagno, dal lavabo al bordo vasca, Industria lascia ampio spazio all'estro personale, permettendo di realizzare combinazioni irripetibili, per un prodotto sempre inedito.

De grande versatilité et goût, la collection INDUSTRIA associe des formes plutôt traditionnelles et linéaires au charme des crénelages qui embellissent la silhouette. Disponible en onze finitions différentes, applicables au corps et aux détails de la base, et disponible pour toute la gamme de produits, du lavabo à la baignoire, Industria laisse large place à la créativité personnelle, permettant la création de combinaisons uniques, pour un produit inédit.



KITCHEN
AVAILABLE



CUSTOMIZABLE
FINISHING



LEAD FREE



ZINC FREE







↑ ID200S_4
 Monohole washbasin mixer
 Miscelatore lavabo monoforo
 Mitigeur lavabo complet

↙ ID200CC_1
 Monohole washbasin mixer
 Miscelatore lavabo monoforo
 Mitigeur lavabo complet

→ ID200CS_1
 Monohole washbasin mixer
 Miscelatore lavabo monoforo
 Mitigeur lavabo complet

ID202SS_5
 Tall monohole washbasin mixer
 Miscelatore lavabo monoforo alto
 Mitigeur lavabo haut





BRUBINETTI



← ID200CC_1
Monohole washbasin mixer
Miscelatore lavabo monoforo
Mitigeur lavabo complet

↗ ID206CC_1
Wall mounted washbasin mixer
Miscelatore lavabo due fori a parete
Mitigeur lavabo mural

→ ID206CC_4
Wall mounted washbasin mixer
Miscelatore lavabo due fori a parete
Mitigeur lavabo mural







← ID200SS_14
Monohole washbasin mixer
Miscelatore lavabo monoforo
Mitigeur lavabo complet

↑ ID200CC_1
Monohole washbasin mixer
Miscelatore lavabo monoforo
Mitigeur lavabo complet

→ ID314CC_1

Three ways wall shower mixer with shower kit
Miscelatore doccia a parete con deviatore tre vie e doccino integrato
Mitigeur douche mural 3 voies avec inverseur et douchette encastrée

↓ ID392CC_1

Three holes washbasin set with low spout
Lavabo tre fori a bocca bassa
Lavabo trois trous bec bas







↑ ID313CC_1

Two ways wall shower mixer with shower kit
Miscelatore doccia a parete con deviatore due
vie e doccino integrato
Mitigeur douche mural deux voies avec
inverseur et douchette encastrée

→ ID80000_5

Shower column with mixer and shower kit
Colonna doccia con miscelatore e e kit doccia
Colonne de douche avec mitigeur et kit douche



ARTICLE | ARTICOLO | ARTICLE

ID200



Monohole washbasin mixer complete with drain

Miscelatore lavabo monoforo completo di scarico automatico

Mitigeur lavabo complet avec bonde automatique

CODE / COEFFICIENT | CODICE / COEFFICIENTE | CODE / COEFFICIENT

BODY | CORPO | CORPS

LEVER | LEVA | LEVIER



+



CC	ID200CC	6,2
SS	ID200SS	9,3
ON	ID200ON	6,2
NP	ID200NP	7,4
CF	ID200CF	9,3
CS	ID200CS	9,9
II	ID200II	9,3
IS	ID200IS	9,9
RS	ID200RS	9,3
SR	ID200SR	9,9
OO	ID200OO	9,3
OS	ID200OS	9,9



CC	_1	1,1
SS	_2	1,6
ON	_10	1,1
NP	_13	1,3
CF	_3	1,6
CS	_4	1,7
II	_8	1,6
IS	_9	1,7
RS	_7	1,6
SR	_14	1,7
OO	_5	1,6
OS	_11	1,7

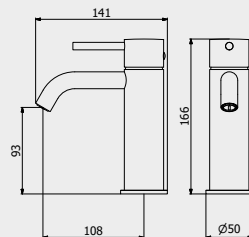

PORTATE | WATER FLOW | DÉBIT D'EAU

1 BAR	2 BAR	3 BAR
5,9 l/m	8,4 l/m	10,3 l/m

PACKAGING

L: 340 mm
D: 180 mm
H: 70 mm

1,6 kg

ARTICLE | ARTICOLO | ARTICLE

ID202



Tall monohole washbasin mixer complete with drain

Miscelatore lavabo monoforo alto completo di scarico automatico

Mitigeur lavabo haut complet avec bonde automatique

CODE / COEFFICIENT | CODICE / COEFFICIENTE | CODE / COEFFICIENT

BODY | CORPO | CORPS

LEVER | LEVA | LEVIER



+



CC	ID202CC	9,3
SS	ID202SS	14,0
ON	ID202ON	9,3
NP	ID202NP	11,2
CF	ID202CF	14,0
CS	ID202CS	14,9
II	ID202II	14,0
IS	ID202IS	14,9
RS	ID202RS	14,0
SR	ID202SR	14,9
OO	ID202OO	14,0
OS	ID202OS	14,9



CC	_1	1,1
SS	_2	1,6
ON	_10	1,1
NP	_13	1,3
CF	_3	1,6
CS	_4	1,7
II	_8	1,6
IS	_9	1,7
RS	_7	1,6
SR	_14	1,7
OO	_5	1,6
OS	_11	1,7

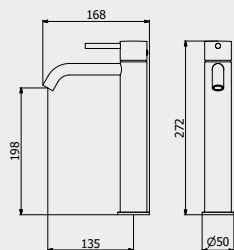

PORTATE | WATER FLOW | DÉBIT D'EAU

1 BAR	2 BAR	3 BAR
5,9 l/m	8,4 l/m	10,3 l/m

PACKAGING

L: 425 mm
D: 188 mm
H: 98 mm

2,3 kg

ARTICLE | ARTICOLO | ARTICLE

ID206



Wall mounted washbasin mixer complete with drain

Miscelatore lavabo due fori a parete completo di scarico automatico

Mitigeur lavabo mural complet avec bonde automatique

CODE / COEFFICIENT | CODICE / COEFFICIENTE | CODE / COEFFICIENT

BODY | CORPO | CORPS

LEVER | LEVA | LEVIER



+



CC	EID206CC	8,0
SS	EID206SS	12,0
ON	EID206ON	8,0
NP	EID206NP	9,6
CF	EID206CF	12,0
CS	EID206CS	12,8
II	EID206II	12,0
IS	EID206IS	12,8
RS	EID206RS	12,0
SR	EID206SR	12,8
OO	EID206OO	12,0
OS	EID206OS	12,8



CC	_1	0,8
SS	_2	1,2
ON	_10	0,8
NP	_13	1,0
CF	_3	1,2
CS	_4	1,3
II	_8	1,2
IS	_9	1,3
RS	_7	1,2
SR	_14	1,3
OO	_5	1,2
OS	_11	1,3

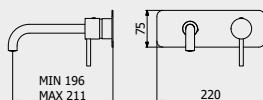

PORTATE | WATER FLOW | DÉBIT D'EAU

1 BAR	2 BAR	3 BAR
7,6 l/m	10,5 l/m	13 l/m

PACKAGING

L: 265 mm
D: 260 mm
H: 70 mm

1,3 kg

Built-in body to be purchased separately

Corpo incasso da acquistare separatamente

Corps intégré à acheter séparément



CODICE | CODE | CODE

INC206XXXN_19

COEFFICIENT | COEFFICIENTE | COEFFICIENT

2,9



ARTICLE | ARTICOLO | ARTICLE

ID207



Wall mounted washbasin mixer with long spout complete with drain
 Miscelatore lavabo 2 fori a parete con bocca lunga completo di scarico
 Mitigeur lavabo mural bec long complet avec bonde automatique

CODE / COEFFICIENT | CODICE / COEFFICIENTE | CODE / COEFFICIENT

BODY | CORPO | CORPS

LEVER | LEVA | LEVIER



	CC	EID207CC	8,4		CC	_1	0,8
	SS	EID207SS	12,6		SS	_2	1,2
	ON	EID207ON	8,4		ON	_10	0,8
	NP	EID207NP	10,1		NP	_13	1,0
	CF	EID207CF	12,6		CF	_3	1,2
	CS	EID207CS	13,4		CS	_4	1,3
	II	EID207II	12,6		II	_8	1,2
	IS	EID207IS	13,4		IS	_9	1,3
	RS	EID207RS	12,6		RS	_7	1,2
	SR	EID207SR	13,4		SR	_14	1,3
	OO	EID207OO	12,6		OO	_5	1,2
	OS	EID207OS	13,4		OS	_11	1,3

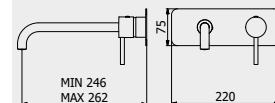

PORTATE | WATER FLOW | DÉBIT D'EAU

1 BAR	2 BAR	3 BAR
7,6 l/m	10,5 l/m	13 l/m

PACKAGING

	L: 265 mm		1,3 kg
	D: 260 mm		
	H: 70 mm		

Industria

Built-in body to be purchased separately

Corpo incasso da acquistare separatamente

Corps intégré à acheter séparément



CODICE | CODE | CODE

INC206XXXN_19

COEFFICIENT | COEFFICIENTE | COEFFICIENT

2,9



ARTICLE | ARTICOLO | ARTICLE

ID208



Wall mounted washbasin mixer with short spout complete with drain
 Miscelatore lavabo 2 fori a parete con bocca corta completo di scarico
 Mitigeur lavabo mural bec court complet avec bonde automatique

CODE / COEFFICIENT | CODICE / COEFFICIENTE | CODE / COEFFICIENT

BODY | CORPO | CORPS

LEVER | LEVA | LEVIER



	CC	EID208CC	8,4		CC	_1	0,8
	SS	EID208SS	12,6		SS	_2	1,2
	ON	EID208ON	8,4		ON	_10	0,8
	NP	EID208NP	10,1		NP	_13	1,0
	CF	EID208CF	12,6		CF	_3	1,2
	CS	EID208CS	13,4		CS	_4	1,3
	II	EID208II	12,6		II	_8	1,2
	IS	EID208IS	13,4		IS	_9	1,3
	RS	EID208RS	12,6		RS	_7	1,2
	SR	EID208SR	13,4		SR	_14	1,3
	OO	EID208OO	12,6		OO	_5	1,2
	OS	EID208OS	13,4		OS	_11	1,3

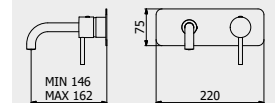

PORTATE | WATER FLOW | DÉBIT D'EAU

1 BAR	2 BAR	3 BAR
7,6 l/m	10,5 l/m	13 l/m

PACKAGING

	L: 265 mm		1,3 kg
	D: 260 mm		
	H: 70 mm		

Built-in body to be purchased separately

Corpo incasso da acquistare separatamente

Corps intégré à acheter séparément



CODICE | CODE | CODE

INC206XXXN_19

COEFFICIENT | COEFFICIENTE | COEFFICIENT

2,9



ARTICLE | ARTICOLO | ARTICLE

ID210



Ceiling spout with wall mounted mixer

Bocca da soffitto con comando remoto ad incasso

Mitigeur lavabo mural avec bec plafond complet avec bonde automatique

CODE / COEFFICIENT | CODICE / COEFFICIENTE | CODE / COEFFICIENT

BODY | CORPO | CORPS

LEVER | LEVA | LEVIER

● CC	EID210CC	25,0	● CC	_1	0,9
● SS	EID210SS	37,5	● SS	_2	1,4
● ON	EID210ON	25,0	● ON	_10	0,9
● NP	EID210NP	30,0	● NP	_13	1,1
● CF	EID210CF	37,5	● CF	_3	1,4
● CS	EID210CS	40,0	● CS	_4	1,5
● II	EID210II	37,5	● II	_8	1,4
● IS	EID210IS	40,0	● IS	_9	1,5
● RS	EID210RS	37,5	● RS	_7	1,4
● SR	EID210SR	40,0	● SR	_14	1,5
● OO	EID210OO	37,5	● OO	_5	1,4
● OS	EID210OS	40,0	● OS	_11	1,5

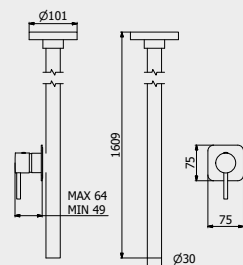

PORTATE | WATER FLOW | DÉBIT D'EAU

1 BAR	2 BAR	3 BAR
4,3 l/m	5,2 l/m	6,9 l/m

PACKAGING

L: 150 mm
D: 190 mm
H: 98 mm

L: 1700 mm
Ø: 70 mm
4,5 kg

Built-in body to be purchased separately

Corpo incasso da acquistare separatamente

Corps intégré à acheter séparément



CODICE | CODE | CODE

INC300XXXN_19

COEFFICIENT | COEFFICIENTE | COEFFICIENT

1,8



ARTICLE | ARTICOLO | ARTICLE

ID299



Monohole free-standing washbasin mixer complete with drain

Miscelatore lavabo da terra completo di scarico automatico

Mitigeur Lavabo Free standing complet avec bonde automatique

CODE / COEFFICIENT | CODICE / COEFFICIENTE | CODE / COEFFICIENT

BODY | CORPO | CORPS

LEVER | LEVA | LEVIER

● CC	EID299CC	28,3	● CC	_1	1,1
● SS	EID299SS	42,4	● SS	_2	1,6
● ON	EID299ON	28,3	● ON	_10	1,1
● NP	EID299NP	33,9	● NP	_13	1,3
● CF	EID299CF	42,4	● CF	_3	1,6
● CS	EID299CS	45,2	● CS	_4	1,7
● II	EID299II	42,4	● II	_8	1,6
● IS	EID299IS	45,2	● IS	_9	1,7
● RS	EID299RS	42,4	● RS	_7	1,6
● SR	EID299SR	45,2	● SR	_14	1,7
● OO	EID299OO	42,4	● OO	_5	1,6
● OS	EID299OS	45,2	● OS	_11	1,7

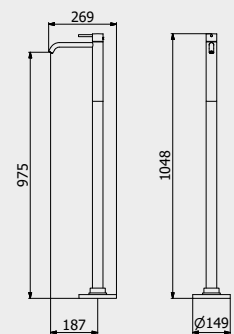

PORTATE | WATER FLOW | DÉBIT D'EAU

1 BAR	2 BAR	3 BAR
5,5 l/m	7,8 l/m	9,6 l/m

PACKAGING

L: 1100 mm
D: 395 mm
H: 150 mm

15,6 kg

Built-in body to be purchased separately
AVAILABLE FROM JANUARY 2020Corpo incasso da acquistare separatamente
DISPONIBILE DA GENNAIO 2020Corps intégré à acheter séparément
DISPONIBLE À PARTIR DE JANVIER 2020

CODICE | CODE | CODE

INC399XXXN_19

COEFFICIENT | COEFFICIENTE | COEFFICIENT

2,8

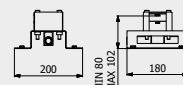

ARTICLE | ARTICOLO | ARTICLE

ID392



Three holes washbasin set with low spout

Lavabo tre fori a bocca bassa completo di scarico automatico

Lavabo trois trous bec bas

CODE / COEFFICIENT | CODICE / COEFFICIENTE | CODE / COEFFICIENT

BODY | CORPO | CORPS

LEVER | LEVA | LEVIER



	CC	ID392CC	10,6		CC	_1	1,9
	SS	ID392SS	15,9		SS	_2	2,9
	ON	ID392ON	10,6		ON	_10	1,9
	NP	ID392NP	12,8		NP	_13	2,3
	CF	ID392CF	15,9		CF	_3	2,9
	CS	ID392CS	17,0		CS	_4	3,1
	II	ID392II	15,9		II	_8	2,9
	IS	ID392IS	17,0		IS	_9	3,1
	RS	ID392RS	15,9		RS	_7	2,9
	SR	ID392SR	17,0		SR	_14	3,1
	OO	ID392OO	15,9		OO	_5	2,9
	OS	ID392OS	17,0		OS	_11	3,1

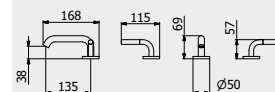

PORTATE | WATER FLOW | DÉBIT D'EAU

1 BAR	2 BAR	3 BAR
5,5 l/m	6 l/m	6 l/m

PACKAGING

	L: 370 mm		3 kg
	D: 270 mm		
	H: 80 mm		

Industria

ARTICLE | ARTICOLO | ARTICLE

ID394



Two pieces washbasin mixer

Miscelatore lavabo due fori

Mitigeur lavabo deux piece

CODE / COEFFICIENT | CODICE / COEFFICIENTE | CODE / COEFFICIENT

BODY | CORPO | CORPS

LEVER | LEVA | LEVIER



	CC	ID394CC	8,0		CC	_1	1,5
	SS	ID394SS	12,0		SS	_2	2,3
	ON	ID394ON	8,0		ON	_10	1,5
	NP	ID394NP	9,6		NP	_13	1,8
	CF	ID394CF	12,0		CF	_3	2,3
	CS	ID394CS	12,8		CS	_4	2,4
	II	ID394II	12,0		II	_8	2,3
	IS	ID394IS	12,8		IS	_9	2,4
	RS	ID394RS	12,0		RS	_7	2,3
	SR	ID394SR	12,8		SR	_14	2,4
	OO	ID394OO	12,0		OO	_5	2,3
	OS	ID394OS	12,8		OS	_11	2,4

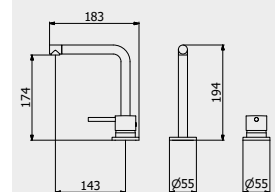

PORTATE | WATER FLOW | DÉBIT D'EAU

1 BAR	2 BAR	3 BAR
4,5 l/m	5 l/m	5 l/m

PACKAGING

	L: 360 mm		2,3 kg
	D: 220 mm		
	H: 150 mm		

ARTICLE | ARTICOLO | ARTICLE

ID220



Monohole bidet mixer complete with drain

Miscelatore bidet monoforo completo di scarico automatico

Mitigeur bidet complet avec bonde automatique

CODE / COEFFICIENT | CODICE / COEFFICIENTE | CODE / COEFFICIENT

BODY | CORPO | CORPS

LEVER | LEVA | LEVIER



	CC	ID220CC	6,2		CC	_1	1,1
	SS	ID220SS	9,3		SS	_2	1,6
	ON	ID220ON	6,2		ON	_10	1,1
	NP	ID220NP	7,4		NP	_13	1,3
	CF	ID220CF	9,3		CF	_3	1,6
	CS	ID220CS	9,9		CS	_4	1,7
	II	ID220II	9,3		II	_8	1,6
	IS	ID220IS	9,9		IS	_9	1,7
	RS	ID220RS	9,3		RS	_7	1,6
	SR	ID220SR	9,9		SR	_14	1,7
	OO	ID220OO	9,3		OO	_5	1,6
	OS	ID220OS	9,9		OS	_11	1,7

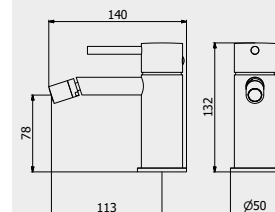

PORTATE | WATER FLOW | DÉBIT D'EAU

1 BAR	2 BAR	3 BAR
5,9 l/m	8,4 l/m	10,3 l/m

PACKAGING

	L: 340 mm		1,6 kg
	D: 180 mm		
	H: 70 mm		

ARTICLE | ARTICOLO | ARTICLE

ID300



Exposed parts for manual wall mixer

Set di parti esterne per miscelatore a parete ad una via

Partie extérieure pour mitigeur encastré à une voie

CODE / COEFFICIENT | CODICE / COEFFICIENTE | CODE / COEFFICIENT

BODY | CORPO | CORPS

LEVER | LEVA | LEVIER



+



CC	EID300CC	3,0
SS	EID300SS	4,5
ON	EID300ON	3,0
NP	EID300NP	3,6
CF	EID300CF	4,5
CS	EID300CS	4,8
II	EID300II	4,5
IS	EID300IS	4,8
RS	EID300RS	4,5
SR	EID300SR	4,8
OO	EID300OO	4,5
OS	EID300OS	4,8



CC	_1	1,1
SS	_2	1,7
ON	_10	1,1
NP	_13	1,3
CF	_3	1,7
CS	_4	1,8
II	_8	1,7
IS	_9	1,8
RS	_7	1,7
SR	_14	1,8
OO	_5	1,7
OS	_11	1,8

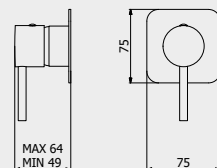

PORTATE | WATER FLOW | DÉBIT D'EAU

1 BAR	2 BAR	3 BAR
11,5 l/m	16,3 l/m	20 l/m

PACKAGING

L: 150 mm
D: 190 mm
H: 98 mm

1,4 kg

Built-in body to be purchased separately

Corpo incasso da acquistare separatamente

Corps intégré à acheter séparément



CODICE | CODE | CODE

INC300XXXN_19

COEFFICIENT | COEFFICIENTE | COEFFICIENT

1,8

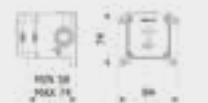

ARTICLE | ARTICOLO | ARTICLE

ID310



Exposed parts for manual wall mixer with two ways diverter

Miscelatore doccia a parete con deviatore due vie

Mitigeur douche mural deux voies avec inverseur

CODE / COEFFICIENT | CODICE / COEFFICIENTE | CODE / COEFFICIENT

BODY | CORPO | CORPS

LEVER | LEVA | LEVIER



+



CC	EID310CC	4,3
SS	EID310SS	6,5
ON	EID310ON	4,3
NP	EID310NP	5,2
CF	EID310CF	6,5
CS	EID310CS	6,9
II	EID310II	6,5
IS	EID310IS	6,9
RS	EID310RS	6,5
SR	EID310SR	6,9
OO	EID310OO	6,5
OS	EID310OS	6,9



CC	_1	1,8
SS	_2	2,7
ON	_10	1,8
NP	_13	2,2
CF	_3	2,7
CS	_4	2,9
II	_8	2,7
IS	_9	2,9
RS	_7	2,7
SR	_14	2,9
OO	_5	2,7
OS	_11	2,9

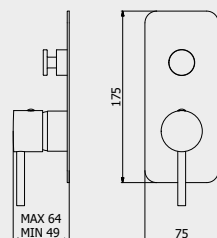

PORTATE | WATER FLOW | DÉBIT D'EAU

1 BAR	2 BAR	3 BAR
9,2 l/m	12,8 l/m	16 l/m

PACKAGING

L: 150 mm
D: 190 mm
H: 98 mm

1,4 kg

Built-in body to be purchased separately

Corpo incasso da acquistare separatamente

Corps intégré à acheter séparément



CODICE | CODE | CODE

INC310XXXN_19

COEFFICIENT | COEFFICIENTE | COEFFICIENT

3,3



ARTICLE | ARTICOLO | ARTICLE

ID312



Exposed parts for manual wall mixer with three ways diverter
Set di parti esterne per miscelatore a parete a tre vie
Mitigeur douche mural trois voies avec inverseur

CODE / COEFFICIENT | CODICE / COEFFICIENTE | CODE / COEFFICIENT

BODY | CORPO | CORPS

LEVER | LEVA | LEVIER



+



CC	EID312CC	5,6
SS	EID312SS	8,4
ON	EID312ON	5,6
NP	EID312NP	6,7
CF	EID312CF	8,4
CS	EID312CS	9,0
II	EID312II	8,4
IS	EID312IS	9,0
RS	EID312RS	8,4
SR	EID312SR	9,0
OO	EID312OO	8,4
OS	EID312OS	9,0

CC	_1	1,8
SS	_2	2,7
ON	_10	1,8
NP	_13	2,2
CF	_3	2,7
CS	_4	2,9
II	_8	2,7
IS	_9	2,9
RS	_7	2,9
SR	_14	2,9
OO	_5	2,7
OS	_11	2,9

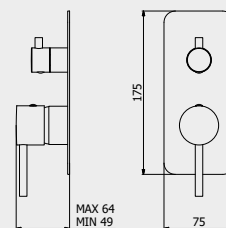

PORTATE | WATER FLOW | DÉBIT D'EAU

1 BAR	2 BAR	3 BAR
8,3 l/m	11,7 l/m	14,3 l/m

PACKAGING

L: 150 mm
D: 190 mm
H: 98 mm

1,4 kg

Industria

Built-in body to be purchased separately

Corpo incasso da acquistare separatamente

Corps intégré à acheter séparément



CODICE | CODE | CODE

INC312XXXN_19

COEFFICIENT | COEFFICIENTE | COEFFICIENT

3,3

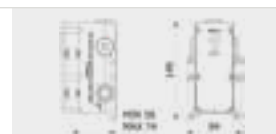

ARTICLE | ARTICOLO | ARTICLE

ID313



Two ways wall shower mixer complete with shower kit

Miscelatore doccia a parete con deviatore due vie e doccino integrato
Mitigeur douche mural 2 voies avec inverseur et douchette encastrée

CODE / COEFFICIENT | CODICE / COEFFICIENTE | CODE / COEFFICIENT

BODY | CORPO | CORPS

LEVER | LEVA | LEVIER



+



CC	EID313CC	6,6
SS	EID313SS	9,9
ON	EID313ON	6,6
NP	EID313NP	7,9
CF	EID313CF	9,9
CS	EID313CS	10,6
II	EID313II	9,9
IS	EID313IS	10,6
RS	EID313RS	9,9
SR	EID313SR	10,6
OO	EID313OO	9,9
OS	EID313OS	10,6

CC	_1	3,8
SS	_2	5,7
ON	_10	3,8
NP	_13	4,6
CF	_3	5,7
CS	_4	6,1
II	_8	5,7
IS	_9	6,1
RS	_7	5,7
SR	_14	6,1
OO	_5	5,7
OS	_11	6,1

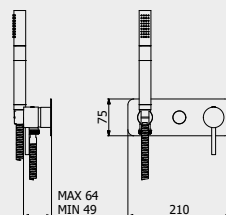

PORTATE | WATER FLOW | DÉBIT D'EAU

1 BAR	2 BAR	3 BAR
10 l/m	14,1 l/m	17,2 l/m

PACKAGING

L: 370 mm
D: 270 mm
H: 80 mm

2,2 kg

Built-in body to be purchased separately

Corpo incasso da acquistare separatamente

Corps intégré à acheter séparément



CODICE | CODE | CODE

INC313XXXN_19

COEFFICIENT | COEFFICIENTE | COEFFICIENT

3,6



ARTICLE | ARTICOLO | ARTICLE

ID314



Three ways wall shower mixer complete with shower kit

Miscelatore doccia a parete con deviatore tre vie e doccia integrato

Mitigeur douche mural 3 voies avec inverseur et douchette encastrée

CODE / COEFFICIENT | CODICE / COEFFICIENTE | CODE / COEFFICIENT

BODY | CORPO | CORPS

LEVER | LEVA | LEVIER

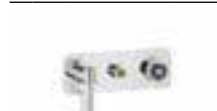

+



CC	EID314CC	8,0
SS	EID314SS	12,0
ON	EID314ON	8,0
NP	EID314NP	9,6
CF	EID314CF	12,0
CS	EID314CS	12,8
II	EID314II	12,0
IS	EID314IS	12,8
RS	EID314RS	12,0
SR	EID314SR	12,8
OO	EID314OO	12,0
OS	EID314OS	12,8



CC	_1	3,8
SS	_2	5,7
ON	_10	3,8
NP	_13	4,6
CF	_3	5,7
CS	_4	6,1
II	_8	5,7
IS	_9	6,1
RS	_7	5,7
SR	_14	6,1
OO	_5	5,7
OS	_11	6,1

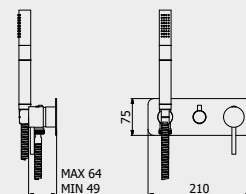

PORTATE | WATER FLOW | DÉBIT D'EAU

1 BAR	2 BAR	3 BAR
8,3 l/m	11,7 l/m	14,3 l/m

PACKAGING

L: 370 mm
D: 270 mm
H: 80 mm

2,2 kg

Built-in body to be purchased separately

Corpo incasso da acquistare separatamente

Corps intégré à acheter séparément



CODICE | CODE | CODE

INC314XXXN_19

COEFFICIENT | COEFFICIENTE | COEFFICIENT

3,7



ARTICLE | ARTICOLO | ARTICLE

ID350



Wall mounted shower mixer with shower kit

Doccia esterno a parete completo di kit doccia

Mitigeur de douche externe avec flexible et douchette

CODE / COEFFICIENT | CODICE / COEFFICIENTE | CODE / COEFFICIENT

BODY | CORPO | CORPS

LEVER | LEVA | LEVIER



+



CC	ID350CC	9,7
SS	ID350SS	14,5
ON	ID350ON	9,7
NP	ID350NP	11,6
CF	ID350CF	14,5
CS	ID350CS	15,5
II	ID350II	14,5
IS	ID350IS	15,5
RS	ID350RS	14,5
SR	ID350SR	15,5
OO	ID350OO	14,5
OS	ID350OS	15,5



CC	_1	3,9
SS	_2	5,9
ON	_10	3,9
NP	_13	4,7
CF	_3	5,9
CS	_4	6,3
II	_8	5,9
IS	_9	6,3
RS	_7	5,9
SR	_14	6,3
OO	_5	5,9
OS	_11	6,3

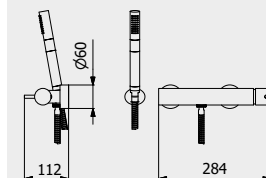

PORTATE | WATER FLOW | DÉBIT D'EAU

1 BAR	2 BAR	3 BAR
12,5 l/m	17,5 l/m	21 l/m

PACKAGING

L: 370 mm
D: 270 mm
H: 80 mm

3,9 kg

ARTICLE | ARTICOLO | ARTICLE

ID250



Wall mounted bath filler complete with hand shower kit

Bordo vasca esterno a parete completo di kit doccia

Mitigeur Bain mural avec douchette encastrée

CODE / COEFFICIENT | CODICE / COEFFICIENTE | CODE / COEFFICIENT

BODY | CORPO | CORPS

LEVER | LEVA | LEVIER



+



CC	ID250CC	11,0
SS	ID250SS	16,5
ON	ID250ON	11,0
NP	ID250NP	13,2
CF	ID250CF	16,5
CS	ID250CS	17,6
II	ID250II	16,5
IS	ID250IS	17,6
RS	ID250RS	16,5
SR	ID250SR	17,6
OO	ID250OO	16,5
OS	ID250OS	17,6



CC	_1	3,9
SS	_2	5,9
ON	_10	3,9
NP	_13	4,7
CF	_3	5,9
CS	_4	6,3
II	_8	5,9
IS	_9	6,3
RS	_7	5,9
SR	_14	6,3
OO	_5	5,9
OS	_11	6,3

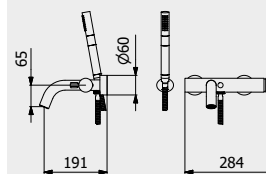

PORTATE | WATER FLOW | DÉBIT D'EAU

1 BAR	2 BAR	3 BAR
10 l/m	14,3 l/m	18 l/m

PACKAGING

L: 370 mm
D: 270 mm
H: 80 mm

4,2 kg



ARTICLE | ARTICOLO | ARTICLE

ID396



Four holes deck mounted bath filler with shower kit
Bordo vasca quattro fori con deviatore e kit doccia
Bain quatre trous avec inverseur et Kit Douche

CODE / COEFFICIENT | CODICE / COEFFICIENTE | CODE / COEFFICIENT

BODY | CORPO | CORPS

LEVER | LEVA | LEVIER



	CC	ID396CC	12,6		CC	_1	6,0
	SS	ID396SS	18,8		SS	_2	8,9
	ON	ID396ON	12,6		ON	_10	6,0
	NP	ID396NP	15,1		NP	_13	7,1
	CF	ID396CF	18,8		CF	_3	8,9
	CS	ID396CS	20,1		CS	_4	9,5
	II	ID396II	18,8		II	_8	8,9
	IS	ID396IS	20,1		IS	_9	9,5
	RS	ID396RS	18,8		RS	_7	8,9
	SR	ID396SR	20,1		SR	_14	9,5
	OO	ID396OO	18,8		OO	_5	8,9
	OS	ID396OS	20,1		OS	_11	9,5

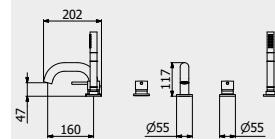

PORTATE | WATER FLOW | DÉBIT D'EAU

1 BAR	2 BAR	3 BAR
9,3 l/m	13,2 l/m	16,2 l/m

PACKAGING

	L: 400 mm		4 kg
	D: 250 mm		
	H: 140 mm		

Industria

ARTICLE | ARTICOLO | ARTICLE

ID397



3 holes bath filler with overflow outlet connection, diverter and shower kit
Bordo vasca tre fori per colonna riempimento con deviatore e kit doccia
Bain trois trous avec inverseur et Kit Douche pour remplissage ETP

CODE / COEFFICIENT | CODICE / COEFFICIENTE | CODE / COEFFICIENT

BODY | CORPO | CORPS

LEVER | LEVA | LEVIER



	CC	ID397CC	12,6		CC	_1	4,7
	SS	ID397SS	18,8		SS	_2	7,0
	ON	ID397ON	12,6		ON	_10	4,7
	NP	ID397ONP	15,1		NP	_13	5,6
	CF	ID397CF	18,8		CF	_3	7,0
	CS	ID397CS	20,1		CS	_4	7,5
	II	ID397II	18,8		II	_8	7,0
	IS	ID397IS	20,1		IS	_9	7,5
	RS	ID397RS	18,8		RS	_7	7,0
	SR	ID397SR	20,1		SR	_14	7,5
	OO	ID397OO	18,8		OO	_5	7,0
	OS	ID397OS	20,1		OS	_11	7,5

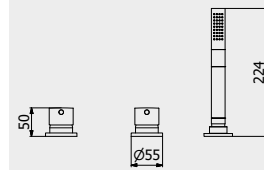

PORTATE | WATER FLOW | DÉBIT D'EAU

1 BAR	2 BAR	3 BAR
12 l/m	17 l/m	22 l/m

PACKAGING

	L: 370 mm		3,2 kg
	D: 270 mm		
	H: 80 mm		

ARTICLE | ARTICOLO | ARTICLE

ID398



Two ways wall shower mixer with spout
Miscelatore doccia a parete con bocca
Mitigeur douche mural avec bec

CODE / COEFFICIENT | CODICE / COEFFICIENTE | CODE / COEFFICIENT

BODY | CORPO | CORPS

LEVER | LEVA | LEVIER



	CC	EID398CC	9,3		CC	_1	4,2
	SS	EID398SS	13,9		SS	_2	6,3
	ON	EID398ON	9,3		ON	_10	4,2
	NP	EID398ONP	11,1		NP	_13	5,1
	CF	EID398CF	13,9		CF	_3	6,3
	CS	EID398CS	14,8		CS	_4	6,8
	II	EID398II	13,9		II	_8	6,3
	IS	EID398IS	14,8		IS	_9	6,8
	RS	EID398RS	13,9		RS	_7	6,3
	SR	EID398SR	14,8		SR	_14	6,8
	OO	EID398OO	13,9		OO	_5	6,3
	OS	EID398OS	14,8		OS	_11	6,8

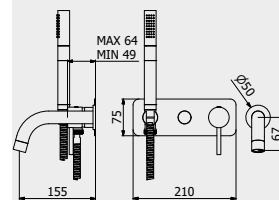

PORTATE | WATER FLOW | DÉBIT D'EAU

10 l/m	14,1 l/m	17,2 l/m
--------	----------	----------

PACKAGING

	L: 470 mm		4,8 kg
	D: 290 mm		
	H: 160 mm		

Built-in body to be purchased separately

Corpo incasso da acquistare separatamente

Corps intégré à acheter séparément



CODICE | CODE | CODE

INC313XXN_19

COEFFICIENT | COEFFICIENTE | COEFFICIENT

3,6

ARTICLE | ARTICOLO | ARTICLE

ID399



Floormount tub filler with hand shower

Bordo vasca da pavimento con doccia

Robinet de bain au sol avec douchette

CODE / COEFFICIENT | CODICE / COEFFICIENTE | CODE / COEFFICIENT

BODY | CORPO | CORPS

LEVER | LEVA | LEVIER



+



● CC	EID399CC	28,5
● SS	EID399SS	42,8
● ON	EID399ON	28,5
● NP	EID399ONP	34,2
● CF	EID399CF	42,8
● CS	EID399CS	45,6
● II	EID399II	42,8
● IS	EID399IS	45,6
● RS	EID399RS	42,8
● SR	EID399SR	45,6
● OO	EID399OO	42,8
● OS	EID399OS	45,6



● CC	_1	2,9
● SS	_2	4,3
● ON	_10	2,9
● NP	_13	3,5
● CF	_3	4,3
● CS	_4	4,6
● II	_8	4,3
● IS	_9	4,6
● RS	_7	4,3
● SR	_14	4,6
● OO	_5	4,3
● OS	_11	4,6

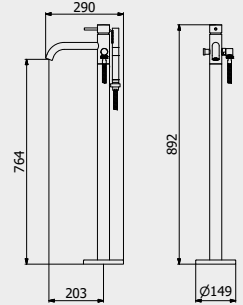

PORTATE | WATER FLOW | DÉBIT D'EAU

1 BAR	2 BAR	3 BAR
11,2 l/m	16 l/m	19,5 l/m

PACKAGING

L: 1100 mm	15,6 kg
D: 395 mm	
H: 150 mm	

Built-in body to be purchased separately
AVAILABLE FROM JANUARY 2020Corpo incasso da acquistare separatamente
DISPONIBILE DA GENNAIO 2020Corps intégré à acheter séparément
DISPONIBLE À PARTIR DE JANVIER 2020

CODICE | CODE | CODE

INC399XXXN_19

COEFFICIENT | COEFFICIENTE | COEFFICIENT

2,8

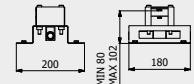

ARTICLE | ARTICOLO | ARTICLE

ID800



Industria thermostatic shower column with shower kit

Colonna doccia Industria termostatica con kit doccia

Industria colonne de douche thermostatique avec kit douche

CODE / COEFFICIENT | CODICE / COEFFICIENTE | CODE / COEFFICIENT

BODY | CORPO | CORPS

LEVER | LEVA | LEVIER



+



● CC	ID800CC	30,8
● SS	ID800SS	46,1
● ON	ID800ON	30,8
● NP	ID800ONP	36,9
● CF	ID800CF	46,1
● CS	ID800CS	49,2
● II	ID800II	46,1
● IS	ID800IS	49,2
● RS	ID800RS	46,1
● SR	ID800SR	49,2
● OO	ID800OO	46,1
● OS	ID800OS	49,2



● CC	_1	5,4
● SS	_2	8,1
● ON	_10	5,4
● NP	_13	6,5
● CF	_3	8,1
● CS	_4	8,6
● II	_8	8,1
● IS	_9	8,6
● RS	_7	8,1
● SR	_14	8,6
● OO	_5	8,1
● OS	_11	8,6

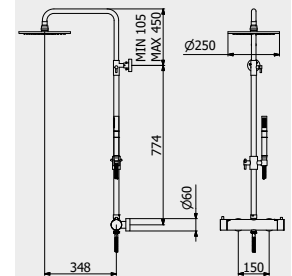

PORTATE | WATER FLOW | DÉBIT D'EAU

1 BAR	2 BAR	3 BAR
7,8 l/m	11,1 l/m	12,5 l/m

PACKAGING

L: 1020 mm	3,4 kg
D: 490 mm	
H: 120 mm	



ARTICLE | ARTICOLO | ARTICLE

ID320



Wall mounted spout
Bocca d'erogazione a parete
Bec de remplissage mural

CODE / COEFFICIENT | CODICE / COEFFICIENTE | CODE / COEFFICIENT

BODY | CORPO | CORPS

LEVER | LEVA | LEVIER



	CC	ID320CC	2,3		CC	_1	0,5
	SS	ID320SS	3,5		SS	_2	0,8
	ON	ID320ON	2,3		ON	_10	0,5
	NP	ID320NP	2,8		NP	_13	0,6
	CF	ID320CF	3,5		CF	_3	0,8
	CS	ID320CS	3,7		CS	_4	0,8
	II	ID320II	3,5		II	_8	0,8
	IS	ID320IS	3,7		IS	_9	0,8
	RS	ID320RS	3,5		RS	_7	0,8
	SR	ID320SR	3,7		SR	_14	0,8
	OO	ID320OO	3,5		OO	_5	0,8
	OS	ID320OS	3,7		OS	_11	0,8

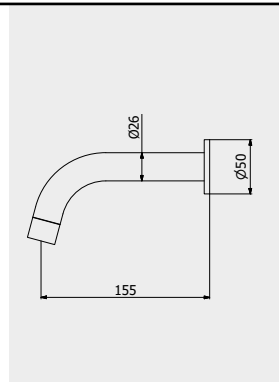

PORTATE | WATER FLOW | DÉBIT D'EAU

1 BAR	2 BAR	3 BAR
6,5 l/m	8 l/m	8 l/m

PACKAGING

L: 150 mm
D: 190 mm
H: 98 mm

0,24 kg

Industria

ARTICLE | ARTICOLO | ARTICLE

ID321



Short wall mounted spout
Bocca d'erogazione corta a parete
Bec de remplissage mural court

CODE / COEFFICIENT | CODICE / COEFFICIENTE | CODE / COEFFICIENT

BODY | CORPO | CORPS

LEVER | LEVA | LEVIER



	CC	ID321CC	2,5		CC	_1	0,5
	SS	ID321SS	3,7		SS	_2	0,8
	ON	ID321ON	2,5		ON	_10	0,5
	NP	ID321NP	2,9		NP	_13	0,6
	CF	ID321CF	3,7		CF	_3	0,8
	CS	ID321CS	3,9		CS	_4	0,8
	II	ID321II	3,7		II	_8	0,8
	IS	ID321IS	3,9		IS	_9	0,8
	RS	ID321RS	3,7		RS	_7	0,8
	SR	ID321SR	3,9		SR	_14	0,8
	OO	ID321OO	3,7		OO	_5	0,8
	OS	ID321OS	3,9		OS	_11	0,8

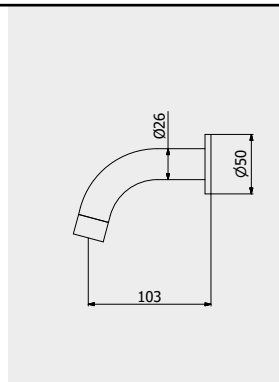

PORTATE | WATER FLOW | DÉBIT D'EAU

1 BAR	2 BAR	3 BAR
6,5 l/m	8 l/m	8 l/m

PACKAGING

L: 150 mm
D: 190 mm
H: 98 mm

0,23 kg

ARTICLE | ARTICOLO | ARTICLE

ID322



Long wall mounted spout
Bocca d'erogazione lunga a parete
Bec de remplissage mural long

CODE / COEFFICIENT | CODICE / COEFFICIENTE | CODE / COEFFICIENT

BODY | CORPO | CORPS

LEVER | LEVA | LEVIER



	CC	ID322CC	2,5		CC	_1	0,5
	SS	ID322SS	3,7		SS	_2	0,8
	ON	ID322ON	2,5		ON	_10	0,5
	NP	ID322NP	2,9		NP	_13	0,6
	CF	ID322CF	3,7		CF	_3	0,8
	CS	ID322CS	3,9		CS	_4	0,8
	II	ID322II	3,7		II	_8	0,8
	IS	ID322IS	3,9		IS	_9	0,8
	RS	ID322RS	3,7		RS	_7	0,8
	SR	ID322SR	3,9		SR	_14	0,8
	OO	ID322OO	3,7		OO	_5	0,8
	OS	ID322OS	3,9		OS	_11	0,8

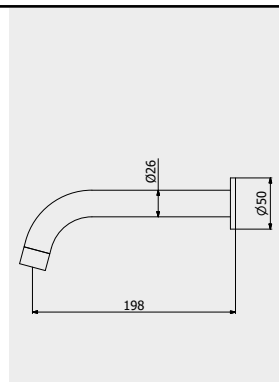

PORTATE | WATER FLOW | DÉBIT D'EAU

1 BAR	2 BAR	3 BAR
6,5 l/m	8 l/m	8 l/m

PACKAGING

L: 150 mm
D: 190 mm
H: 98 mm

0,25 kg

ARTICLE | ARTICOLO | ARTICLE

B2022



Duplex

Duplex

Duplex

CODE / COEFFICIENT | CODICE / COEFFICIENTE | CODE / COEFFICIENT

● CC	B2022CC	6,3
● SS	B2022SS	7,9
● ON	B2022ON	6,3
● NP	B2022NP	7,9
● CF	B2022CF	9,5
● CS	B2022CS	10,1
● II	B2022II	9,5
● IS	B2022IS	10,1
● RS	B2022RS	9,5
● SR	B2022SR	10,1
● OO	B2022OO	9,5
● OS	B2022OS	10,1

PACKAGING

 L: 340 mm
D: 180 mm
H: 70 mm

1,0 kg

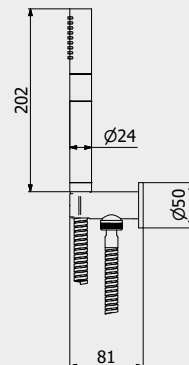

ARTICLE | ARTICOLO | ARTICLE

ID706



Exposed parts for bidet spray complete with mixer

Set di parti esterne per Idroscopino igienico con miscelatore

Partie extérieure pour douchette hygiénique avec mitigeur

CODE / COEFFICIENT | CODICE / COEFFICIENTE | CODE / COEFFICIENT

BODY | CORPO | CORPS

LEVER | LEVA | LEVIER



+



● CC	ID706CC	6,1
● SS	ID706SS	9,2
● ON	ID706ON	6,1
● NP	ID706NP	7,3
● CF	ID706CF	9,2
● CS	ID706CS	9,8
● II	ID706II	9,2
● IS	ID706IS	9,8
● RS	ID706RS	9,2
● SR	ID706SR	9,8
● OO	ID706OO	9,2
● OS	ID706OS	9,8
● CC	_1	3,8
● SS	_2	5,7
● ON	_10	3,8
● NP	_13	4,6
● CF	_3	5,7
● CS	_4	6,1
● II	_8	5,7
● IS	_9	6,1
● RS	_7	5,7
● SR	_14	6,1
● OO	_5	5,7
● OS	_11	6,1

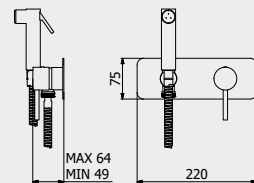

PORTATE | WATER FLOW | DÉBIT D'EAU

1 BAR	2 BAR	3 BAR
2,3 l/m	3,2 l/m	4 l/m

PACKAGING

 L: 370 mm
D: 270 mm
H: 80 mm

3,1 kg

Built-in body to be purchased separately

Corpo incasso da acquistare separatamente

Corps intégré à acheter séparément



CODICE | CODE | CODE

INC206XXXN_19

COEFFICIENT | COEFFICIENTE | COEFFICIENT

2,9



ARTICLE | ARTICOLO | ARTICLE

ID370



Single Lever kitchen mixer

Miscelatore lavello monoforo

Évier de cuisine

CODE / COEFFICIENT | CODICE / COEFFICIENTE | CODE / COEFFICIENT

BODY | CORPO | CORPS

LEVER | LEVA | LEVIER



+



● CC	ID370CC	9,3
● SS	ID370SS	14,0
● ON	ID370ON	9,3
● NP	ID370ONP	11,2
● CF	ID370CF	14,0
● CS	ID370CS	14,9
● II	ID370II	14,0
● IS	ID370IS	14,9
● RS	ID370RS	14,0
● SR	ID370SR	14,9
● OO	ID370OO	14,0
● OS	ID370OS	14,9
● CC	_1	1,1
● SS	_2	1,7
● ON	_10	1,1
● NP	_13	1,4
● CF	_3	1,7
● CS	_4	1,8
● II	_8	1,7
● IS	_9	1,8
● RS	_7	1,7
● SR	_14	1,8
● OO	_5	1,7
● OS	_11	1,8

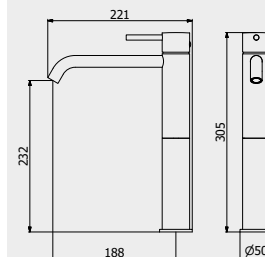

PORTATE | WATER FLOW | DÉBIT D'EAU

1 BAR	2 BAR	3 BAR
5,5 l/m	7,5 l/m	9,1 l/m

PACKAGING

 L: 455 mm
D: 310 mm
H: 75 mm

2,7 kg



OFFICINA / ACCESSORIES COLLECTION

Industria



ARTICLE | ARTICOLO | ARTICLE

OF006



PACKAGING

L: 330 mm
D: 90 mm
H: 40 mm

0,15 kg

Towel holder
Porta salvietta
Porte-serviette

CODE / COEFFICIENT | CODICE /
COEFFICIENTE | CODE / COEFFICIENT

CC	OF006CC	2,4
SS	OF006SS	3,0
ON	OF006ON	2,4
BO	OF006BO	2,9
NP	OF006NP	2,9
CF	OF006CF	3,6
CS	OF006CS	3,8
II	OF006II	3,6
IS	OF006IS	3,8
RS	OF006RS	3,6
SR	OF006SR	3,8
OO	OF006OO	3,6
OS	OF006OS	3,8

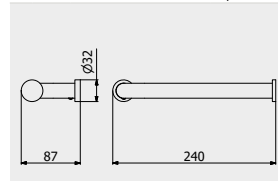

ARTICLE | ARTICOLO | ARTICLE

OF011



PACKAGING

L: 410 mm
D: 195 mm
H: 100 mm

0,3 kg

Toilet paper holder
Porta rotolo
Porte rouleaux de toilette

CODE / COEFFICIENT | CODICE /
COEFFICIENTE | CODE / COEFFICIENT

CC	OF011CC	2,1
SS	OF011SS	2,6
ON	OF011ON	2,1
BO	OF011BO	2,6
NP	OF011NP	2,6
CF	OF011CF	3,2
CS	OF011CS	3,4
II	OF011II	3,2
IS	OF011IS	3,4
RS	OF011RS	3,2
SR	OF011SR	3,4
OO	OF011OO	3,2
OS	OF011OS	3,4

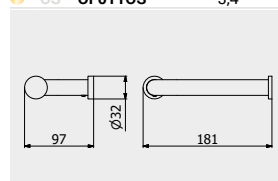

ARTICLE | ARTICOLO | ARTICLE

OF012



PACKAGING

L: 410 mm
D: 195 mm
H: 100 mm

0,3 kg

Toilet brush holder
Porta scopino da terra
Porte balayette au sol

CODE / COEFFICIENT | CODICE /
COEFFICIENTE | CODE / COEFFICIENT

CC	OF012CC	6,9
SS	OF012SS	8,6
ON	OF012ON	6,9
BO	OF012BO	8,6
NP	OF012NP	8,6
CF	OF012CF	10,4
CS	OF012CS	11,0
II	OF012II	10,4
IS	OF012IS	11,0
RS	OF012RS	10,4
SR	OF012SR	11,0
OO	OF012OO	10,4
OS	OF012OS	11,0

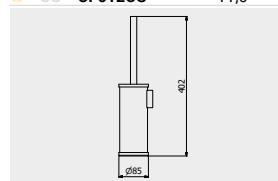

ARTICLE | ARTICOLO | ARTICLE

OF008



PACKAGING

L: 60 mm
D: 60 mm
H: 60 mm

0,08 kg

Robe Hook

Appendino a parete
Cintre

CODE / COEFFICIENT | CODICE /
COEFFICIENTE | CODE / COEFFICIENT

CC	OF008CC	1,0
SS	OF008SS	1,3
ON	OF008ON	1,0
BO	OF006BO	1,3
NP	OF008NP	1,3
CF	OF008CF	1,5
CS	OF008CS	1,6
II	OF008II	1,5
IS	OF008IS	1,6
RS	OF008RS	1,5
SR	OF008SR	1,6
OO	OF008OO	1,5
OS	OF008OS	1,6

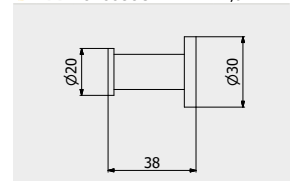

ARTICLE | ARTICOLO | ARTICLE

OF014



PACKAGING

L: 500 mm
D: 100 mm
H: 45 mm

0,4 kg

Towel holder
Porta salvietta
Porte-serviette

CODE / COEFFICIENT | CODICE /
COEFFICIENTE | CODE / COEFFICIENT

CC	OF014CC	3,7
SS	OF014SS	4,6
ON	OF014ON	3,7
BO	OF014BO	4,6
NP	OF014NP	4,6
CF	OF014CF	5,6
CS	OF014CS	5,9
II	OF014II	5,6
IS	OF014IS	5,9
RS	OF014RS	5,6
SR	OF014SR	5,9
OO	OF014OO	5,6
OS	OF014OS	5,9

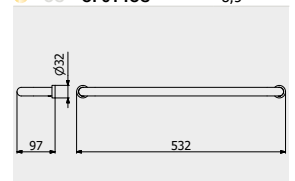

ARTICLE | ARTICOLO | ARTICLE

OF002



PACKAGING

L: 170 mm
D: 60 mm
H: 80 mm

0,6 kg

Soap dispenser holder

Porta dispenser sapone liquido
Porte distributeur de savon

CODE / COEFFICIENT | CODICE /
COEFFICIENTE | CODE / COEFFICIENT

CC	OF002CC	3,7
SS	OF002SS	4,6
ON	OF002ON	3,7
BO	OF002BO	4,6
NP	OF002NP	4,6
CF	OF002CF	5,6
CS	OF002CS	5,9
II	OF002II	5,6
IS	OF002IS	5,9
RS	OF002RS	5,6
SR	OF002SR	5,9
OO	OF002OO	5,6
OS	OF002OS	5,9

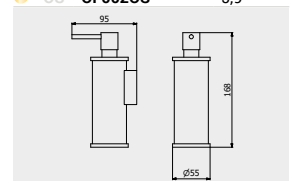



TAAAC

The round shape of square.

La forma tonda del quadrato.
La forme ronde du carré.

"Taaac, and it's already done!" A versatile project designed to simplify forms and functions, TAAAC draws its inspiration from the immediate and friendly design of the most widespread technological appliances, from their hybrid and variable forms, never completely round or square. The collection also proposes to minimize the faucet structure, in order to provide only what is really essential. Thus TAAAC becomes a symbol of practical immediacy and aesthetical hybridity, through a highly recognisable look.

"Taaac, ed è subito fatto!". Progetto versatile, volto a semplificare forme e funzioni, TAAAC prende ispirazione dal design immediato e affabile dei più diffusi apparecchi tecnologici, ispirandosi alle loro forme ibride e cangianti, mai completamente tonde né squadrate. La serie propone inoltre di ridurre al minimo le strutture del rubinetto, per fornire solo ciò di cui si ha veramente bisogno. TAAAC si fa così sinonimo di immediatezza funzionale e commistione di forme dall'alta riconoscibilità estetica.

"Taaac, et c'est déjà fait!" Projet éclectique visant à simplifier les formes et les fonctions, TAAAC s'inspire du design immédiat et aimable des appareils technologiques les plus connus, inspiré par leurs formes hybrides et changeantes, jamais complètement rondes ni carrées. La collection propose également de minimiser la structure du robinet pour ne pourvoir que ce qui est vraiment nécessaire. Ainsi, TAAAC devient un produit synonyme d'immédiateté fonctionnelle et de mélange de formes, à la forte identité esthétique.



CRYSTAL CLEAR
WATER



DOUBLE LEVER



LEAD FREE



ZINC FREE





It's a collection of mixers with the idea of expressing a new universal and shared language in the bathroom context, simplifying shapes and interaction. It just makes things easy from many perspectives.

Una serie di rubinetti sintesi di un concept che ha come obiettivo stabilire un nuovo linguaggio universale e condiviso nell'ambiente bagno, semplificando forme, usi e funzioni.

C'est une collection de mitigeurs qui exprime un nouveau langage universel et partagé dans la salle de bain, en simplifiant forme et interaction. Elle facilite les tâches de nombreux points de vue.

“ TAAAC expresses the idea of simplification, both in shape and interaction within the bathroom context. The idea with TAAAC was to shape a product of universal and shared language fitting any room and style.

TAAAC è sintesi di un concept che riduce al minimo forme, usi e funzioni nel mondo del bagno. L'obiettivo è dar forma a un prodotto dal linguaggio universale e condiviso, adatto a ogni ambiente e stile.

TAAAC se fait synthèse d'un concept visant à minimiser les formes, les usages et les fonctions dans le monde de la salle de bain. L'objectif est celui de concevoir un produit avec un langage universel et partagé, indiqué pour tous les espaces et les styles. ”

Federico Castelli design for TAAAC

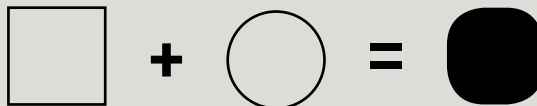

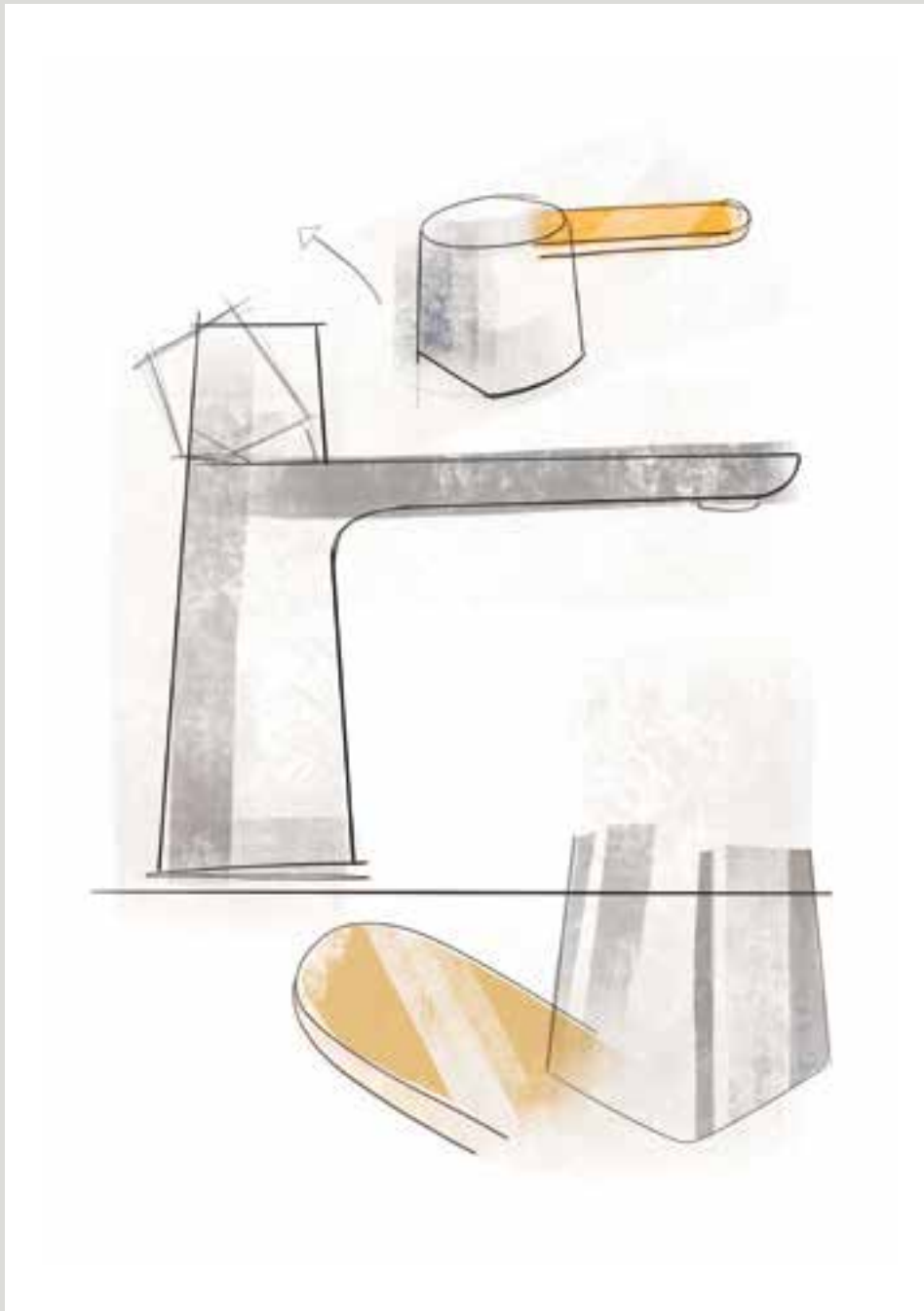



↑ AA200NP
Monohole washbasin mixer
Miscelatore lavabo monoforo
Mitigeur lavabo

→ AA202CC
Tall monohole washbasin mixer
Miscelatore lavabo monoforo alto
Mitigeur lavabo haut









↑ AA392NP
Three holes washbasin set with low spout
← Lavabo tre fori a bocca bassa
Lavabo trois trous bec bas





- ← AA202CC
Tall monohole washbasin mixer
Miscelatore lavabo monoforo alto
Mitigeur lavabo haut
- ↗ AA220CC
Monohole bidet mixer
Miscelatore bidet monoforo
Mitigeur bidet
- AA206CC
Wall mounted washbasin mixer
Miscelatore lavabo due fori a parete
Mitigeur lavabo mural



← AA314CC
Three ways wall shower mixer complete with shower kit
 Miscelatore doccia a parete con deviatore tre vie e doccino integrato
 Mitigeur douche mural trois voies avec inverseur et douchette encastrée

↙ AA300CC
One way wall shower mixer
 Miscelatore doccia a parete una via
 Mitigeur douche mural une voie

→ AA399CC
Free-standing bath filler with shower kit
 Bordo vasca da terra con kit doccia
 Bain douche complet alimentation au sol

A Diverter
 Deviatore
 Déviateur

B Mixer
 Miscelatore
 Mitigeur







↑ AA740CC
Two holes deck mounted bath filler mixer
with shower kit
Miscelatore Bordo vasca da appoggio due fori
con doccia
Mitigeur Bain/douche 2 trous avec douchette

ARTICLE | ARTICOLO | ARTICLE

AA200



Monohole washbasin mixer complete with drain
 Miscelatore lavabo monoforo completo di scarico automatico
 Mitigeur Lavabo complet avec bonde automatique

CODE / COEFFICIENT	CODICE / COEFFICIENTE	
CC	AA200CC	6,6
SS	AA200SS	8,3
BO	AA200BO	7,9
NP	AA200NP	7,9
OS	AA200OS	10,6

PACKAGING

L: 340 mm
 D: 180 mm
 H: 70 mm
 2,0 kg

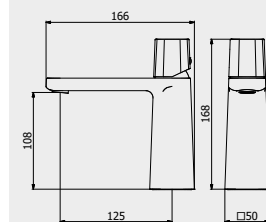

PORTATE | WATER FLOW | DÉBIT D'EAU

1 BAR	2 BAR	3 BAR
4,5 l/m	5 l/m	5 l/m

Taaac

ARTICLE | ARTICOLO | ARTICLE

AA202



Tall monohole washbasin mixer complete with drain
 Miscelatore lavabo monoforo alto completo di scarico automatico
 Mitigeur lavabo haut complet avec bonde automatique

CODE / COEFFICIENT	CODICE / COEFFICIENTE	
CC	AA202CC	10,7
SS	AA202SS	13,4
BO	AA202BO	12,8
NP	AA202NP	12,8
OS	AA202OS	17,1

PACKAGING

L: 340 mm
 D: 180 mm
 H: 70 mm
 3,0 kg

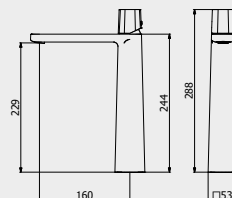

PORTATE | WATER FLOW | DÉBIT D'EAU

1 BAR	2 BAR	3 BAR
4,5 l/m	5 l/m	5 l/m

ARTICLE | ARTICOLO | ARTICLE

AA392



Three holes washbasin set with low spout
 Lavabo tre fori a bocca bassa completo di scarico automatico
 Lavabo trois trous bec bas

CODE / COEFFICIENT	CODICE / COEFFICIENTE	
CC	AA392CC	12,2
SS	AA392SS	15,3
BO	AA392BO	14,6
NP	AA392NP	14,6
OS	AA392OS	19,5

PACKAGING

L: 340 mm
 D: 180 mm
 H: 70 mm
 3,5 kg

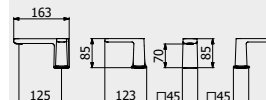

PORTATE | WATER FLOW | DÉBIT D'EAU

1 BAR	2 BAR	3 BAR
4,5 l/m	5 l/m	5 l/m

ARTICLE | ARTICOLO | ARTICLE

AA206



Wall mounted washbasin mixer complete with drain

Miscelatore lavabo due fori a parete completo di scarico automatico

Mitigeur lavabo mural complet avec bonde automatique

CODE / COEFFICIENT | CODICE /
COEFFICIENTE | CODE / COEFFICIENT

●	CC	EAA206CC	9,5
●	SS	EAA206SS	11,9
●	BO	EAA206BO	11,4
●	NP	EAA206NP	11,4
●	OS	EAA206OS	15,2

PACKAGING

 L: 265 mm
D: 260 mm
H: 70 mm

1,9 kg

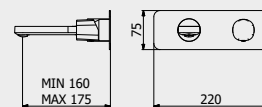

PORTATE | WATER FLOW | DÉBIT D'EAU

1 BAR	2 BAR	3 BAR
4,5 l/m	5 l/m	5 l/m

Built-in body to be purchased separately

Corpo incasso da acquistare separatamente

Corps intégré à acheter séparément



CODICE | CODE | CODE

INC206XXXN_19

COEFFICIENT | COEFFICIENTE | COEFFICIENT

2,9

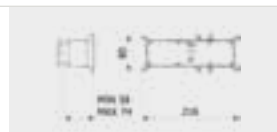

ARTICLE | ARTICOLO | ARTICLE

AA220



Monohole bidet mixer complete with drain

Miscelatore bidet monoforo completo di scarico automatico

Mitigeur bidet complet avec bonde automatique

CODE / COEFFICIENT | CODICE /
COEFFICIENTE | CODE / COEFFICIENT

●	CC	AA220CC	6,6
●	SS	AA220SS	8,3
●	BO	AA220BO	7,9
●	NP	AA220NP	7,9
●	OS	AA220OS	10,6

PACKAGING

 L: 370 mm
D: 270 mm
H: 80 mm

1,9 kg

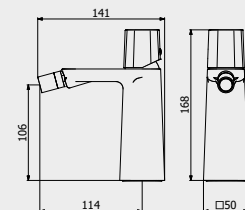

PORTATE | WATER FLOW | DÉBIT D'EAU

1 BAR	2 BAR	3 BAR
4,5 l/m	5 l/m	5 l/m

ARTICLE | ARTICOLO | ARTICLE

AA300



Exposed parts for manual wall mixer

Set di parti esterne per miscelatore a parete ad una via

Partie extérieure pour mitigeur encastré à une voie

CODE / COEFFICIENT | CODICE /
COEFFICIENTE | CODE / COEFFICIENT

●	CC	EAA300CC	4,1
●	SS	EAA300SS	5,1
●	BO	EAA300BO	4,9
●	NP	EAA300NP	4,9
●	OS	EAA300OS	6,6

PACKAGING

 L: 150 mm
D: 190 mm
H: 98 mm

1,9 kg

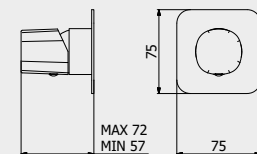

PORTATE | WATER FLOW | DÉBIT D'EAU

1 BAR	2 BAR	3 BAR
11,5 l/m	16,3 l/m	20 l/m

Built-in body to be purchased separately

Corpo incasso da acquistare separatamente

Corps intégré à acheter séparément



CODICE | CODE | CODE

INC300XXXN_19

COEFFICIENT | COEFFICIENTE | COEFFICIENT

1,8

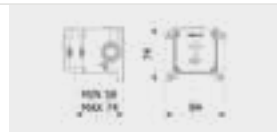

ARTICLE | ARTICOLO | ARTICLE

AA310



Exposed parts for manual wall mixer with two ways diverter
 Miscelatore doccia a parete con deviatore due vie
 Mitigeur douche mural deux voies avec inverseur

CODE / COEFFICIENT	CODICE / COEFFICIENTE	COEFFICIENT
CC	EAA310CC	6,1
SS	EAA310SS	7,6
BO	EAA310BO	7,3
NP	EAA310NP	7,3
OS	EAA310OS	9,8

PACKAGING

L: 150 mm
 D: 190 mm
 H: 98 mm
 1,9 kg

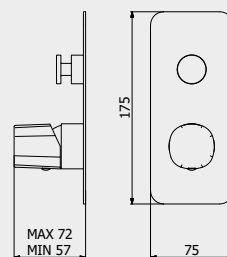

PORTATE | WATER FLOW | DÉBIT D'EAU

1 BAR	2 BAR	3 BAR
11,6 l/m	16,3 l/m	20,1 l/m

Taaac

Built-in body to be purchased separately

Corpo incasso da acquistare separatamente

Corps intégré à acheter séparément



CODICE | CODE | CODE

INC310XXXN_19

COEFFICIENTE | COEFFICIENT | COEFFICIENT

3,3



ARTICLE | ARTICOLO | ARTICLE

AA312



Exposed parts for manual wall mixer with three ways diverter
 Set di parti esterne per miscelatore a parete a tre vie
 Mitigeur douche mural trois voies avec inverseur

CODE / COEFFICIENT	CODICE / COEFFICIENTE	COEFFICIENT
CC	EAA312CC	7,4
SS	EAA312SS	9,3
BO	EAA312BO	8,9
NP	EAA312NP	8,9
OS	EAA312OS	11,8

PACKAGING

L: 150 mm
 D: 190 mm
 H: 98 mm
 1,9 kg

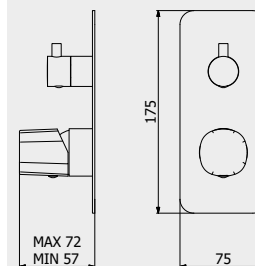

PORTATE | WATER FLOW | DÉBIT D'EAU

1 BAR	2 BAR	3 BAR
8,3 l/m	11,7 l/m	24,3 l/m

Built-in body to be purchased separately

Corpo incasso da acquistare separatamente

Corps intégré à acheter séparément



CODICE | CODE | CODE

INC312XXXN_19

COEFFICIENTE | COEFFICIENT | COEFFICIENT

3,3

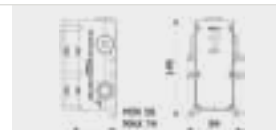

ARTICLE | ARTICOLO | ARTICLE

AA313



Two ways wall shower mixer complete with shower kit
 Miscelatore doccia a parete con deviatore due vie e doccino integrato
 Mitigeur douche mural 2 voies avec inverseur et douchette encastrée

CODE / COEFFICIENT	CODICE / COEFFICIENTE	COEFFICIENT
CC	EAA313CC	10,4
SS	EAA313SS	13,0
BO	EAA313BO	12,5
NP	EAA313NP	12,5
OS	EAA313OS	16,6

PACKAGING

L: 370 mm
 D: 270 mm
 H: 80 mm
 2,1 kg

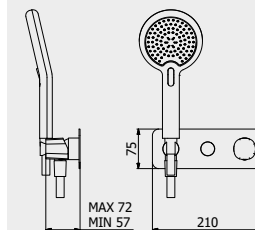

PORTATE | WATER FLOW | DÉBIT D'EAU

1 BAR	2 BAR	3 BAR
10 l/m	14,1 l/m	17,2 l/m

Built-in body to be purchased separately

Corpo incasso da acquistare separatamente

Corps intégré à acheter séparément



CODICE | CODE | CODE

INC313XXXN_19

COEFFICIENTE | COEFFICIENT | COEFFICIENT

3,6



ARTICLE | ARTICOLO | ARTICLE

AA314



Three ways wall shower mixer complete with shower kit
Miscelatore doccia a parete con deviatore tre vie e doccino integrato
Mitigeur douche mural 3 voies avec inverseur et douchette encastrée

CODE / COEFFICIENT	CODICE / COEFFICIENTE	CODE / COEFFICIENT
CC	EAA314CC	11,4
SS	EAA314SS	14,3
BO	EAA314BO	13,7
NP	EAA314NP	13,7
OS	EAA314OS	18,2

PACKAGING

L: 370 mm
D: 270 mm
H: 80 mm
2,1 kg

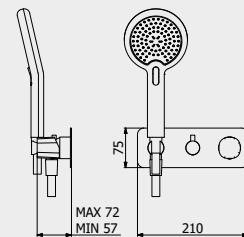

PORTATE | WATER FLOW | DÉBIT D'EAU

1 BAR	2 BAR	3 BAR
2,3 l/m	3,2 l/m	4 l/m

Built-in body to be purchased separately

Corpo incasso da acquistare separatamente

Corps intégré à acheter séparément



CODICE | CODE | CODE

INC314XXXN_19

COEFFICIENTE | COEFFICIENT | COEFFICIENT

3,7

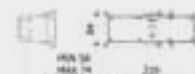

ARTICLE | ARTICOLO | ARTICLE

AA399



Free-standing bath filler with shower kit

Bordo vasca da terra con kit doccia

Bain douche complet alimentation au sol

CODE / COEFFICIENT	CODICE / COEFFICIENTE	CODE / COEFFICIENT
CC	EAA399CC	39,7
SS	EAA399SS	49,6
BO	EAA399BO	47,6
NP	EAA399NP	47,6
OS	EAA399OS	63,5

PACKAGING

L: 1160 mm
D: 360 mm
H: 180 mm
14,7 kg

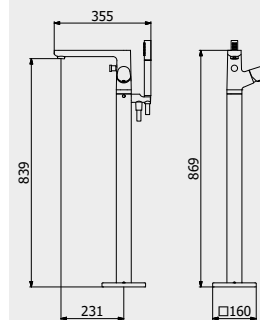

PORTATE | WATER FLOW | DÉBIT D'EAU

1 BAR	2 BAR	3 BAR
12,6 l/m	18,1 l/m	22,5 l/m

Built-in body to be purchased separately
AVAILABLE FROM JANUARY 2020

Corpo incasso da acquistare separatamente
DISPONIBILE DA GENNAIO 2020

Corps intégré à acheter séparément
DISPONIBLE À PARTIR DE JANVIER 2020



CODICE | CODE | CODE

INC399XXXN_19

COEFFICIENTE | COEFFICIENT | COEFFICIENT

2,8

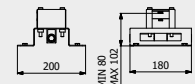

ARTICLE | ARTICOLO | ARTICLE

AA706



Exposed parts for bidet spray complete with mixer

Set di parti esterne per Idroscopino igienico con miscelatore

Partie extérieure pour douchette hygiénique avec mitigeur

CODE / COEFFICIENT	CODICE / COEFFICIENTE	CODE / COEFFICIENT
CC	EAA706CC	9,8
SS	EAA706SS	12,3
BO	EAA706BO	11,8
NP	EAA706NP	11,8
OS	EAA706OS	15,7

PACKAGING

L: 370 mm
D: 270 mm
H: 80 mm
3,1 kg

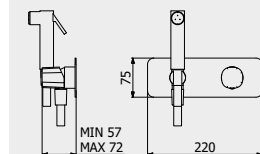

PORTATE | WATER FLOW | DÉBIT D'EAU

1 BAR	2 BAR	3 BAR
2,3 l/m	3,2 l/m	4 l/m

Built-in body to be purchased separately

Corpo incasso da acquistare separatamente

Corps intégré à acheter séparément



CODICE | CODE | CODE

INC206XXXN_19

COEFFICIENTE | COEFFICIENT | COEFFICIENT

2,9

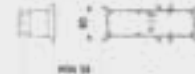

ARTICLE | ARTICOLO | ARTICLE

AA740



Two holes deck mounted bath filler mixer with shower kit
 Miscelatore bordo vasca da appoggio due fori con doccino
 Mitigeur bain/douche deux trous avec douchette

CODE / COEFFICIENT	CODICE / COEFFICIENTE	
CC	AA740CC	18,7
SS	AA740SS	23,4
BO	AA740BO	22,4
NP	AA740NP	22,4
OS	AA740OS	29,9

PACKAGING

	L: 360 mm
	D: 220 mm
	H: 150 mm
	5,5 kg

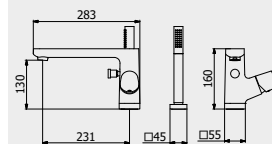

Taaac

PORTATE | WATER FLOW | DÉBIT D'EAU

1 BAR	2 BAR	3 BAR
15,5 l/m	21,4 l/m	26,8 l/m

ARTICLE | ARTICOLO | ARTICLE

AA320



Wall mounted spout
 Bocca d'erogazione a parete
 Bec de remplissage mural

CODE / COEFFICIENT	CODICE / COEFFICIENTE	
CC	AA320CC	4,0
SS	AA320SS	5,0
BO	AA320BO	4,8
NP	AA320NP	4,8
OS	AA320OS	6,4

PACKAGING

	L: 150 mm
	D: 190 mm
	H: 98 mm
	1,1 kg

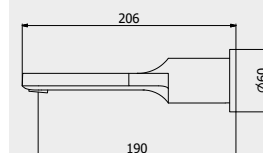

PORTATE | WATER FLOW | DÉBIT D'EAU

1 BAR	2 BAR	3 BAR
4,5 l/m	5 l/m	5 l/m

ARTICLE | ARTICOLO | ARTICLE

AA323



Wall mounted spout with diverter
 Bocca a parete con deviatore integrato e attacco per flessibile doccia
 Bec Mural avec déviateur, mitigeur, douchette et flexible

CODE / COEFFICIENT	CODICE / COEFFICIENTE	
CC	AA323CC	5,6
SS	AA323SS	7,0
BO	AA323BO	6,7
NP	AA323NP	6,7
OS	AA323OS	9,0

PACKAGING

	L: 150 mm
	D: 190 mm
	H: 98 mm
	1,1 kg

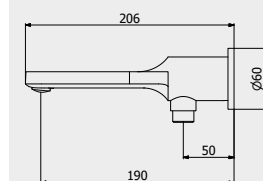

PORTATE | WATER FLOW | DÉBIT D'EAU

1 BAR	2 BAR	3 BAR
29,2 l/m	41,3 l/m	50,6 l/m

ARTICLE | ARTICOLO | ARTICLE

AA024



Duplex TAAAC
 Duplex TAAAC
 Duplex TAAAC

CODE / COEFFICIENT	CODICE / COEFFICIENTE	
CC	AA024CC	3,5
SS	AA024SS	4,4
BO	AA024BO	4,4
NP	AA024NP	4,4

PACKAGING

	L: 265 mm
	D: 260 mm
	H: 70 mm
	1,4 kg

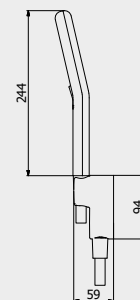

PORTATE | WATER FLOW | DÉBIT D'EAU

1 BAR	2 BAR	3 BAR
5,3 l/m	7,6 l/m	9,4 l/m

TAAAC / ACCESSORIES COLLECTION

ARTICLE | ARTICOLO | ARTICLE

AA001



Soap-holder

Porta sapone
Porte de savonCODE / COEFFICIENT | CODICE /
COEFFICIENTE | CODE / COEFFICIENT

CC	AA001CC	1,1
SS	AA001SS	1,4

PACKAGING

	L: 130 mm		0,2 kg
	D: 90 mm		
	H: 20 mm		

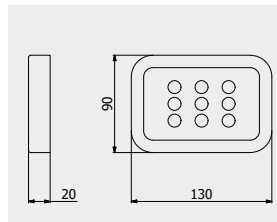

ARTICLE | ARTICOLO | ARTICLE

AA002



Soap dispenser

Dispenser sapone liquido
Distributeur de savonCODE / COEFFICIENT | CODICE /
COEFFICIENTE | CODE / COEFFICIENT

CC	AA002CC	2,4
SS	AA002SS	3,0

PACKAGING

	L: 100 mm		0,5 kg
	D: 72 mm		
	H: 182 mm		

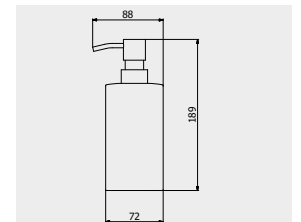

ARTICLE | ARTICOLO | ARTICLE

AA003



Toothbrush holder

Bicchiere porta spazzolino
Porte-verreCODE / COEFFICIENT | CODICE /
COEFFICIENTE | CODE / COEFFICIENT

CC	AA003CC	1,2
SS	AA003SS	1,5

PACKAGING

	L: 72 mm		0,3 kg
	D: 72 mm		
	H: 100 mm		

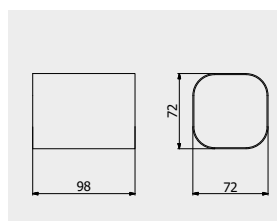

ARTICLE | ARTICOLO | ARTICLE

AA004



Towel holder

Porta salvietta
Porte-servietteCODE / COEFFICIENT | CODICE /
COEFFICIENTE | CODE / COEFFICIENT

CC	AA004CC	2,7
SS	AA004SS	3,4

PACKAGING

	L: 600 mm		0,5 kg
	D: 86 mm		
	H: 70 mm		

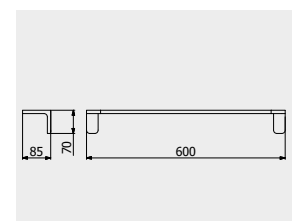



ARTICLE | ARTICOLO | ARTICLE

AA005

Towel holder
Porta salvietta
Porte-serviette

CODE / COEFFICIENT	CODICE / COEFFICIENTE	CODE / COEFFICIENT
CC	AA005CC	2,5
SS	AA005SS	3,1

PACKAGING

 L: 450 mm	 0,4 kg
D: 86 mm	
H: 70 mm	

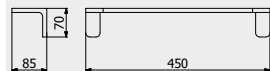



ARTICLE | ARTICOLO | ARTICLE

AA006

Towel holder
Porta salvietta
Porte-serviette

CODE / COEFFICIENT	CODICE / COEFFICIENTE	CODE / COEFFICIENT
CC	AA006CC	2,3
SS	AA006SS	2,9

PACKAGING

 L: 300 mm	 0,3 kg
D: 86 mm	
H: 70 mm	

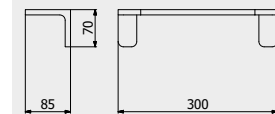

Taaac

ARTICLE | ARTICOLO | ARTICLE

AA008

Robe Hook
Appendino a parete
Cintre

CODE / COEFFICIENT	CODICE / COEFFICIENTE	CODE / COEFFICIENT
CC	AA008CC	1,8
SS	AA008SS	2,3

PACKAGING

 L: 35 mm	 0,2 kg
D: 50 mm	
H: 112 mm	

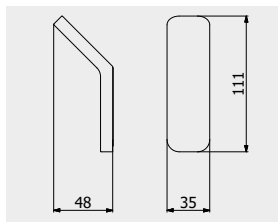

ARTICLE | ARTICOLO | ARTICLE

AA0011

Toilet paper holder
Porta rotolo
Porte rouleaux de toilette

CODE / COEFFICIENT	CODICE / COEFFICIENTE	CODE / COEFFICIENT
CC	AA011CC	1,8
SS	AA011SS	2,3

PACKAGING

 L: 161 mm	 0,2 kg
D: 86 mm	
H: 80 mm	

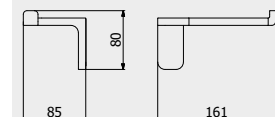



ARTICLE | ARTICOLO | ARTICLE

AA0012

Toilet brush holder
Porta scopino da terra
Porte balayette au sol

CODE / COEFFICIENT	CODICE / COEFFICIENTE	CODE / COEFFICIENT
CC	AA012CC	3,8
SS	AA012SS	4,8

PACKAGING

 L: 80 mm	 1,0 kg
D: 80 mm	
H: 390 mm	

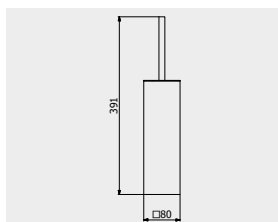

K2

Rounded and essential outlines is the language of elegance.

Contorni arrotondati ed essenziali sono il linguaggio dell'eleganza.
Les contours arrondis et essentiels sont le langage de l'élégance.

A faucet should give delightful sensations when used. K2 has a soft and pleasant shape. This contemporary collection is inspired to my style made of simplicity and clean features - it is very refined and pragmatic.

Rounded and essential outlines, which honour the elegant and sophisticated author's design, by soberly integrating in all kind of environment.

Un rubinetto dovrebbe dare sensazioni piacevoli quando lo si usa. K2 ha una forma morbida e gradevole. Questa collezione contemporanea si ispira al mio stile fatto di semplicità e linee pulite - è elegantissima e funzionale.

Tratti arrotondati ed essenziali, che mantengono tutta l'eleganza e la sofisticatezza del design d'autore, integrandosi sobriamente in tutti gli ambienti.

Un robinet devrait donner des sensations agréables lors de son utilisation. K2 possède une forme douce et agréable. Cette collection contemporaine est inspirée par mon style, fait de simplicité et de lignes épurées. Elle est très élégante et fonctionnelle. Les traits arrondis et essentiels conservent toute l'élégance et la sophistication du design de l'auteure, en s'intégrant sobrement dans tout environnement.



ANTI-LIMESCALE



CRYSTAL CLEAR
WATER



LEAD FREE



ZINC FREE







- ↑ K2209CC
 Mono hole wall mounted washbasin mixer
 Miscelatore lavabo a parete monoforo
 Mitigeur lavabo Mural monotrou
- ↙ K2200CC
 Monohole washbasin mixer
 Miscelatore lavabo monoforo
 Mitigeur lavabo
- K2200CC
 Monohole washbasin mixer
 Miscelatore lavabo monoforo
 Mitigeur lavabo







➤ K2202RS
Tall monohole washbasin mixer
Miscelatore lavabo monoforo alto
Mitigeur lavabo haut

← K2202CC
Tall monohole washbasin mixer
Miscelatore lavabo monoforo alto
Mitigeur lavabo haut





↗ K2299CC
Monohole free-standing washbasin mixer
Miscelatore lavabo da terra
Mitigeur lavabo free standing

← K2210CC
Ceiling spout with wall mounted mixer
Bocca da soffitto con comando remoto ad incasso
Mitigeur lavabo mural avec bec plafond



← K2250CC
Wall mounted bath filler with hand shower kit
Bordo vasca esterno a parete di kit doccia
Mitigeur Bain/douche Mural avec douchette
encastrée

→ K2300CC
One way wall shower mixer
Miscelatore doccia a parete una via
Mitigeur douche mural une voie

↓ K2313CC
Two ways wall shower mixer complete with
shower kit
Miscelatore doccia a parete con deviatore due vie e
doccino integrato
Mitigeur douche mural deux voies avec
inverseur et douchette encastrée



K2



- ↖ **K2350CC**
 Wall mounted shower mixer with shower kit
 Doccia esterno a parete di kit doccia
 Mitigeur de douche externe avec flexible et
 douchette
- ← **K2706CC**
 Exposed parts for bidet spray complete with
 mixer
 Set di parti esterne per Idroscopino igienico
 con miscelatore
 Partie extérieure pour douchette hygiénique
 avec mitigeur
- **K2800CC**
 Shower column with mixer and shower kit
 Colonna doccia con miscelatore e e kit doccia
 Colonne de douche avec mitigeur et kit douche

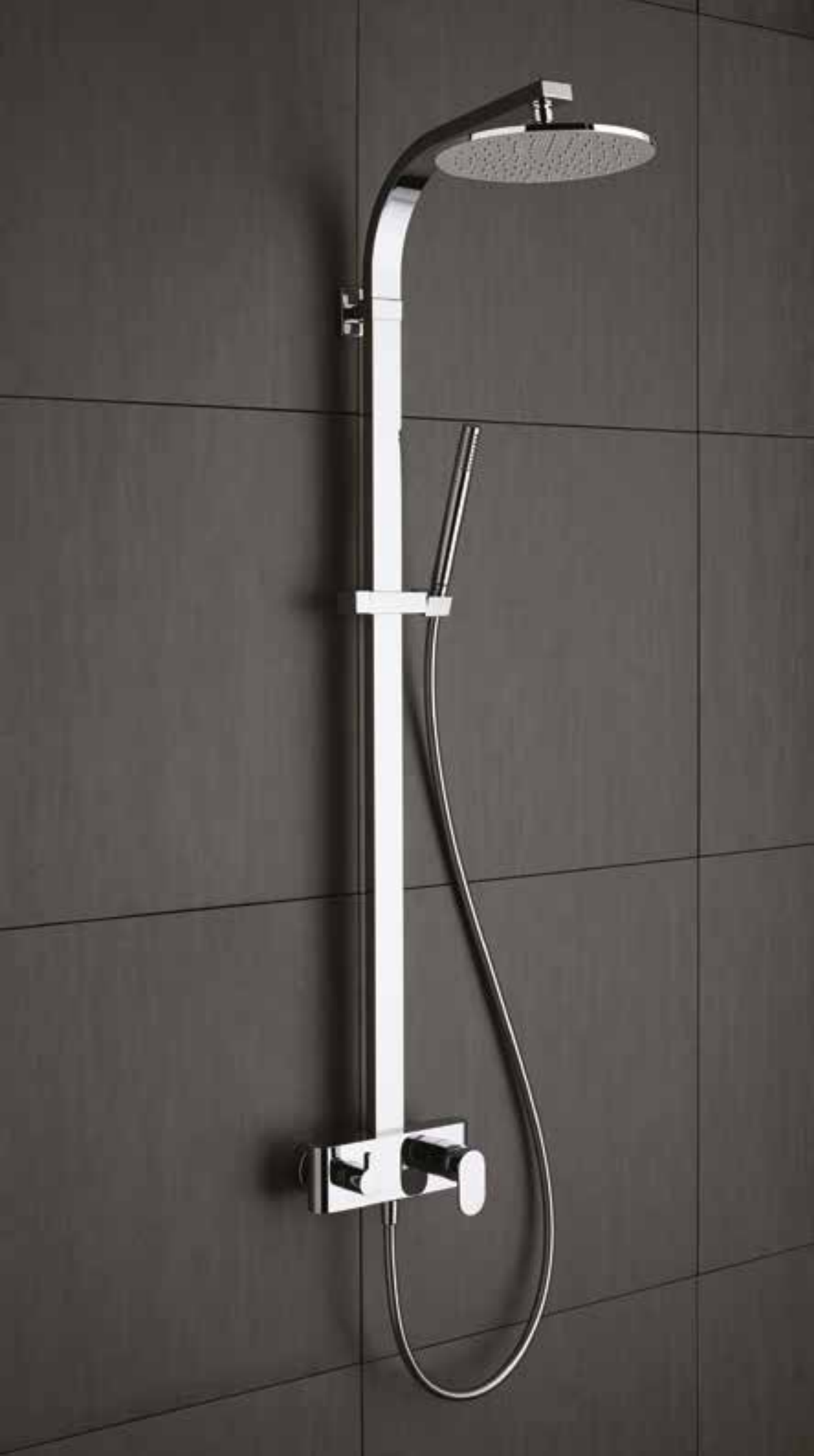

ARTICLE | ARTICOLO | ARTICLE

K2200



Monohole washbasin mixer complete with drain

Miscelatore lavabo monoforo completo di scarico automatico

Mitigeur Lavabo complet avec bonde automatique

CODE / COEFFICIENT | CODICE /
COEFFICIENTE | CODE / COEFFICIENT

● CC	K2200CC	7,0
● PL	K2200PL	11,2
● SS	K2200SS	8,8
● BO	K2200BO	8,4
● NP	K2200NP	8,4
● II	K2200II	10,5
● IS	K2200IS	11,2
● RS	K2200RS	10,5
● OO	K2200OO	10,5

PACKAGING

L: 340 mm
D: 180 mm
H: 70 mm

1,8 kg

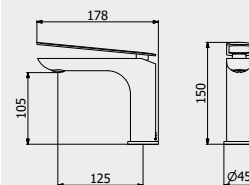

PORTATE | WATER FLOW | DÉBIT D'EAU

1 BAR	2 BAR	3 BAR
3,5 l/m	4,8 l/m	5,2 l/m

ARTICLE | ARTICOLO | ARTICLE

K2201



Mini monohole washbasin mixer complete with drain

Miscelatore lavabo monoforo mini completo di scarico automatico

Mitigeur lavabo Mini complet avec bonde automatique

CODE / COEFFICIENT | CODICE /
COEFFICIENTE | CODE / COEFFICIENT

● CC	K2201CC	6,0
● PL	K2201PL	9,6
● SS	K2201SS	7,5
● BO	K2201BO	7,2
● NP	K2201NP	7,2
● II	K2201II	9,0
● IS	K2201IS	9,6
● RS	K2201RS	9,0
● OO	K2201OO	9,0

PACKAGING

L: 340 mm
D: 180 mm
H: 70 mm

1,4 kg

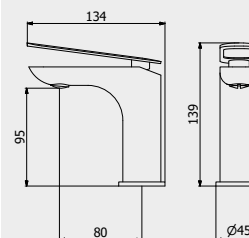

PORTATE | WATER FLOW | DÉBIT D'EAU

1 BAR	2 BAR	3 BAR
3,5 l/m	4,8 l/m	5,2 l/m

ARTICLE | ARTICOLO | ARTICLE

K2202



Tall monohole washbasin mixer complete with drain

Miscelatore lavabo monoforo alto completo di scarico automatico

Mitigeur lavabo Haut complet avec bonde automatique

CODE / COEFFICIENT | CODICE /
COEFFICIENTE | CODE / COEFFICIENT

● CC	K2202CC	9,2
● PL	K2202PL	14,7
● SS	K2202SS	11,5
● BO	K2202BO	11,0
● NP	K2202NP	11,0
● II	K2202II	13,8
● IS	K2202IS	14,7
● RS	K2202RS	13,8
● OO	K2202OO	13,8

PACKAGING

L: 370 mm
D: 270 mm
H: 80 mm

2,4 kg

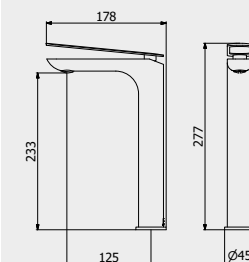

PORTATE | WATER FLOW | DÉBIT D'EAU

1 BAR	2 BAR	3 BAR
3,5 l/m	4,8 l/m	5,2 l/m



ARTICLE | ARTICOLO | ARTICLE

K2209



Monohole wall mounted washbasin mixer

Miscelatore lavabo a parete monoforo completo di scarico automatico

Mitigeur lavabo mural monotrou complet avec bonde automatique

CODE / COEFFICIENT	CODICE / COEFFICIENTE	COEFFICIENT
CC	K2209CC	13,1
PL	K2209PL	21,0
SS	K2209SS	16,4
BO	K2209BO	15,7
NP	K2209NP	15,7
II	K2209II	19,7
IS	K2209IS	21,0
RS	K2209RS	19,7
OO	K2209OO	19,7

PACKAGING

L: 425 mm
D: 188 mm
H: 98 mm

3,3 kg

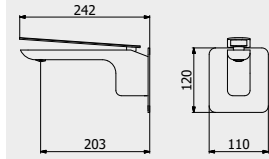

PORTATE | WATER FLOW | DÉBIT D'EAU

1 BAR	2 BAR	3 BAR
3,9 l/m	5 l/m	5,2 l/m

ARTICLE | ARTICOLO | ARTICLE

K2210

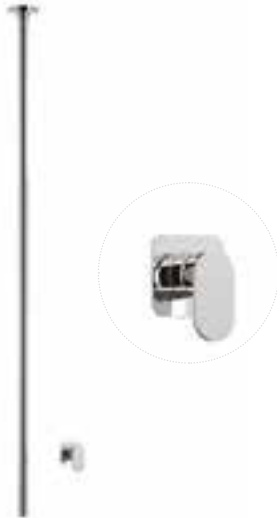

Ceiling spout with wall mounted mixer

Bocca da soffitto con comando remoto ad incasso

Mitigeur lavabo mural avec bec plafond complet avec bonde automatique

CODE / COEFFICIENT	CODICE / COEFFICIENTE	COEFFICIENT
CC	EK2210CC	27,5
SS	EK2210SS	34,4
BO	EK2210BO	33,0
NP	EK2210NP	33,0

PACKAGING

L: 150 mm
D: 190 mm
H: 98 mm

L: 1700 mm
Ø: 70 mm

4,5 kg

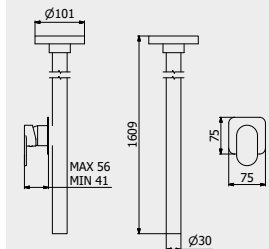

PORTATE | WATER FLOW | DÉBIT D'EAU

1 BAR	2 BAR	3 BAR
6,4 l/m	8,9 l/m	11,00 l/m

Built-in body to be purchased separately

Corpo incasso da acquistare separatamente

Corps intégré à acheter séparément



CODICE | CODE | CODE

INC300XXXN_19

COEFFICIENTE | COEFFICIENT | COEFFICIENT

1,8

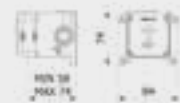

ARTICLE | ARTICOLO | ARTICLE

K2299



Monohole free-standing washbasin mixer complete with drain
 Miscelatore lavabo da terra completo di scarico automatico
 Mitigeur Lavabo Free standing complet avec bonde automatique

CODE / COEFFICIENT	CODICE / COEFFICIENTE	CODE / COEFFICIENT
CC	EK2299CC	28,8
PL	EK2299PL	46,0
SS	EK2299SS	35,9
BO	EK2299BO	34,5
NP	EK2299NP	34,5
II	EK2299II	43,1
IS	EK2299IS	46,0
RS	EK2299RS	43,1
OO	EK2299OO	43,1

PACKAGING

L: 1160 mm
D: 360 mm
H: 180 mm

11,2 kg

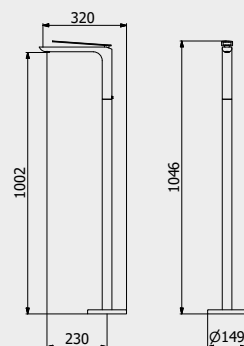

PORTATE | WATER FLOW | DÉBIT D'EAU

1 BAR	2 BAR	3 BAR
3,6 l/m	5,1 l/m	5,5 l/m

Built-in body to be purchased separately
 AVAILABLE FROM JANUARY 2020

Corpo incasso da acquistare separatamente
 DISPONIBILE DA GENNAIO 2020

Corps intégré à acheter séparément
 DISPONIBLE À PARTIR DE JANVIER 2020



CODICE | CODE | CODE

INC399XXXN_19

COEFFICIENTE | COEFFICIENT | COEFFICIENT

2,8

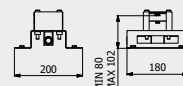

ARTICLE | ARTICOLO | ARTICLE

K2220



Monohole bidet mixer complete with drain

Miscelatore bidet monoforo completo di scarico automatico
 Mitigeur bidet complet avec bonde automatique

CODE / COEFFICIENT	CODICE / COEFFICIENTE	CODE / COEFFICIENT
CC	K2220CC	6,5
PL	K2220PL	10,4
SS	K2220SS	8,1
BO	K2220BO	7,8
NP	K2220NP	7,8
II	K2220II	9,8
IS	K2220IS	10,4
RS	K2220RS	9,8
OO	K2220OO	9,8

PACKAGING

L: 340 mm
D: 180 mm
H: 70 mm

1,7 kg

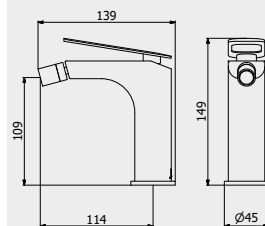

PORTATE | WATER FLOW | DÉBIT D'EAU

1 BAR	2 BAR	3 BAR
3,5 l/m	4,9 l/m	5,4 l/m

ARTICLE | ARTICOLO | ARTICLE

K2300



Exposed parts for manual wall mixer

Set di parti esterne per miscelatore a parete ad una via
 Partie extérieure pour mitigeur encastré à une voie

CODE / COEFFICIENT	CODICE / COEFFICIENTE	CODE / COEFFICIENT
CC	EK2300CC	4,1
PL	EK2300PL	6,6
SS	EK2300SS	5,1
BO	EK2300BO	4,9
NP	EK2300NP	4,9
II	EK2300II	6,2
IS	EK2300IS	6,6
RS	EK2300RS	6,2
OO	EK2300OO	6,2

PACKAGING

L: 150 mm
D: 190 mm
H: 98 mm

1,7 kg

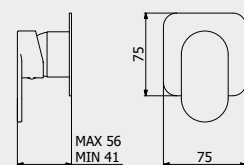

PORTATE | WATER FLOW | DÉBIT D'EAU

1 BAR	2 BAR	3 BAR
11,5 l/m	16,3 l/m	20 l/m

Built-in body to be purchased separately

Corpo incasso da acquistare separatamente

Corps intégré à acheter séparément



CODICE | CODE | CODE

INC300XXXN_19

COEFFICIENTE | COEFFICIENT | COEFFICIENT

1,8

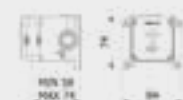

ARTICLE | ARTICOLO | ARTICLE

K2310



Exposed parts for manual wall mixer with two ways diverter
 Miscelatore doccia a parete con deviatore due vie
 Mitigeur douche mural deux voies avec inverseur

CODE / COEFFICIENTE	CODICE / COEFFICIENTE	
CC	EK2310CC	6,1
PL	EK2310PL	9,8
SS	EK2310SS	7,6
BO	EK2310BO	7,3
NP	EK2310NP	7,3
II	EK2310II	9,2
IS	EK2310IS	9,8
RS	EK2310RS	9,2
OO	EK2310OO	9,2

PACKAGING

L: 150 mm
 D: 190 mm
 H: 98 mm
 1,8 kg

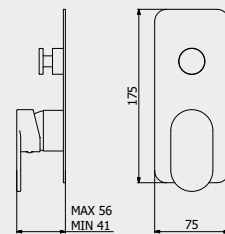

PORTATE | WATER FLOW | DÉBIT D'EAU

1 BAR	2 BAR	3 BAR
9,2 l/m	12,8 l/m	16 l/m

K2

Built-in body to be purchased separately
 Corpo incasso da acquistare separatamente
 Corps intégré à acheter séparément



CODICE | CODE | CODE

INC310XXXN_19

COEFFICIENTE | COEFFICIENT | COEFFICIENT

3,3

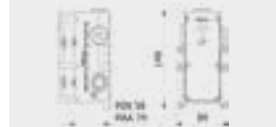

ARTICLE | ARTICOLO | ARTICLE

K2312



Exposed parts for manual wall mixer with three ways diverter
 Set di parti esterne per miscelatore a parete a tre vie
 Mitigeur douche mural trois voies avec inverseur

CODE / COEFFICIENTE	CODICE / COEFFICIENTE	
CC	EK2312CC	7,4
PL	EK2312PL	11,8
SS	EK2312SS	9,3
BO	EK2312BO	8,9
NP	EK2312NP	8,9
II	EK2312II	11,1
IS	EK2312IS	11,8
RS	EK2312RS	11,1
OO	EK2312OO	11,1

PACKAGING

L: 150 mm
 D: 190 mm
 H: 98 mm
 1,8 kg

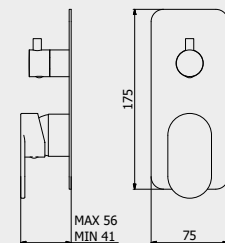

PORTATE | WATER FLOW | DÉBIT D'EAU

1 BAR	2 BAR	3 BAR
8,3 l/m	11,7 l/m	14,3 l/m

Built-in body to be purchased separately
 Corpo incasso da acquistare separatamente
 Corps intégré à acheter séparément



CODICE | CODE | CODE

INC312XXXN_19

COEFFICIENTE | COEFFICIENT | COEFFICIENT

3,3



ARTICLE | ARTICOLO | ARTICLE

K2313



Exposed parts for manual wall mixer with 2 ways with shower kit
 Set di parti esterne per miscelatore a parete a due vie completo di kit doccia
 Partie extérieure pour mitigeur encastré à deux voies avec douchette

CODE / COEFFICIENTE	CODICE / COEFFICIENTE	
CC	EK2313CC	10,1
PL	EK2313PL	16,2
SS	EK2313SS	12,6
BO	EK2313BO	12,1
NP	EK2313NP	12,1
II	EK2313II	15,2
IS	EK2313IS	16,2
RS	EK2313RS	15,2
OO	EK2313OO	15,2

PACKAGING

L: 370 mm
 D: 270 mm
 H: 80 mm
 2,2 kg

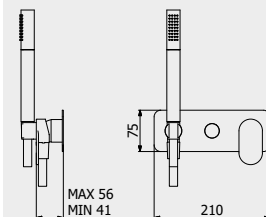

PORTATE | WATER FLOW | DÉBIT D'EAU

1 BAR	2 BAR	3 BAR
10 l/m	14,1 l/m	17,2 l/m

Built-in body to be purchased separately
 Corpo incasso da acquistare separatamente
 Corps intégré à acheter séparément



CODICE | CODE | CODE

INC313XXXN_19

COEFFICIENTE | COEFFICIENT | COEFFICIENT

3,6



ARTICLE | ARTICOLO | ARTICLE

K2314



Exposed parts for manual wall mixer with 3 ways with shower kit
Set di parti esterne per miscelatore a parete a tre vie completo di kit doccia
Partie extérieure pour mitigeur encastré à trois voies avec douchette

CODE / COEFFICIENT	CODICE / COEFFICIENTE	COEFFICIENT
CC	EK2314CC	11,4
PL	EK2314PL	18,2
SS	EK2314SS	14,3
BO	EK2314BO	13,7
NP	EK2314NP	13,7
II	EK2314II	17,1
IS	EK2314IS	18,2
RS	EK2314RS	17,1
OO	EK2314OO	17,1

PACKAGING

L: 370 mm
D: 270 mm
H: 80 mm

2,2 kg

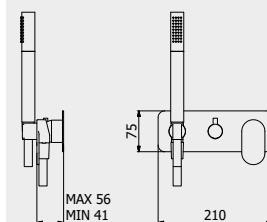

PORTATE | WATER FLOW | DÉBIT D'EAU

1 BAR	2 BAR	3 BAR
8,3 l/m	11,7 l/m	14,3 l/m

Built-in body to be purchased separately

Corpo incasso da acquistare separatamente

Corps intégré à acheter séparément



CODICE | CODE | CODE

INC314XXXN_19

COEFFICIENTE | COEFFICIENT | COEFFICIENT

3,7



ARTICLE | ARTICOLO | ARTICLE

K2800



Shower column with mixer and shower kit
Colonna doccia con miscelatore e e kit doccia
Colonne de douche avec mitigeur et kit douche

CODE / COEFFICIENT	CODICE / COEFFICIENTE	COEFFICIENT
CC	K2800CC	26,7

PACKAGING

L: 1200 mm
D: 400 mm
H: 170 mm

11,6 kg

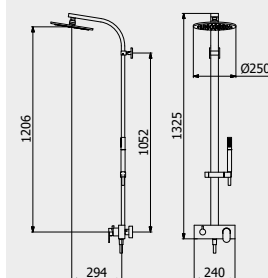

PORTATE | WATER FLOW | DÉBIT D'EAU

1 BAR	2 BAR	3 BAR
6,4 l/m	8,9 l/m	11,00 l/m

ARTICLE | ARTICOLO | ARTICLE

K2350



Wall mounted shower mixer with shower kit
Doccia esterno a parete completo di kit doccia
Mitigeur de douche externe avec flexible et douchette

CODE / COEFFICIENT	CODICE / COEFFICIENTE	COEFFICIENT
CC	K2350CC	10,9
PL	K2350PL	17,4
SS	K2350SS	13,6
BO	K2350BO	13,1
NP	K2350NP	13,1
II	K2350II	16,4
IS	K2350IS	17,4
RS	K2350RS	16,4
OO	K2350OO	16,4

PACKAGING

L: 360 mm
D: 220 mm
H: 150 mm

3,5 kg

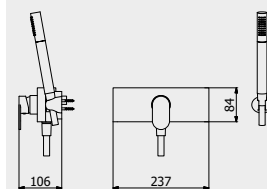

PORTATE | WATER FLOW | DÉBIT D'EAU

1 BAR	2 BAR	3 BAR
11,5 l/m	18,4 l/m	23,3 l/m



ARTICLE | ARTICOLO | ARTICLE

K2399



Free-standing bath filler with shower kit

Bordo vasca da terra con kit doccia

Bain douche complet alimentation au sol

CODE / COEFFICIENT | CODICE / COEFFICIENTE | CODE / COEFFICIENT

CC	EK2399CC	32,6
PL	EK2399PL	52,2
SS	EK2399SS	40,8
BO	EK2399BO	39,1
NP	EK2399NP	39,1
II	EK2399II	48,9
IS	EK2399IS	52,2
RS	EK2399RS	48,9
OO	EK2399OO	48,9

PACKAGING

L: 1160 mm
D: 360 mm
H: 180 mm

14 kg

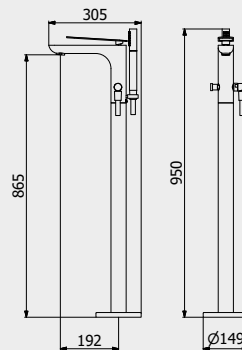

PORTATE | WATER FLOW | DÉBIT D'EAU

1 BAR	2 BAR	3 BAR
13 l/m	19 l/m	24 l/m

Built-in body to be purchased separately

AVAILABLE FROM JANUARY 2020

Corpo incasso da acquistare separatamente
DISPONIBILE DA GENNAIO 2020

Corps intégré à acheter séparément
DISPONIBLE À PARTIR DE JANVIER 2020



CODICE | CODE | CODE

INC399XXXN_19

COEFFICIENTE | COEFFICIENT | COEFFICIENT

2,8

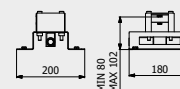

ARTICLE | ARTICOLO | ARTICLE

K2250



Wall mounted bath filler complete with hand shower kit

Bordo vasca esterno a parete completo di kit doccia

Mitigeur Bain/douche Mural avec douchette encastrée

CODE / COEFFICIENT | CODICE / COEFFICIENTE | CODE / COEFFICIENT

CC	K2250CC	15,3
PL	K2250PL	24,5
SS	K2250SS	19,1
BO	K2250BO	18,4
NP	K2250NP	18,4
II	K2250II	23,0
IS	K2250IS	24,5
RS	K2250RS	23,0
OO	K2250OO	23,0

PACKAGING

L: 353 mm
D: 225 mm
H: 226 mm

4,9 kg

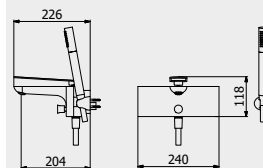

PORTATE | WATER FLOW | DÉBIT D'EAU

1 BAR	2 BAR	3 BAR
9,2 l/m	14,2 l/m	17,6 l/m

ARTICLE | ARTICOLO | ARTICLE

RU319



Wall mounted waterfall

Cascata a parete con erogazione diretta

Cascade murale

CODE / COEFFICIENT | CODICE / COEFFICIENTE | CODE / COEFFICIENT

CC	RU319CC	12,8
SS	RU319SS	16,0
BO	RU319BO	15,4
NP	RU319NP	15,4
CF	RU319CF	19,2
CS	RU319CS	20,5
II	RU319II	19,2
IS	RU319IS	20,5
RS	RU319RS	19,2
SR	RU319SR	20,5
OO	RU319OO	19,2
OS	RU319OS	20,5

PACKAGING

L: 340 mm
D: 180 mm
H: 70 mm

3,1 kg

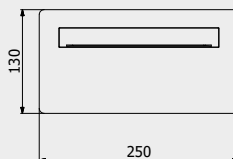

PORTATE | WATER FLOW | DÉBIT D'EAU

1 BAR	2 BAR	3 BAR
13 l/m	17 l/m	20 l/m

ARTICLE | ARTICOLO | ARTICLE

K2320



Wall mounted spout

Bocca d'erogazione a parete

Bec de remplissage mural



CODE / COEFFICIENT	CODICE / COEFFICIENTE	COEFFICIENT
CC	K2320CC	2,1
PL	K2320PL	3,4
SS	K2320SS	2,6
BO	K2320BO	2,5
NP	K2320NP	2,5
II	K2320II	3,2
IS	K2320IS	3,4
RS	K2320RS	3,2
OO	K2320OO	3,2

PACKAGING

L: 175 mm
D: 125 mm
H: 90 mm

0,24 kg

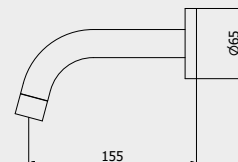

PORTATE | WATER FLOW | DÉBIT D'EAU

1 BAR	2 BAR	3 BAR
10 l/m	14l/m	17 l/m

ARTICLE | ARTICOLO | ARTICLE

K2321



Short wall mounted spout

Bocca d'erogazione corta a parete

Bec de remplissage mural court



CODE / COEFFICIENT	CODICE / COEFFICIENTE	COEFFICIENT
CC	K2321CC	2,5
PL	K2321PL	4,0
SS	K2321SS	3,1
BO	K2321BO	3,0
NP	K2321NP	3,0
II	K2321II	3,8
IS	K2321IS	4,0
RS	K2321RS	3,8
OO	K2321OO	3,8

PACKAGING

L: 175 mm
D: 125 mm
H: 90 mm

0,23 kg

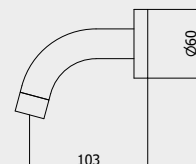

PORTATE | WATER FLOW | DÉBIT D'EAU

1 BAR	2 BAR	3 BAR
10 l/m	14l/m	17 l/m

ARTICLE | ARTICOLO | ARTICLE

K2322



Long wall mounted spout

Bocca d'erogazione lunga a parete

Bec de remplissage mural long



CODE / COEFFICIENT	CODICE / COEFFICIENTE	COEFFICIENT
CC	K2322CC	2,5
PL	K2322PL	4,0
SS	K2322SS	3,1
BO	K2322BO	3,0
NP	K2322NP	3,0
II	K2322II	3,8
IS	K2322IS	4,0
RS	K2322RS	3,8
OO	K2322OO	3,8

PACKAGING

L: 175 mm
D: 125 mm
H: 90 mm

0,25 kg

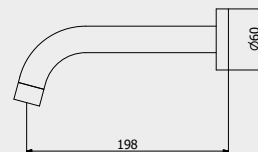

PORTATE | WATER FLOW | DÉBIT D'EAU

1 BAR	2 BAR	3 BAR
10 l/m	14l/m	17 l/m



ARTICLE | ARTICOLO | ARTICLE

K2706



Exposed parts for bidet spray complete with mixer
 Set di parti esterne per Idroscopino igienico con miscelatore
 Partie extérieure pour douchette hygiénique avec mitigeur

CODE / COEFFICIENT	CODICE / COEFFICIENTE	COEFFICIENT
CC	EK2706CC	9,8
PL	EK2706PL	15,7
SS	EK2706SS	12,3
BO	EK2706BO	11,8
NP	EK2706NP	11,8
II	EK2706II	14,7
IS	EK2706IS	15,7
RS	EK2706RS	14,7
OO	EK2706OO	14,7

PACKAGING

L: 370 mm
 D: 270 mm
 H: 80 mm
 3,1 kg

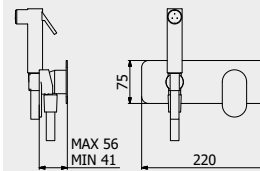

PORTATE | WATER FLOW | DÉBIT D'EAU

1 BAR	2 BAR	3 BAR
2,3 l/m	3,2 l/m	4 l/m

K2

Built-in body to be purchased separately

Corpo incasso da acquistare separatamente

Corps intégré à acheter séparément



CODICE | CODE | CODE

INC206XXXN_19

COEFFICIENTE | COEFFICIENT | COEFFICIENT

2,9



MODERNA / ACCESSORIES COLLECTION

ARTICLE | ARTICOLO | ARTICLE

MO001

Wall soap-holder

Porta sapone a muro

Porte distributeur de savon encastré

CODE / COEFFICIENT | CODICE /
COEFFICIENTE | CODE / COEFFICIENT

CC MO001CC 1,5

PACKAGING

L: 110 mm
 D: 130 mm
 H: 50 mm
 0,4 kg

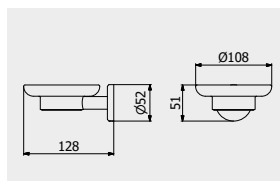

ARTICLE | ARTICOLO | ARTICLE

MO002

Wall soap dispenser holder

Porta dispenser sapone liquido a parete

Porte distributeur de savon en verre gravé

CODE / COEFFICIENT | CODICE /
COEFFICIENTE | CODE / COEFFICIENT

CC MO002CC 2,3

PACKAGING

L: 80 mm
 D: 130 mm
 H: 180 mm
 0,1 kg

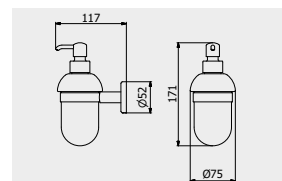

ARTICLE | ARTICOLO | ARTICLE

MO003

Wall toothbrush holder

Bicchieri porta spazzolino a parete

Porte-verre en verre gravé

CODE / COEFFICIENT | CODICE /
COEFFICIENTE | CODE / COEFFICIENT

CC MO003CC 1,5

PACKAGING

L: 70 mm
 D: 110 mm
 H: 100 mm
 0,4 kg

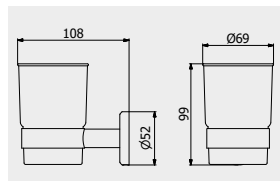

ARTICLE | ARTICOLO | ARTICLE

MO004

Towel holder

Porta salvietta

Porte-serviette

CODE / COEFFICIENT | CODICE /
COEFFICIENTE | CODE / COEFFICIENT

CC MO004CC 2,4

PACKAGING

L: 650 mm
 D: 70 mm
 H: 50 mm
 0,5 kg

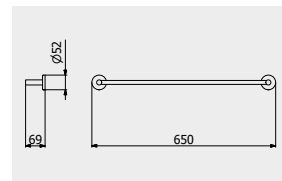

ARTICLE | ARTICOLO | ARTICLE

MO014

Towel holder

Porta salvietta

Porte-serviette

CODE / COEFFICIENT | CODICE /
COEFFICIENTE | CODE / COEFFICIENT

CC MO014CC 2,2

PACKAGING

L: 500 mm
 D: 70 mm
 H: 50 mm
 0,5 kg

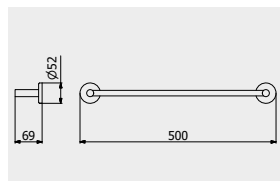

ARTICLE | ARTICOLO | ARTICLE

MO006

Towel holder

Porta salvietta

Porte-serviette

CODE / COEFFICIENT | CODICE /
COEFFICIENTE | CODE / COEFFICIENT

CC MO006CC 2,1

PACKAGING

L: 350 mm
 D: 70 mm
 H: 50 mm
 0,4 kg

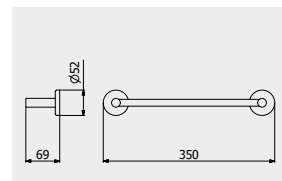

ARTICLE | ARTICOLO | ARTICLE

MO007

Ring Towel holder

Porta salvietta ad anello

Porte-serviettes anneau

CODE / COEFFICIENT | CODICE /
COEFFICIENTE | CODE / COEFFICIENT

CC MO007CC 1,6

PACKAGING

L: 180 mm 0,8 kg
D: 70 mm
H: 200 mm

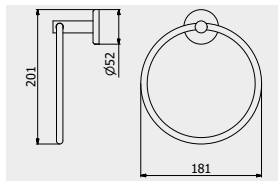

ARTICLE | ARTICOLO | ARTICLE

MO008

Robe Hook

Appendino a parete

Cintre

CODE / COEFFICIENT | CODICE /
COEFFICIENTE | CODE / COEFFICIENT

CC MO008CC 0,9

PACKAGING

L: 50 mm 0,3 kg
D: 50 mm
H: 50 mm

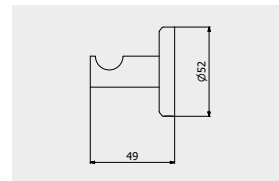

ARTICLE | ARTICOLO | ARTICLE

MO009

Double robe hook

Doppio appendino a parete

Double cintre

CODE / COEFFICIENT | CODICE /
COEFFICIENTE | CODE / COEFFICIENT

CC MO009CC 1,4

PACKAGING

L: 70 mm 0,1 kg
D: 70 mm
H: 50 mm

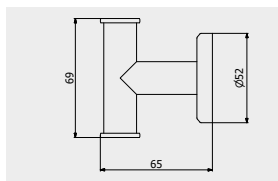

ARTICLE | ARTICOLO | ARTICLE

MO010

Shelf

Mensola

Etagère

CODE / COEFFICIENT | CODICE /
COEFFICIENTE | CODE / COEFFICIENT

CC MO010CC 3,0

PACKAGING

L: 600 mm 0,3 kg
D: 140 mm
H: 50 mm

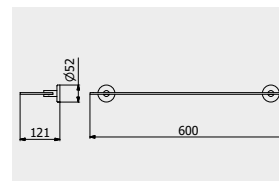

ARTICLE | ARTICOLO | ARTICLE

MO005

Swiveable towel holder

Porta salvietta doppio

Porte-serviettes noeud

CODE / COEFFICIENT | CODICE /
COEFFICIENTE | CODE / COEFFICIENT

CC MO005CC 3,5

PACKAGING

L: 430 mm 0,5 kg
D: 70 mm
H: 50 mm

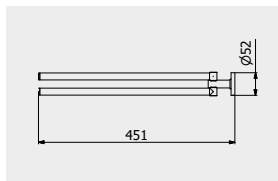

ARTICLE | ARTICOLO | ARTICLE

MO011

Toilet paper holder

Porta rotolo

Porte rouleaux de toilette

CODE / COEFFICIENT | CODICE /
COEFFICIENTE | CODE / COEFFICIENT

CC MO011CC 1,4

PACKAGING

L: 150 mm 0,2 kg
D: 70 mm
H: 50 mm

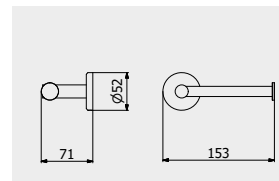

ARTICLE | ARTICOLO | ARTICLE

MO012

Toilet brush holder

Porta scopino da terra

Porte balayette au sol

CODE / COEFFICIENT | CODICE /
COEFFICIENTE | CODE / COEFFICIENT

CC MO012CC 2,5

PACKAGING

L: 80 mm 0,7 kg
D: 80 mm
H: 380 mm

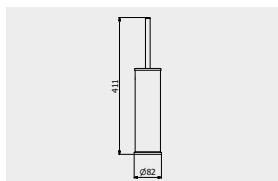

ARTICLE | ARTICOLO | ARTICLE

MO013

Wall toilet brush holder

Porta scopino da parete

Porte balayette

CODE / COEFFICIENT | CODICE /
COEFFICIENTE | CODE / COEFFICIENT

CC MO013CC 2,9

PACKAGING

L: 80 mm 0,7 kg
D: 80 mm
H: 380 mm

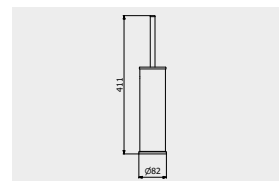

K3

Sharp and essential outlines is the language of elegance.

Contorni netti ed essenziali sono il linguaggio dell'eleganza.
Les contours nets et essentiels sont le langage de l'élégance.

K3 incorporates the elegance and sobriety of the K2 twin collection, but with a slightly sharper cut, thanks to the square shapes at the base and in the lever that add a touch of unpredictability and character to a collection still recognizable for its refinement and its aesthetic measure.

K3 riprende l'eleganza e la sobrietà della linea gemella K2, ma con un taglio leggermente più deciso, dalle forme squadrate alla base e nella leva del rubinetto che aggiungono un tocco di imprevedibilità e carattere a un serie sempre riconoscibile per la sua eleganza e misura estetica.

K3 incorpore l'élégance et la sobriété de la ligne jumelle K2, mais avec une touche légèrement plus résolu, avec ses formes carrées à la base et au levier qui ajoutent une touche d'imprévisibilité et de caractère à une série toujours reconnaissable pour son élégance et sa mesure esthétique.



ANTI-LIMESCALE



CRYSTAL CLEAR
WATER



LEAD FREE



ZINC FREE







- ↑ **K3209CC**
 Monohole wall mounted washbasin mixer
 Miscelatore lavabo a parete monoforo
 Mitigeur lavabo mural monotrou
- ← **K3202CC**
 Tall monohole washbasin mixer
 Miscelatore lavabo monoforo alto
 Mitigeur lavabo haut
- **K3200CC**
 Monohole washbasin mixer
 Miscelatore lavabo monoforo
 Mitigeur lavabo







K3

← **K3200NP**
Monohole washbasin mixer
Miscelatore lavabo monoforo
Mitigeur lavabo

↑ **K3200NP**
Monohole washbasin mixer
Miscelatore lavabo monoforo
Mitigeur lavabo

K3300NP
One way wall shower mixer
Miscelatore doccia a parete una via
Mitigeur douche mural une voie

→ **K3314CC**
Three ways wall shower mixer complete with shower kit
Miscelatore doccia a parete con deviatore tre vie e doccia integrato
Mitigeur douche mural trois voies avec inverseur et douchette encastrée







K3

← K3202NP
Tall monohole washbasin mixer
Miscelatore lavabo monoforo alto
Mitigeur lavabo haut

↗ K3299CC
Monohole free-standing washbasin mixer
Miscelatore lavabo da terra
Mitigeur lavabo free standing



↑ **K3250CC**
Wall mounted bath filler with hand shower kit
Bordo vasca esterno a parete di kit doccia
Mitigeur Bain/douche Mural avec douchette
encastrée

→ **K3800CC**
Shower column with mixer and shower kit
Colonna doccia con miscelatore e e kit doccia
Colonne de douche avec mitigeur et kit douche

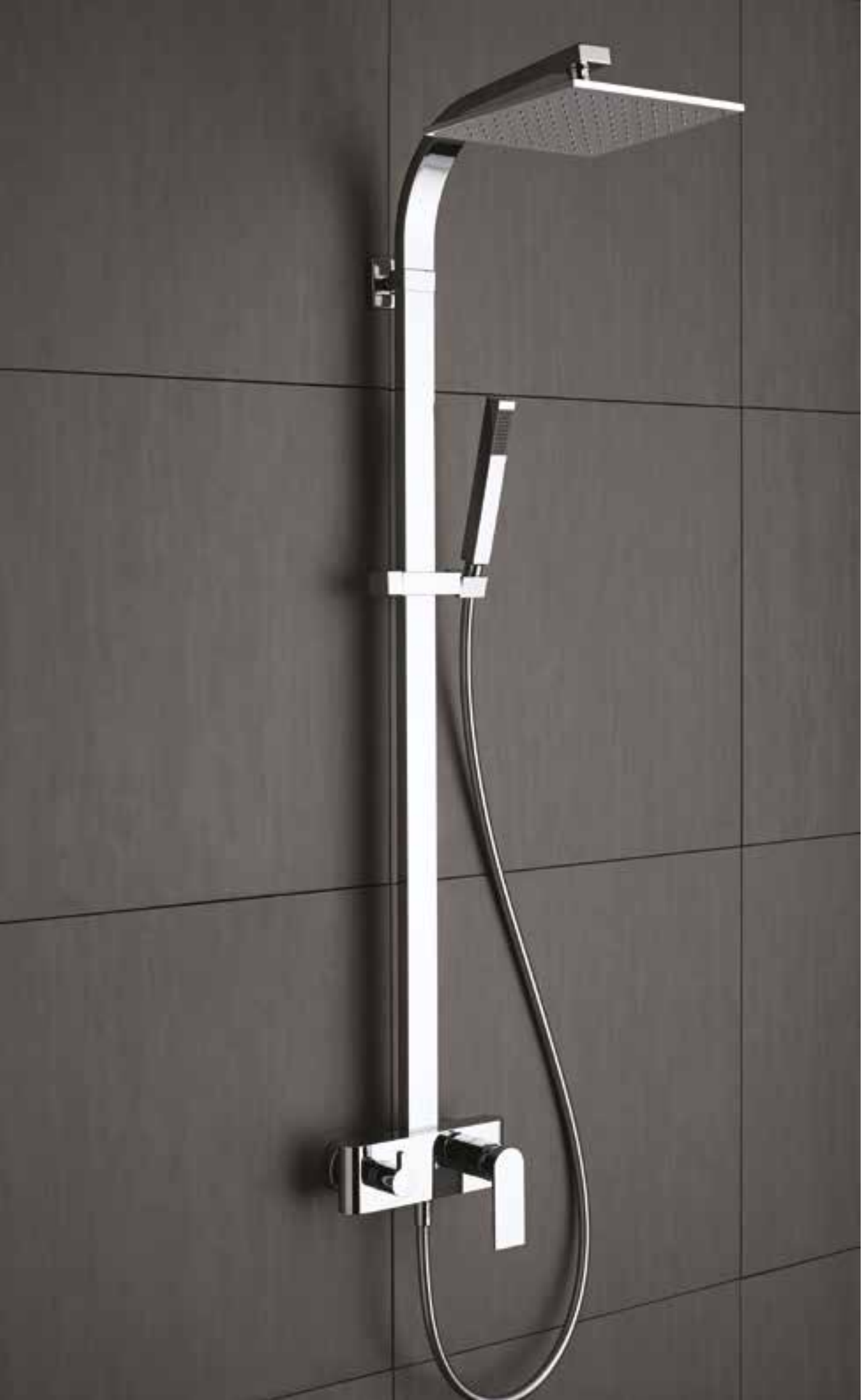

ARTICLE | ARTICOLO | ARTICLE

K3200



Monohole washbasin mixer complete with drain

Miscelatore lavabo monoforo completo di scarico automatico

Mitigeur lavabo complet avec bonde automatique

CODICE / COEFFICIENTE CODE / COEFFICIENT		PACKAGING
● CC	K3200CC	7,7
● SS	K3200SS	9,6
● BO	K3200BO	9,2
● NP	K3200NP	9,2
● II	K3200II	11,6
● IS	K3200IS	12,3
● RS	K3200RS	11,6
● OO	K3200OO	11,6

PACKAGING

L: 340 mm
D: 180 mm
H: 70 mm

2,0 kg

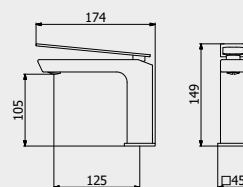

PORTATE | WATER FLOW | DÉBIT D'EAU

1 BAR	2 BAR	3 BAR
3,5 l/m	4,8 l/m	5,2 l/m

ARTICLE | ARTICOLO | ARTICLE

K3201



Mini monohole washbasin mixer complete with drain

Miscelatore lavabo monoforo mini completo di scarico automatico

Mitigeur lavabo mini complet avec bonde automatique

CODICE / COEFFICIENTE CODE / COEFFICIENT		PACKAGING
● CC	K3201CC	6,4
● SS	K3201SS	8,0
● BO	K3201BO	7,7
● NP	K3201NP	7,7
● II	K3201II	9,6
● IS	K3201IS	10,2
● RS	K3201RS	9,6
● OO	K3201OO	9,6

PACKAGING

L: 340 mm
D: 180 mm
H: 70 mm

1,8 kg

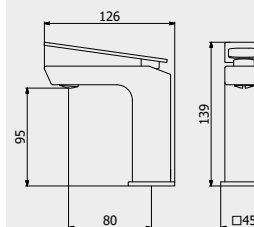

PORTATE | WATER FLOW | DÉBIT D'EAU

1 BAR	2 BAR	3 BAR
3,9 l/m	4,9 l/m	5,4 l/m

ARTICLE | ARTICOLO | ARTICLE

K3202



Tall monohole washbasin mixer complete with drain

Miscelatore lavabo monoforo alto completo di scarico automatico

Mitigeur lavabo haut complet avec bonde automatique

CODICE / COEFFICIENTE CODE / COEFFICIENT		PACKAGING
● CC	K3202CC	11,1
● SS	K3202SS	13,9
● BO	K3202BO	13,3
● NP	K3202NP	13,3
● II	K3202II	16,7
● IS	K3202IS	17,8
● RS	K3202RS	16,7
● OO	K3202OO	16,7

PACKAGING

L: 370 mm
D: 270 mm
H: 80 mm

2,7 kg

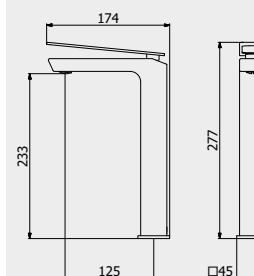

PORTATE | WATER FLOW | DÉBIT D'EAU

1 BAR	2 BAR	3 BAR
3,6 l/m	4,8 l/m	5,2 l/m



ARTICLE | ARTICOLO | ARTICLE

K3209



Monohole wall mounted washbasin mixer

Miscelatore lavabo a parete monoforo

Mitigeur lavabo mural monotrou

CODICE / COEFFICIENTE CODE / COEFFICIENT	
CC	K3209CC 10,8
SS	K3209SS 13,5
BO	K3209BO 13,0
NP	K3209NP 13,0
II	K3209II 16,2
IS	K3209IS 17,3
RS	K3209RS 16,2
OO	K3209OO 16,2

PACKAGING

L: 425 mm
D: 188 mm
H: 98 mm

3,5 kg

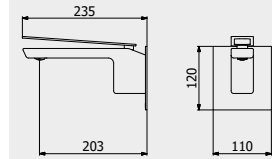

PORTATE | WATER FLOW | DÉBIT D'EAU

1 BAR	2 BAR	3 BAR
3,9 l/m	5 l/m	5,2 l/m

K3

ARTICLE | ARTICOLO | ARTICLE

K3210



Ceiling spout with wall mounted mixer

Bocca da soffitto con comando remoto ad incasso

Mitigeur lavabo mural avec bec plafond complet avec bonde automatique

CODICE / COEFFICIENTE CODE / COEFFICIENT	
CC	EK3210CC 33,8
SS	EK3210SS 42,3
BO	EK3210BO 40,6
NP	EK3210NP 40,6

PACKAGING

L: 150 mm
D: 190 mm
H: 98 mm

L: 1700 mm
Ø: 70 mm

4,5 kg

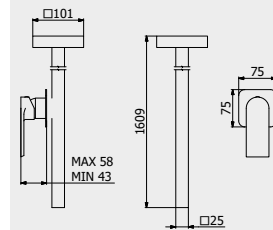
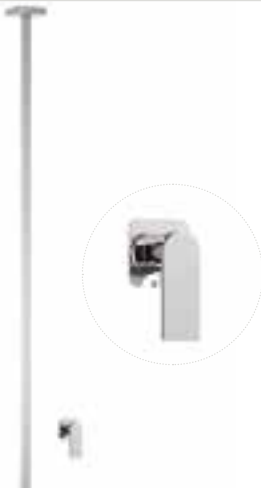

PORTATE | WATER FLOW | DÉBIT D'EAU

1 BAR	2 BAR	3 BAR
4,3 l/m	5,2 l/m	7 l/m

Built-in body to be purchased separately

Corpo incasso da acquistare separatamente

Corps intégré à acheter séparément



CODICE | CODE | CODE

INC300XXXN_19

COEFFICIENTE | COEFFICIENT | COEFFICIENT

1,8



ARTICLE | ARTICOLO | ARTICLE

K3299



Monohole free-standing washbasin mixer complete with drain
 Miscelatore lavabo da terra completo di scarico automatico
 Mitigeur lavabo free standing complet avec bonde automatique

CODICE / COEFFICIENTE	CODE / COEFFICIENT	
CC	EK3299CC	30,7
SS	EK3299SS	38,4
BO	EK3299BO	36,8
NP	EK3299NP	36,8
II	EK3299II	46,1
IS	EK3299IS	49,1
RS	EK3299RS	46,1
OO	EK3299OO	46,1

PACKAGING

L: 1160 mm
D: 360 mm
H: 180 mm

11,2 kg

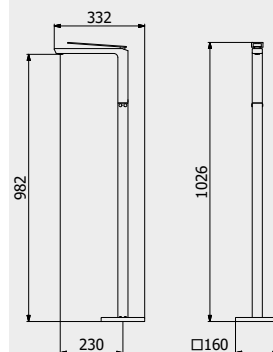

PORTATE | WATER FLOW | DÉBIT D'EAU

1 BAR	2 BAR	3 BAR
3,6 l/m	5,1 l/m	5,5 l/m

Built-in body to be purchased separately
 AVAILABLE FROM JANUARY 2020

Corpo incasso da acquistare separatamente
 DISPONIBILE DA GENNAIO 2020
 Corps intégré à acheter séparément
 DISPONIBLE À PARTIR DE JANVIER 2020



CODICE | CODE | CODE

INC399XXXN_19

COEFFICIENTE | COEFFICIENT | COEFFICIENT

2,8

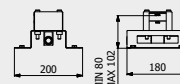

ARTICLE | ARTICOLO | ARTICLE

K3220



Monohole bidet mixer complete with drain
 Miscelatore bidet monoforo completo di scarico automatico
 Mitigeur bidet complet avec bonde automatique

CODICE / COEFFICIENTE	CODE / COEFFICIENT	
CC	K3220CC	6,6
SS	K3220SS	8,3
BO	K3220BO	7,9
NP	K3220NP	7,9
II	K3220II	9,9
IS	K3220IS	10,6
RS	K3220RS	9,9
OO	K3220OO	9,8

PACKAGING

L: 340 mm
D: 180 mm
H: 70 mm

1,9 kg

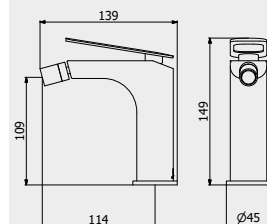

PORTATE | WATER FLOW | DÉBIT D'EAU

1 BAR	2 BAR	3 BAR
3,5 l/m	4,9 l/m	5,4 l/m

ARTICLE | ARTICOLO | ARTICLE

K3300



Exposed parts for manual wall mixer
 Set di parti esterne per miscelatore a parete ad una via
 Partie extérieure pour mitigeur encastré à une voie

CODICE / COEFFICIENTE	CODE / COEFFICIENT	
CC	EK3300CC	4,1
SS	EK3300SS	5,1
BO	EK3300BO	4,9
NP	EK3300NP	4,9
II	EK3300II	6,2
IS	EK3300IS	6,6
RS	EK3300RS	6,2
OO	EK3300OO	6,2

PACKAGING

L: 150 mm
D: 190 mm
H: 98 mm

1,8 kg

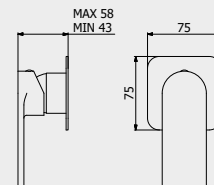

PORTATE | WATER FLOW | DÉBIT D'EAU

1 BAR	2 BAR	3 BAR
11,5 l/m	16,3 l/m	20 l/m

Built-in body to be purchased separately

Corpo incasso da acquistare separatamente
 Corps intégré à acheter séparément



CODICE | CODE | CODE

INC300XXXN_19

COEFFICIENTE | COEFFICIENT | COEFFICIENT

1,8

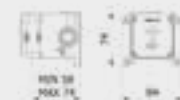

ARTICLE | ARTICOLO | ARTICLE

K3310



Exposed parts for manual wall mixer with two ways diverter
 Miscelatore doccia a parete con deviatore due vie
 Mitigeur douche mural deux voies avec inverseur

CODICE / COEFFICIENTE CODE / COEFFICIENT	
CC	EK3310CC 6,1
SS	EK3310SS 7,6
BO	EK3310BO 7,3
NP	EK3310NP 7,3
II	EK3310II 9,2
IS	EK3310IS 9,8
RS	EK3310RS 9,2
OO	EK3310OO 9,2

PACKAGING
 L: 150 mm
 D: 190 mm
 H: 98 mm
 1,8 kg

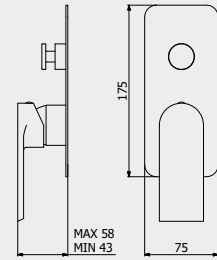

PORTATE | WATER FLOW | DÉBIT D'EAU

1 BAR	2 BAR	3 BAR
9,2 l/m	12,5 l/m	16 l/m

K3

Built-in body to be purchased separately
 Corpo incasso da acquistare separatamente
 Corps intégré à acheter séparément



CODICE | CODE | CODE

INC310XXXN_19

COEFFICIENTE | COEFFICIENT | COEFFICIENT

3,3

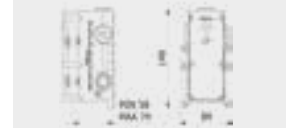

ARTICLE | ARTICOLO | ARTICLE

K3312



Exposed parts for manual wall mixer with three ways diverter
 Set di parti esterne per miscelatore a parete a tre vie
 Mitigeur douche mural trois voies avec inverseur

CODICE / COEFFICIENTE CODE / COEFFICIENT	
CC	EK3312CC 7,4
SS	EK3312SS 9,3
BO	EK3312BO 8,9
NP	EK3312NP 8,9
II	EK3312II 11,1
IS	EK3312IS 11,8
RS	EK3312RS 11,1
OO	EK3312OO 11,1

PACKAGING
 L: 150 mm
 D: 190 mm
 H: 98 mm
 1,8 kg

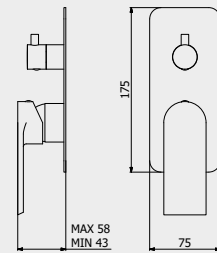

PORTATE | WATER FLOW | DÉBIT D'EAU

1 BAR	2 BAR	3 BAR
8,3 l/m	11,7 l/m	14,3 l/m

Built-in body to be purchased separately
 Corpo incasso da acquistare separatamente
 Corps intégré à acheter séparément



CODICE | CODE | CODE

INC312XXXN_19

COEFFICIENTE | COEFFICIENT | COEFFICIENT

3,3



ARTICLE | ARTICOLO | ARTICLE

K3313



Exposed parts for manual wall mixer with 2 ways with shower kit
 Set di parti esterne per miscelatore a parete a due vie completo di kit doccia
 Partie extérieure pour mitigeur encastré à deux voies avec douchette

CODICE / COEFFICIENTE CODE / COEFFICIENT	
CC	EK3313CC 10,1
SS	EK3313SS 12,6
BO	EK3313BO 12,1
NP	EK3313NP 12,1
II	EK3313II 15,2
IS	EK3313IS 16,2
RS	EK3313RS 15,2
OO	EK3313OO 15,2

PACKAGING
 L: 370 mm
 D: 270 mm
 H: 80 mm
 2,2 kg

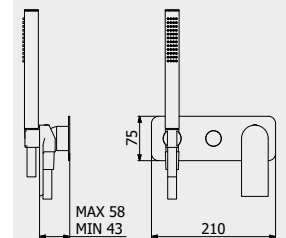

PORTATE | WATER FLOW | DÉBIT D'EAU

1 BAR	2 BAR	3 BAR
10 l/m	14,1 l/m	17,2 l/m

Built-in body to be purchased separately
 Corpo incasso da acquistare separatamente
 Corps intégré à acheter séparément



CODICE | CODE | CODE

INC313XXXN_19

COEFFICIENTE | COEFFICIENT | COEFFICIENT

3,6

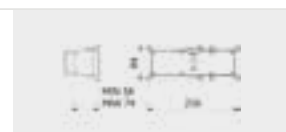

ARTICLE | ARTICOLO | ARTICLE

K3314



Exposed parts for manual wall mixer with 3 ways with shower kit
Set di parti esterne per miscelatore a parete a tre vie completo di kit doccia
Partie extérieure pour mitigeur encastré à trois voies avec douchette

CODICE / COEFFICIENTE	CODE / COEFFICIENT	
● CC	EK3314CC	11,4
● SS	EK3314SS	14,3
● BO	EK3314BO	13,7
● NP	EK3314NP	13,7
● II	EK3314II	17,1
● IS	EK3314IS	18,2
● RS	EK3314RS	17,1
● OO	EK3314OO	17,1

PACKAGING

L: 370 mm
D: 270 mm
H: 80 mm

2,2 kg

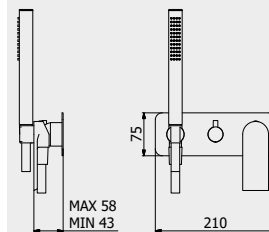

PORTATE | WATER FLOW | DÉBIT D'EAU

1 BAR	2 BAR	3 BAR
8,3 l/m	11,7 l/m	14,3 l/m

Built-in body to be purchased separately

Corpo incasso da acquistare separatamente

Corps intégré à acheter séparément



CODICE | CODE | CODE

INC314XXXN_19

COEFFICIENTE | COEFFICIENT | COEFFICIENT

3,7

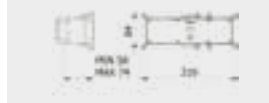

ARTICLE | ARTICOLO | ARTICLE

K3350



Wall mounted shower mixer with shower kit

Doccia esterno a parete completo di kit doccia

Mitigeur de douche externe avec flexible et douchette

CODICE / COEFFICIENTE	CODE / COEFFICIENT	
● CC	K3350CC	11,1
● SS	K3350SS	13,9
● BO	K3350BO	13,3
● NP	K3350NP	13,3
● II	K3350II	16,7
● IS	K3350IS	17,8
● RS	K3350RS	16,7
● OO	K3350OO	16,7

PACKAGING

L: 360 mm
D: 220 mm
H: 150 mm

3,5 kg

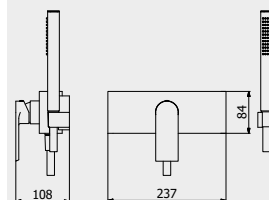

PORTATE | WATER FLOW | DÉBIT D'EAU

1 BAR	2 BAR	3 BAR
11,5 l/m	18,4 l/m	23,3 l/m

ARTICLE | ARTICOLO | ARTICLE

K3800



Shower column with mixer and shower kit

Colonna doccia con miscelatore e e kit doccia

Colonne de douche avec mitigeur et kit douche

CODICE / COEFFICIENTE	CODE / COEFFICIENT	
● CC	K3800CC	27,6

PACKAGING

L: 1200 mm
D: 400 mm
H: 170 mm

11,6 kg

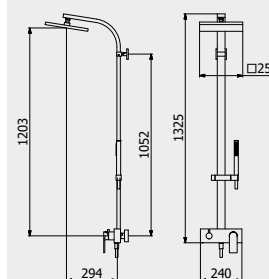

PORTATE | WATER FLOW | DÉBIT D'EAU

1 BAR	2 BAR	3 BAR
9 l/m	12 l/m	14,5 l/m



ARTICLE | ARTICOLO | ARTICLE

K3399



Free-standing bath filler with shower kit

Bordo vasca da terra con kit doccia

Bain douche complet alimentation au sol

CODICE / COEFFICIENTE	CODE / COEFFICIENT	
CC	EK3399CC	41,0
SS	EK3399SS	51,3
BO	EK3399BO	49,2
NP	EK3399NP	49,2
II	EK3399II	61,5
IS	EK3399IS	65,6
RS	EK3399RS	61,5
OO	EK3399OO	61,5

PACKAGING

L: 1160 mm
D: 360 mm
H: 180 mm

14 kg

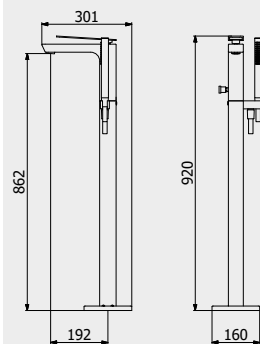

PORTATE | WATER FLOW | DÉBIT D'EAU

1 BAR	2 BAR	3 BAR
13,6 l/m	19,6 l/m	24 l/m

K3

Built-in body to be purchased separately
AVAILABLE FROM JANUARY 2020
Corpo incasso da acquistare separatamente
DISPONIBILE DA GENNAIO 2020
Corps intégré à acheter séparément
DISPONIBLE À PARTIR DE JANVIER 2020



CODICE | CODE | CODE

INC399XXXN_19

COEFFICIENTE | COEFFICIENT | COEFFICIENT

2,8

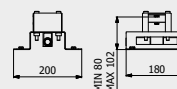

ARTICLE | ARTICOLO | ARTICLE

K3250



Wall mounted bath filler complete with hand shower kit

Bordo vasca esterno a parete completo di kit doccia

Mitigeur Bain/douche Mural avec douchette encastrée

CODICE / COEFFICIENTE	CODE / COEFFICIENT	
CC	K3250CC	13,9
SS	K3250SS	17,4
BO	K3250BO	16,7
NP	K3250NP	16,7
II	K3250II	20,9
IS	K3250IS	20,9
RS	K3250RS	22,2
OO	K3250OO	20,9

PACKAGING

L: 353 mm
D: 225 mm
H: 226 mm

4,9 kg

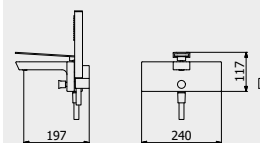

PORTATE | WATER FLOW | DÉBIT D'EAU

1 BAR	2 BAR	3 BAR
9,2 l/m	14,2 l/m	17,6 l/m

ARTICLE | ARTICOLO | ARTICLE

RU319



Wall mounted waterfall

Cascata a parete con erogazione diretta

Cascade murale

CODICE / COEFFICIENTE	CODE / COEFFICIENT	
CC	RU319CC	12,8
SS	RU319SS	16,0
BO	RU319BO	15,4
NP	RU319NP	15,4
CF	RU319CF	19,2
CS	RU319CS	20,5
II	RU319II	19,2
IS	RU319IS	20,5
RS	RU319RS	19,2
SR	RU319SR	20,5
OO	RU319OO	19,2
OS	RU319OS	20,5

PACKAGING

L: 340 mm
D: 180 mm
H: 70 mm

3,1 kg

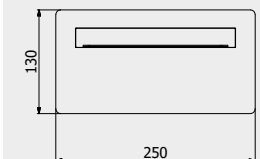

PORTATE | WATER FLOW | DÉBIT D'EAU

1 BAR	2 BAR	3 BAR
13 l/m	17 l/m	20 l/m

ARTICLE | ARTICOLO | ARTICLE

RU320



Wall mounted spout

Bocca d'erogazione corta a parete

Bec de remplissage mural court

CODICE / COEFFICIENTE | CODE /
COEFFICIENT | CODE / COEFFICIENT

● CC	RU320CC	2,5
● SS	RU320SS	3,1
● BO	RU320BO	3,0
● NP	RU320NP	3,0
● II	RU320II	3,8
● IS	RU320IS	4,0
● RS	RU320RS	3,8
● OO	RU320OO	3,8

PACKAGING

L: 210 mm
D: 130 mm
H: 70 mm

1,5 kg

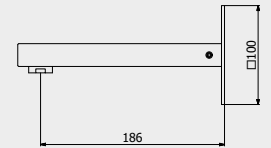

PORTATE | WATER FLOW | DÉBIT D'EAU

1 BAR	2 BAR	3 BAR
15 l/m	19 l/m	24 l/m

ARTICLE | ARTICOLO | ARTICLE

RU321



Short wall mounted spout

Bocca d'erogazione corta a parete

Bec de remplissage mural court

CODICE / COEFFICIENTE | CODE /
COEFFICIENT | CODE / COEFFICIENT

● CC	RU321CC	3,0
● SS	RU321SS	3,8
● BO	RU321BO	3,6
● NP	RU321NP	3,6
● II	RU321II	4,5
● IS	RU321IS	4,8
● RS	RU321RS	4,5
● OO	RU321OO	4,5

PACKAGING

L: 210 mm
D: 130 mm
H: 70 mm

1,4 kg

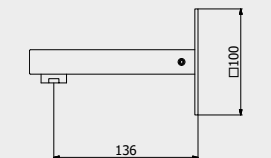

PORTATE | WATER FLOW | DÉBIT D'EAU

1 BAR	2 BAR	3 BAR
15 l/m	19 l/m	24 l/m

ARTICLE | ARTICOLO | ARTICLE

RU322



Long wall mounted spout

Bocca d'erogazione lunga a parete

Bec de remplissage mural long

CODICE / COEFFICIENTE | CODE /
COEFFICIENT | CODE / COEFFICIENT

● CC	RU322CC	3,0
● SS	RU322SS	3,8
● BO	RU322BO	3,6
● NP	RU322NP	3,6
● II	RU322II	4,5
● IS	RU322IS	4,5
● RS	RU322RS	4,8
● OO	RU322OO	4,5

PACKAGING

L: 210 mm
D: 130 mm
H: 70 mm

1,5 kg

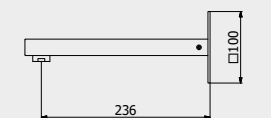

PORTATE | WATER FLOW | DÉBIT D'EAU

1 BAR	2 BAR	3 BAR
15 l/m	19 l/m	24 l/m



ARTICLE | ARTICOLO | ARTICLE

K3706



Exposed parts for bidet spray complete with mixer

Set di parti esterne per Idroscopino igienico con miscelatore

Partie extérieure pour douchette hygiénique avec mitigeur



CODE / COEFFICIENT	CODICE / COEFFICIENTE	COEFFICIENT
CC	EK3706CC	9,8
SS	EK3706SS	12,3
BO	EK3706BO	11,8
NP	EK3706NP	11,8
II	EK3706II	14,7
IS	EK3706IS	15,7
RS	EK3706RS	14,7
OO	EK3706OO	14,7

PACKAGING

L: 370 mm
D: 270 mm
H: 80 mm

3,2 kg

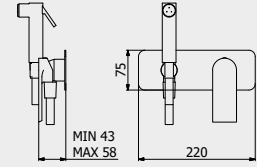

PORTATE | WATER FLOW | DÉBIT D'EAU

1 BAR	2 BAR	3 BAR
2,3 l/m	3,2 l/m	4 l/m

K3

Built-in body to be purchased separately

Corpo incasso da acquistare separatamente

Corps intégré à acheter séparément



CODICE | CODE | CODE

INC206XXXN_19

COEFFICIENTE | COEFFICIENT | COEFFICIENT

2,9

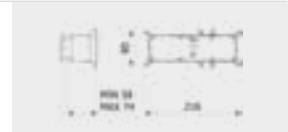

MODERNA / ACCESSORIES COLLECTION

ARTICLE | ARTICOLO | ARTICLE

MO001

Wall soap-holder

Porta sapone a muro

Porte distributeur de savon encastré

CODE / COEFFICIENT | CODICE /
COEFFICIENTE | CODE / COEFFICIENT

CC MO001CC 1,5

PACKAGING

L: 110 mm
 D: 130 mm
 H: 50 mm
 0,4 kg

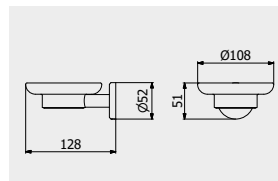

ARTICLE | ARTICOLO | ARTICLE

MO002

Wall soap dispenser holder

Porta dispenser sapone liquido a parete

Porte distributeur de savon en verre gravé

CODE / COEFFICIENT | CODICE /
COEFFICIENTE | CODE / COEFFICIENT

CC MO002CC 2,3

PACKAGING

L: 80 mm
 D: 130 mm
 H: 180 mm
 0,1 kg

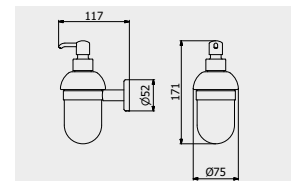

ARTICLE | ARTICOLO | ARTICLE

MO003

Wall toothbrush holder

Bicchieri porta spazzolino a parete

Porte-verre en verre gravé

CODE / COEFFICIENT | CODICE /
COEFFICIENTE | CODE / COEFFICIENT

CC MO003CC 1,5

PACKAGING

L: 70 mm
 D: 110 mm
 H: 100 mm
 0,4 kg

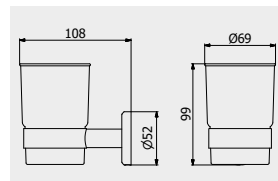

ARTICLE | ARTICOLO | ARTICLE

MO004

Towel holder

Porta salvietta

Porte-serviette

CODE / COEFFICIENT | CODICE /
COEFFICIENTE | CODE / COEFFICIENT

CC MO004CC 2,4

PACKAGING

L: 650 mm
 D: 70 mm
 H: 50 mm
 0,5 kg

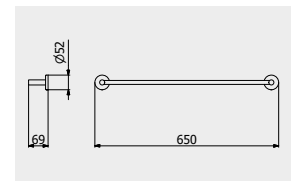

ARTICLE | ARTICOLO | ARTICLE

MO014

Towel holder

Porta salvietta

Porte-serviette

CODE / COEFFICIENT | CODICE /
COEFFICIENTE | CODE / COEFFICIENT

CC MO014CC 2,2

PACKAGING

L: 500 mm
 D: 70 mm
 H: 50 mm
 0,5 kg

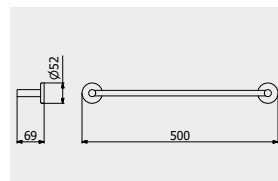

ARTICLE | ARTICOLO | ARTICLE

MO006

Towel holder

Porta salvietta

Porte-serviette

CODE / COEFFICIENT | CODICE /
COEFFICIENTE | CODE / COEFFICIENT

CC MO006CC 2,1

PACKAGING

L: 350 mm
 D: 70 mm
 H: 50 mm
 0,4 kg

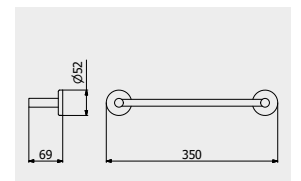

ARTICLE | ARTICOLO | ARTICLE

MO007

Ring Towel holder

Porta salvietta ad anello

Porte-serviettes anneau

CODE / COEFFICIENT | CODICE /
COEFFICIENTE | CODE / COEFFICIENT

CC **MO007CC** 1,6

PACKAGING

L: 180 mm 0,8 kg
D: 70 mm
H: 200 mm

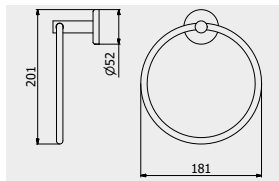

ARTICLE | ARTICOLO | ARTICLE

MO008

Robe Hook

Appendino a parete

Cintre

CODE / COEFFICIENT | CODICE /
COEFFICIENTE | CODE / COEFFICIENT

CC **MO008CC** 0,9

PACKAGING

L: 50 mm 0,3 kg
D: 50 mm
H: 50 mm

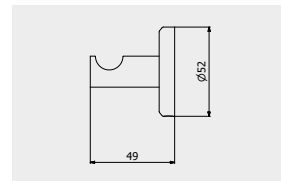

ARTICLE | ARTICOLO | ARTICLE

MO009

Double robe hook

Doppio appendino a parete

Double cintre

CODE / COEFFICIENT | CODICE /
COEFFICIENTE | CODE / COEFFICIENT

CC **MO009CC** 1,4

PACKAGING

L: 70 mm 0,1 kg
D: 70 mm
H: 50 mm

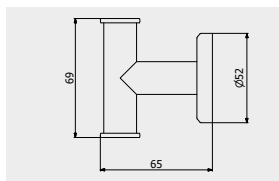

ARTICLE | ARTICOLO | ARTICLE

MO010

Shelf

Mensola

Etagère

CODE / COEFFICIENT | CODICE /
COEFFICIENTE | CODE / COEFFICIENT

CC **MO010CC** 3,0

PACKAGING

L: 600 mm 0,3 kg
D: 140 mm
H: 50 mm

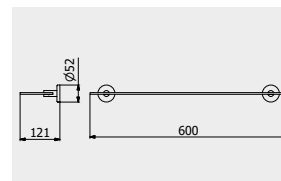

ARTICLE | ARTICOLO | ARTICLE

MO005

Swiveable towel holder

Porta salvietta doppio

Porte-serviettes noeud

CODE / COEFFICIENT | CODICE /
COEFFICIENTE | CODE / COEFFICIENT

CC **MO005CC** 3,5

PACKAGING

L: 430 mm 0,5 kg
D: 70 mm
H: 50 mm

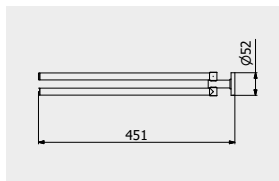

ARTICLE | ARTICOLO | ARTICLE

MO011

Toilet paper holder

Porta rotolo

Porte rouleaux de toilette

CODE / COEFFICIENT | CODICE /
COEFFICIENTE | CODE / COEFFICIENT

CC **MO011CC** 1,4

PACKAGING

L: 150 mm 0,2 kg
D: 70 mm
H: 50 mm

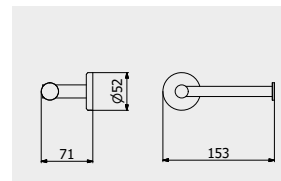

ARTICLE | ARTICOLO | ARTICLE

MO012

Toilet brush holder

Porta scopino da terra

Porte balayette au sol

CODE / COEFFICIENT | CODICE /
COEFFICIENTE | CODE / COEFFICIENT

CC **MO012CC** 2,5

PACKAGING

L: 80 mm 0,7 kg
D: 80 mm
H: 380 mm

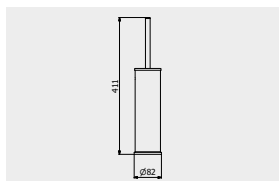

ARTICLE | ARTICOLO | ARTICLE

MO013

Wall toilet brush holder

Porta scopino da parete

Porte balayette

CODE / COEFFICIENT | CODICE /
COEFFICIENTE | CODE / COEFFICIENT

CC **MO013CC** 2,9

PACKAGING

L: 80 mm 0,7 kg
D: 80 mm
H: 380 mm

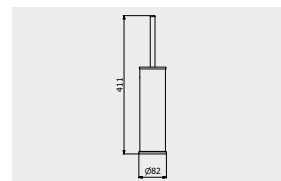

LOVEME

The spontaneous downpour of a small domestic waterfall.

Lo scrosciare spontaneo di una piccola cascata domestica.
Le crépitement spontané d'une petite cascade domestique.

To love means, first and foremost, to take care of oneself, starting from our daily home life. The LOVE ME collection enhances the free flow of water by replacing the directed jet with the spontaneous downpour of a small domestic waterfall. The water flows in a soft and natural outflow, like spouting directly from its source, thus combining aesthetic purity and genuine authenticity.

Amare significa anzitutto avere cura di sé, a partire dalla propria quotidianità casalinga. La serie LOVE ME esalta il flusso libero dell'acqua, sostituendo il getto direzionato con lo scrosciare spontaneo di una piccola cascata domestica. L'acqua scorre in un efflusso morbido e naturale, come sgorgando direttamente dalla sua fonte, coniugando così purezza estetica e genuina spontaneità.

Aimer, c'est d'abord prendre soin de soi-même, à partir de la vie quotidienne et domestique. La série LOVE ME glorifie le libre écoulement de l'eau en remplaçant le jet dirigé par le crépitement spontané d'une petite cascade domestique. L'eau s'écoule de manière douce et naturelle, comme si elle jaillissait directement de sa source, alliant ainsi pureté esthétique et spontanéité authentique.



LEAD FREE



ZINC FREE



CASCADE



Loveme



DESIGN
MAURIZIO DURANTI

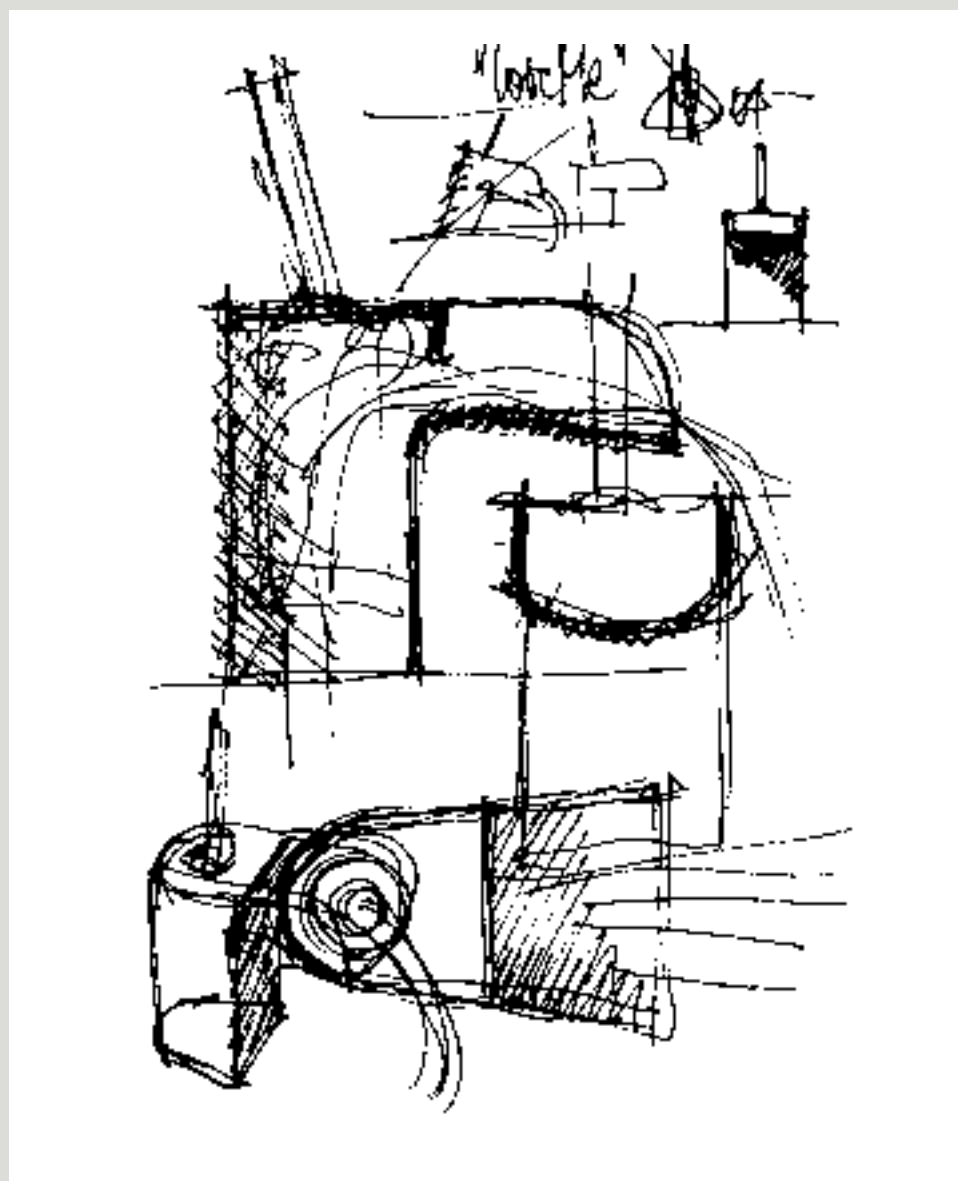

Self-care through the pleasure of a small waterfall, a synonym for life.

La cura di sé tramite il piacere di una piccola cascata d'acqua, sinonimo di vita.

Soin de soi, à travers le plaisir d'une petite cascade, synonyme de vie.

“ Loveme tell about my way of understanding design: narrative, simple, but also valuable and stimulating. Design must simultaneously create desires and satisfy functions. I find the English concept of “understatement” fascinating: the essence rather than the appearance, a low-key quality. Thus LOVE ME alludes to the more abstract concept of self-care through the pleasure of a small waterfall, a synonym for life. This collection, which is the one that gave me the biggest satisfaction and that gave birth to a new way of designing faucets. In hindsight, I think that LOVE ME is timeless.

Loveme racconta il mio modo di concepire il design: narrativo, semplice, ma anche prezioso e stimolante. Il design deve contemporaneamente creare desideri e soddisfare funzioni. Trovo affascinante il concetto inglese di “understatement”: l'essenza più che l'apparenza, il sottotono di qualità. Così LOVE ME allude a un concetto più astratto, la cura di sé tramite il piacere di una piccola cascata d'acqua, sinonimo di vita. Questa è la serie che mi ha dato più soddisfazioni e che ha dato vita a un nuovo modo di concepire i rubinetti. Con il senno del poi, penso che LOVE ME sia senza tempo.

Loveme raconte ma façon de concevoir le design: narratif, simple, mais aussi précieux et stimulant. Le design doit simultanément créer des désirs et satisfaire des fonctions. Je trouve fascinant le concept anglais de “understatement”: l'essence plutôt que l'aspect, le profil bas de qualité. Si LOVE ME fait allusion au concept plus abstrait du soin de soi, à travers le plaisir d'une petite cascade, synonyme de vie. C'est la série, celle qui m'a donné le plus de satisfaction et qui a créé une nouvelle façon de concevoir les robinets. Avec un peu de recul, je pense que LOVE ME est éternelle.

”

Maurizio Duranti design for LOVEME





Loveme

- ← LM200CC
Monohole washbasin mixer
Miscelatore lavabo monoforo
Mitigeur lavabo
- LM202CC
Tall monohole washbasin mixer
Miscelatore lavabo monoforo alto
Mitigeur lavabo haut
- ↘ LM200CC
Monohole washbasin mixer
Miscelatore lavabo monoforo
Mitigeur lavabo



- LM392CC
Three holes washbasin set with low spout
Lavabo tre fori a bocca bassa
Lavabo trois trous bec bas

- ↓ LM207CC
Wall mounted washbasin mixer with drain
Miscelatore lavabo due fori a parete
Mitigeur lavabo mural

- LM201CC
Mini monohole washbasin mixer
Miscelatore lavabo monoforo mini
Mitigeur lavabo Mini









← **LM314CC**
Three ways wall shower mixer complete with shower kit
Miscelatore doccia a parete con deviatore tre vie e doccino integrato
Mitigeur douche mural trois voies avec inverseur et douchette encastrée

↗ **LM350CC**
Wall mounted shower mixer with shower kit
Doccia esterno a parete di kit doccia
Mitigeur de douche externe avec flexible et douchette



- ← **LM750CC**
Deck mounted bath filler mixer
Miscelatore bordo vasca da appoggio
Mitigeur bain/douche
- ↓ **LM396CC**
Four holes deck mounted bath filler with shower kit
Bordo vasca quattro fori con deviatore e kit doccia
Bain/douche quatre trous avec inverseur et Kit Douche
- | | |
|---|---|
| A Hot water
Acqua calda
Eau chaude | C Cold water
Acqua fredda
Eau froide |
| B Spout with diverter
Bocca d'erogazione
con deviatore
Bec avec déviateur | D Hand shower
Doccino
Douchette |
- **LM250CC**
Wall mounted bath filler complete with hand shower kit
Bordo vasca esterno a parete completo di kit doccia
Mitigeur bain/douche mural avec douchette encastrée







↖ **LM250CC**
 Wall mounted bath filler complete with hand shower kit
 Bordo vasca esterno a parete completo di kit doccia
 Mitigeur bain/douche mural avec douchette encastrée

← **LM399CC**
 → Free-standing bath filler with shower kit
 Bordo vasca da terra con kit doccia
 Bain douche complet alimentation au sol

A	Miscelatore joystick	C	Diverter
	Joystick mixer		Deviatore
	Mélangeur de joystick		Déviateur
B	Hand shower		
	Doccino		
	Douchette		



ARTICLE | ARTICOLO | ARTICLE

LM200



Monohole washbasin mixer complete with drain

Miscelatore lavabo monoforo completo di scarico automatico

Mitigeur lavabo complet avec bonde automatique

CODE / COEFFICIENT | CODICE /
COEFFICIENTE | CODE / COEFFICIENT

● CC	LM200CC	9,8
● SS	LM200SS	12,3
● ON	LM200ON	9,8
● BO	LM200BO	11,8
● NP	LM200NP	11,8
● CS	LM200CS	14,7
● IS	LM200IS	15,7
● SR	LM200SR	15,7
● OS	LM200OS	15,7

PACKAGING

 L: 240 mm
D: 215 mm
H: 110 mm

2,9 kg

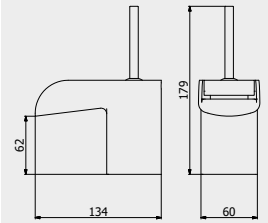

PORTATE | WATER FLOW | DÉBIT D'EAU

1 BAR	2 BAR	3 BAR
10 l/m	10,2 l/m	10,5 l/m

ARTICLE | ARTICOLO | ARTICLE

LM201



Mini monohole washbasin mixer complete with drain

Miscelatore lavabo monoforo mini completo di scarico automatico

Mitigeur lavabo mini complet avec bonde automatique

CODE / COEFFICIENT | CODICE /
COEFFICIENTE | CODE / COEFFICIENT

● CC	LM201CC	7,9
● SS	LM201SS	9,9
● BO	LM201BO	9,5
● NP	LM201NP	9,5

PACKAGING

 L: 340 mm
D: 180 mm
H: 70 mm

1,6 kg

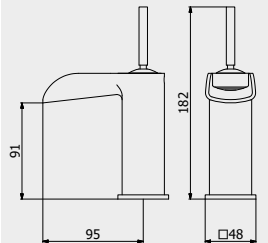

PORTATE | WATER FLOW | DÉBIT D'EAU

1 BAR	2 BAR	3 BAR
7 l/m	7 l/m	7,5 l/m

ARTICLE | ARTICOLO | ARTICLE

LM202



Tall monohole washbasin mixer complete with drain

Miscelatore lavabo monoforo alto completo di scarico automatico

Mitigeur lavabo haut complet avec bonde automatique

CODE / COEFFICIENT | CODICE /
COEFFICIENTE | CODE / COEFFICIENT

● CC	LM202CC	17,6
● SS	LM202SS	22,0
● ON	LM202ON	17,6
● BO	LM202BO	21,1
● NP	LM202NP	21,1
● CS	LM202CS	26,4
● IS	LM202IS	28,2
● SR	LM202SR	28,2
● OS	LM202OS	28,2

PACKAGING

 L: 455 mm
D: 310 mm
H: 75 mm

4,4 kg

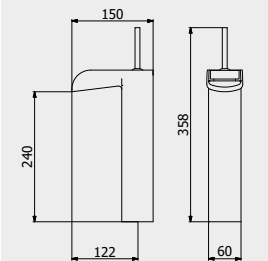

PORTATE | WATER FLOW | DÉBIT D'EAU

1 BAR	2 BAR	3 BAR
8 l/m	9 l/m	9,5 l/m

ARTICLE | ARTICOLO | ARTICLE

LM203



Tall mini monohole washbasin mixer complete with drain

Miscelatore lavabo monoforo alto mini completo di scarico automatico

Mitigeur lavabo haut mini complet avec bonde automatique

CODE / COEFFICIENT | CODICE /
COEFFICIENTE | CODE / COEFFICIENT

● CC	LM203CC	11,7
● SS	LM203SS	14,6
● BO	LM203BO	14,0
● NP	LM203NP	14,0

PACKAGING

 L: 425 mm
D: 188 mm
H: 98 mm

2,5 kg

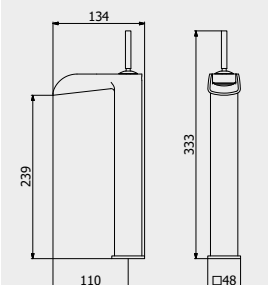

PORTATE | WATER FLOW | DÉBIT D'EAU

1 BAR	2 BAR	3 BAR
7 l/m	7 l/m	7,5 l/m



ARTICLE | ARTICOLO | ARTICLE

LM204



Mid-size monohole washbasin mixer complete with drain
 Miscelatore lavabo monoforo medio completo di scarico automatico
 Mitigeur lavabo moyen complet avec bonde automatique

CODE / COEFFICIENT	CODICE / COEFFICIENTE	COEFFICIENT
CC	LM204CC	11,8
SS	LM204SS	14,8
BO	LM204BO	14,2
NP	LM204NP	14,2
ON	LM204ON	11,8

PACKAGING

L: 425 mm
 D: 188 mm
 H: 98 mm
 3,4 kg

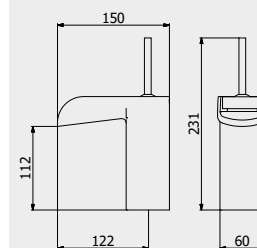

PORTATE | WATER FLOW | DÉBIT D'EAU

1 BAR	2 BAR	3 BAR
7,3 l/m	8,9 l/m	11,0 l/m

Love me

ARTICLE | ARTICOLO | ARTICLE

LM206



Wall mounted washbasin mixer complete with drain
 Miscelatore lavabo due fori a parete completo di scarico automatico
 Mitigeur lavabo mural complet avec bonde automatique

CODE / COEFFICIENT	CODICE / COEFFICIENTE	COEFFICIENT
CC	ELM206CC	12,8
SS	ELM206SS	16,0
ON	ELM206ON	12,8
BO	ELM206BO	15,4
NP	ELM206NP	15,4
CS	ELM206CS	19,2
IS	ELM206IS	20,5
SR	ELM206SR	20,5
OS	ELM206OS	20,5

PACKAGING

L: 275 mm
 D: 270 mm
 H: 70 mm
 1,9 kg

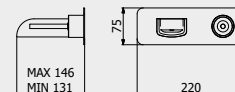

PORTATE | WATER FLOW | DÉBIT D'EAU

1 BAR	2 BAR	3 BAR
7,5 l/m	8 l/m	8 l/m

Built-in body to be purchased separately
 Corpo incasso da acquistare separatamente
 Corps intégré à acheter séparément



CODICE | CODE | CODE

INC206XXXN_19

COEFFICIENTE | COEFFICIENT | COEFFICIENT

2,9

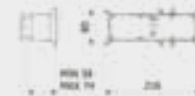

ARTICLE | ARTICOLO | ARTICLE

LM207



Wall mounted washbasin mixer with long spout complete with drain
 Miscelatore lavabo 2 fori a parete con bocca lunga completo di scarico automatico
 Mitigeur lavabo mural bec long complet avec bonde automatique

CODE / COEFFICIENT	CODICE / COEFFICIENTE	COEFFICIENT
CC	ELM207CC	13,7
SS	ELM207SS	17,1
ON	ELM207ON	13,7
BO	ELM207BO	16,4
NP	ELM207NP	16,4
CS	ELM207CS	20,6
IS	ELM207IS	21,9
SR	ELM207SR	21,9
OS	ELM207OS	21,9

PACKAGING

L: 275 mm
 D: 270 mm
 H: 70 mm
 1,9 kg

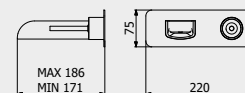

PORTATE | WATER FLOW | DÉBIT D'EAU

1 BAR	2 BAR	3 BAR
7,5 l/m	8 l/m	8 l/m

Built-in body to be purchased separately
 Corpo incasso da acquistare separatamente
 Corps intégré à acheter séparément



CODICE | CODE | CODE

INC206XXXN_19

COEFFICIENTE | COEFFICIENT | COEFFICIENT

2,9

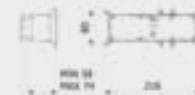

ARTICLE | ARTICOLO | ARTICLE

LM210



Ceiling spout with wall mounted mixer

Bocca da soffitto con comando remoto ad incasso

Mitigeur lavabo mural avec bec plafond complet avec bonde automatique

CODE / COEFFICIENT	CODICE / COEFFICIENTE	
CC	ELM210CC	27,5
SS	ELM210SS	34,4
BO	ELM210BO	33,0
NP	ELM210NP	33,0
ON	ELM210ON	27,5

PACKAGING

L: 150 mm
D: 190 mm
H: 98 mm

L: 1700 mm
Ø: 70 mm

4,5 kg

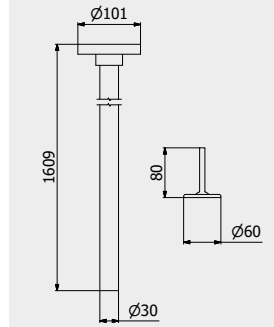

PORTATE | WATER FLOW | DÉBIT D'EAU

1 BAR	2 BAR	3 BAR
4,3 l/m	5,2 l/m	7 l/m

ARTICLE | ARTICOLO | ARTICLE

LM392



Three holes washbasin set with low spout

Lavabo tre fori a bocca bassa completo di scarico automatico

Lavabo trois trous bec bas

CODE / COEFFICIENT	CODICE / COEFFICIENTE	
CC	LM392CC	14,5
SS	LM392SS	18,1
BO	LM392BO	17,4
NP	LM392NP	17,4
ON	LM392ON	14,5

PACKAGING

L: 425 mm
D: 188 mm
H: 98 mm

3,9 kg

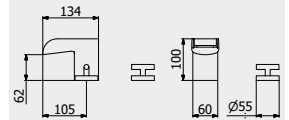

PORTATE | WATER FLOW | DÉBIT D'EAU

1 BAR	2 BAR	3 BAR
10 l/m	10,5 l/m	11 l/m

ARTICLE | ARTICOLO | ARTICLE

LM220



Monohole bidet mixer complete with drain

Miscelatore bidet monoforo completo di scarico automatico

Mitigeur bidet complet avec bonde automatique

CODE / COEFFICIENT	CODICE / COEFFICIENTE	
CC	LM220CC	9,8
SS	LM220SS	12,3
ON	LM220ON	9,8
BO	LM220BO	11,8
NP	LM220NP	11,8
CS	LM220CS	14,7
IS	LM220IS	15,7
SR	LM220SR	15,7
OS	LM220OS	15,7

PACKAGING

L: 240 mm
D: 215 mm
H: 110 mm

2,0 kg

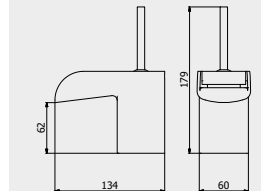

PORTATE | WATER FLOW | DÉBIT D'EAU

1 BAR	2 BAR	3 BAR
10 l/m	10,2 l/m	10,5 l/m



ARTICLE | ARTICOLO | ARTICLE

LM223



Mini monohole bidet mixer complete with drain
 Miscelatore bidet monoforo mini completo di scarico automatico
 Mitigeur bidet mini complet avec bonde automatique

CODE / COEFFICIENT	CODICE / COEFFICIENTE	
CC	LM223CC	7,9
SS	LM223SS	9,9
BO	LM223BO	9,5
NP	LM223NP	9,5

PACKAGING

L: 455 mm
 D: 310 mm
 H: 75 mm
 2,5 kg

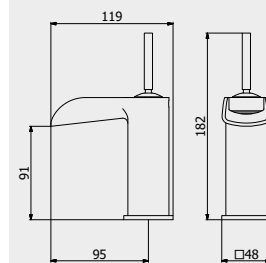

PORTATE | WATER FLOW | DÉBIT D'EAU

1 BAR	2 BAR	3 BAR
7 l/m	7 l/m	7,2 l/m

Loveme

ARTICLE | ARTICOLO | ARTICLE

LM393



Three holes bidet set
 Bidet tre fori con bocca snodabile completo di scarico automatico
 Bidet trois trous

CODE / COEFFICIENT	CODICE / COEFFICIENTE	
CC	LM393CC	14,5
SS	LM393SS	18,1
BO	LM393BO	17,4
NP	LM393NP	17,4
ON	LM393ON	14,5

PACKAGING

L: 425 mm
 D: 188 mm
 H: 98 mm
 3,9 kg

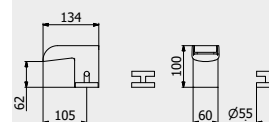

PORTATE | WATER FLOW | DÉBIT D'EAU

1 BAR	2 BAR	3 BAR
10 l/m	10,5 l/m	11 l/m

ARTICLE | ARTICOLO | ARTICLE

LM300



Exposed parts for manual wall mixer
 Set di parti esterne per miscelatore a parete ad una via
 Partie extérieure pour mitigeur encastré à une voie

CODE / COEFFICIENT	CODICE / COEFFICIENTE	
CC	ELM300CC	4,1
SS	ELM300SS	5,1
ON	ELM300ON	4,1
BO	ELM300BO	4,9
NP	ELM300NP	4,9
CS	ELM300CS	6,2
IS	ELM300IS	6,6
SR	ELM300SR	6,6
OS	ELM300OS	6,6

PACKAGING

L: 150 mm
 D: 190 mm
 H: 98 mm
 1,9 kg

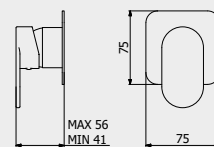

PORTATE | WATER FLOW | DÉBIT D'EAU

1 BAR	2 BAR	3 BAR
11,5 l/m	16,3 l/m	20 l/m

Built-in body to be purchased separately
 Corpo incasso da acquistare separatamente
 Corps intégré à acheter séparément



CODICE | CODE | CODE

INC300XXXN_19

COEFFICIENTE | COEFFICIENT | COEFFICIENT

1,8

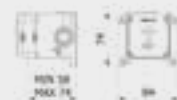

ARTICLE | ARTICOLO | ARTICLE

LM310



Exposed parts for manual wall mixer with two ways diverter
Miscelatore doccia a parete con deviatore due vie
Mitigeur douche mural deux voies avec inverseur

CODE / COEFFICIENT	CODICE / COEFFICIENTE	COEFFICIENT
CC	ELM310CC	6,1
SS	ELM310SS	7,6
ON	ELM310ON	6,1
BO	ELM310BO	7,3
NP	ELM310NP	7,3
CS	ELM310CS	9,2
IS	ELM310IS	9,8
SR	ELM310SR	9,8
OS	ELM310OS	9,8

PACKAGING

L: 150 mm
D: 190 mm
H: 98 mm

1,9 kg

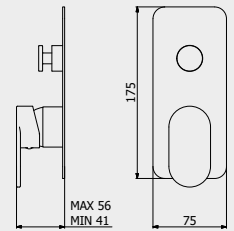

PORTATE | WATER FLOW | DÉBIT D'EAU

1 BAR	2 BAR	3 BAR
9,2 l/m	12,8 l/m	16 l/m

Built-in body to be purchased separately

Corpo incasso da acquistare separatamente

Corps intégré à acheter séparément



CODICE | CODE | CODE

INC310XXXN_19

COEFFICIENTE | COEFFICIENT | COEFFICIENT

3,3

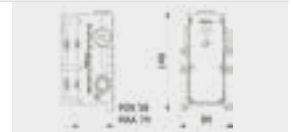

ARTICLE | ARTICOLO | ARTICLE

LM312



Exposed parts for manual wall mixer with three ways diverter
Set di parti esterne per miscelatore a parete a tre vie
Mitigeur douche mural trois voies avec inverseur

CODE / COEFFICIENT	CODICE / COEFFICIENTE	COEFFICIENT
CC	ELM312CC	7,4
SS	ELM312SS	9,3
ON	ELM312ON	7,4
BO	ELM312BO	8,9
NP	ELM312NP	8,9
CS	ELM312CS	11,1
IS	ELM312IS	11,8
SR	ELM312SR	11,8
OS	ELM312OS	11,8

PACKAGING

L: 150 mm
D: 190 mm
H: 98 mm

1,9 kg

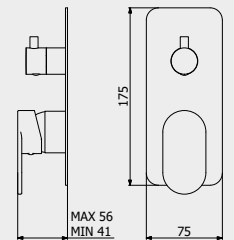

PORTATE | WATER FLOW | DÉBIT D'EAU

1 BAR	2 BAR	3 BAR
8,3 l/m	11,7 l/m	14,3 l/m

Built-in body to be purchased separately

Corpo incasso da acquistare separatamente

Corps intégré à acheter séparément



CODICE | CODE | CODE

INC312XXXN_19

COEFFICIENTE | COEFFICIENT | COEFFICIENT

3,3



ARTICLE | ARTICOLO | ARTICLE

LM313



Exposed parts for manual wall mixer with 2 ways with shower kit
Set di parti esterne per miscelatore a parete a due vie completo di kit doccia
Partie extérieure pour mitigeur encastré à deux voies avec douchette

CODE / COEFFICIENT	CODICE / COEFFICIENTE	COEFFICIENT
CC	ELM313CC	10,1
SS	ELM313SS	12,6
ON	ELM313ON	10,1
BO	ELM313BO	12,1
NP	ELM313NP	12,1
CS	ELM313CS	15,2
IS	ELM313IS	16,2
SR	ELM313SR	16,2
OS	ELM313OS	16,2

PACKAGING

L: 370 mm
D: 270 mm
H: 80 mm

2,2 kg

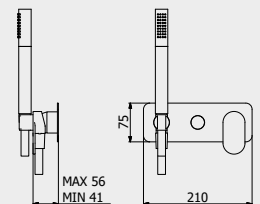

PORTATE | WATER FLOW | DÉBIT D'EAU

1 BAR	2 BAR	3 BAR
10 l/m	14,1 l/m	17,2 l/m

Built-in body to be purchased separately

Corpo incasso da acquistare separatamente

Corps intégré à acheter séparément



CODICE | CODE | CODE

INC313XXXN_19

COEFFICIENTE | COEFFICIENT | COEFFICIENT

3,6



ARTICLE | ARTICOLO | ARTICLE

LM314



Exposed parts for manual wall mixer with 3 ways with shower kit
Set di parti esterne per miscelatore a parete a tre vie completo di kit doccia
Partie extérieure pour mitigeur encastré à trois voies avec douchette

CODE / COEFFICIENT	CODICE / COEFFICIENTE	
CC	ELM314CC	11,4
SS	ELM314SS	14,3
ON	ELM314ON	11,4
BO	ELM314BO	13,7
NP	ELM314NP	13,7
CS	ELM314CS	17,1
IS	ELM314IS	18,2
SR	ELM314SR	18,2
OS	ELM314OS	18,2

PACKAGING

L: 370 mm
D: 270 mm
H: 80 mm
2,2 kg

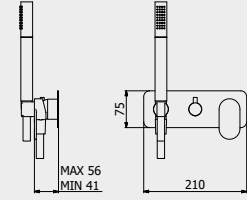

PORTATE | WATER FLOW | DÉBIT D'EAU

1 BAR	2 BAR	3 BAR
8,3 l/m	11,7 l/m	14,3 l/m

Loveme

Built-in body to be purchased separately

Corpo incasso da acquistare separatamente
Corps intégré à acheter séparément



CODICE | CODE | CODE

INC314XXXN_19

COEFFICIENTE | COEFFICIENT | COEFFICIENT

3,7



ARTICLE | ARTICOLO | ARTICLE

RU318



Built-in wall mounted waterfall spout
Cascata a parete con erogazione a lama esterna
Cascade murale avec bec externe

CODE / COEFFICIENT	CODICE / COEFFICIENTE	
CC	RU318CC	22,9
SS	RU318SS	28,6
BO	RU318BO	27,5
NP	RU318NP	27,5
CF	RU318CF	34,4
CS	RU318CS	36,6
II	RU318II	34,4
IS	RU318IS	36,6
RS	RU318RS	34,4
SR	RU318SR	36,6
OO	RU318OO	34,4
OS	RU318OS	36,6

PACKAGING

L: 340 mm
D: 180 mm
H: 70 mm
4,0 kg

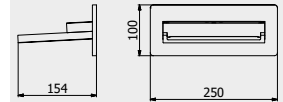

PORTATE | WATER FLOW | DÉBIT D'EAU

1 BAR	2 BAR	3 BAR
13 l/m	17,7 l/m	20 l/m

ARTICLE | ARTICOLO | ARTICLE

RU319



Wall mounted waterfall
Cascata a parete con erogazione diretta
Cascade murale

CODE / COEFFICIENT	CODICE / COEFFICIENTE	
CC	RU319CC	12,8
SS	RU319SS	16,0
BO	RU319BO	15,4
NP	RU319NP	15,4
CF	RU319CF	19,2
CS	RU319CS	20,5
II	RU319II	19,2
IS	RU319IS	20,5
RS	RU319RS	19,2
SR	RU319SR	20,5
OO	RU319OO	19,2
OS	RU319OS	20,5

PACKAGING

L: 340 mm
D: 180 mm
H: 70 mm
3,1 kg

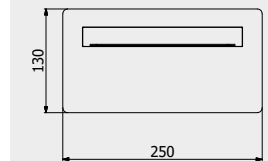

PORTATE | WATER FLOW | DÉBIT D'EAU

1 BAR	2 BAR	3 BAR
13 l/m	17,7 l/m	20 l/m

ARTICLE | ARTICOLO | ARTICLE

LM320



Wall mounted spout
Bocca d'erogazione a parete
Bec de remplissage mural

CODE / COEFFICIENT | CODICE /
COEFFICIENTE | CODE / COEFFICIENT

● CC	LM320CC	8,7
● SS	LM320SS	10,8
● BO	LM320BO	10,3
● NP	LM320NP	10,3
● ON	LM320ON	8,7

PACKAGING

	L: 175 mm
	D: 125 mm
	H: 90 mm
	1,8 kg

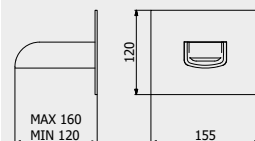

PORTATE | WATER FLOW | DÉBIT D'EAU

1 BAR	2 BAR	3 BAR
6,5 l/m	8 l/m	8 l/m

ARTICLE | ARTICOLO | ARTICLE

LM322



Long wall mounted spout
Bocca d'erogazione lunga a parete
Bec de remplissage mural long

CODE / COEFFICIENT | CODICE /
COEFFICIENTE | CODE / COEFFICIENT

● CC	LM322CC	9,3
● SS	LM322SS	11,7
● BO	LM322BO	11,2
● NP	LM322NP	11,2
● ON	LM322ON	9,3

PACKAGING

	L: 175 mm
	D: 125 mm
	H: 90 mm
	1,9 kg

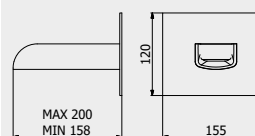

PORTATE | WATER FLOW | DÉBIT D'EAU

1 BAR	2 BAR	3 BAR
6,5 l/m	8 l/m	8 l/m

ARTICLE | ARTICOLO | ARTICLE

LM350



Wall mounted shower mixer with shower kit
Doccia esterno a parete completo di kit doccia
Mitigeur de douche externe avec flexible et douchette

CODE / COEFFICIENT | CODICE /
COEFFICIENTE | CODE / COEFFICIENT

● CC	LM350CC	17,3
● SS	LM350SS	20,4
● BO	LM350BO	19,7
● NP	LM350NP	19,7
● ON	LM350ON	17,3

PACKAGING

	L: 370 mm
	D: 220 mm
	H: 150 mm
	5,1 kg

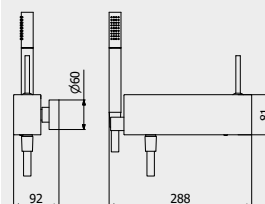

PORTATE | WATER FLOW | DÉBIT D'EAU

1 BAR	2 BAR	3 BAR
12,4 l/m	17,7 l/m	22,0 l/m

ARTICLE | ARTICOLO | ARTICLE

LM250



Wall mounted bath filler complete with hand shower kit
Bordo vasca esterno a parete completo di kit doccia
Mitigeur Bain/douche Mural avec douchette encastrée

CODE / COEFFICIENT | CODICE /
COEFFICIENTE | CODE / COEFFICIENT

● CC	LM250CC	22,3
● SS	LM250SS	27,9
● BO	LM250BO	26,8
● NP	LM250NP	26,8
● ON	LM250ON	22,3

PACKAGING

	L: 370 mm
	D: 220 mm
	H: 150 mm
	7,1 kg

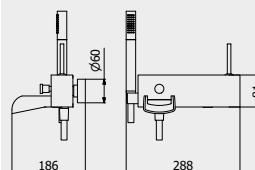

PORTATE | WATER FLOW | DÉBIT D'EAU

1 BAR	2 BAR	3 BAR
10,0 l/m	14,3 l/m	18,0 l/m



ARTICLE | ARTICOLO | ARTICLE

LM740



Two holes deck mounted bath filler mixer with shower kit
 Miscelatore bordo vasca da appoggio due fori con doccino
 Mitigeur bain deux trous avec douchette

CODE / COEFFICIENT	CODICE / COEFFICIENTE	
CC	LM740CC	25,0
SS	LM740SS	31,3
BO	LM740BO	30,0
NP	LM740NP	30,0

PACKAGING

L: 370 mm
 D: 220 mm
 H: 250 mm
 5,9 kg

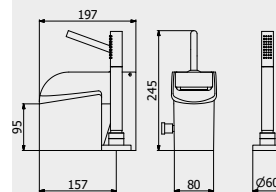

PORTATE | WATER FLOW | DÉBIT D'EAU

1 BAR	2 BAR	3 BAR
22,3 l/m	32 l/m	39,4 l/m

Loveme

ARTICLE | ARTICOLO | ARTICLE

LM750



Monohole deck mounted bath filler mixer
 Miscelatore bordo vasca da appoggio
 Mitigeur bain

CODE / COEFFICIENT	CODICE / COEFFICIENTE	
CC	LM750CC	23,4
SS	LM750SS	29,3
BO	LM750BO	28,1
NP	LM750NP	28,1

PACKAGING

L: 370 mm
 D: 220 mm
 H: 250 mm
 4,9 kg

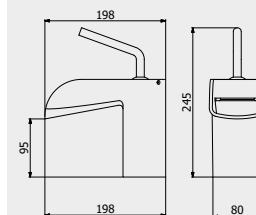

PORTATE | WATER FLOW | DÉBIT D'EAU

1 BAR	2 BAR	3 BAR
22,3 l/m	32 l/m	39,4 l/m

ARTICLE | ARTICOLO | ARTICLE

LM396



Four holes deck mounted bath filler with shower kit
 Bordo vasca quattro fori con deviatore e kit doccia
 Bain/douche quatre trous avec inverseur et Kit douche

CODE / COEFFICIENT	CODICE / COEFFICIENTE	
CC	LM396CC	21,5
SS	LM396SS	27,9
BO	LM396BO	25,8
NP	LM396NP	25,8
ON	LM396ON	21,5

PACKAGING

L: 425 mm
 D: 188 mm
 H: 98 mm
 5,7 kg

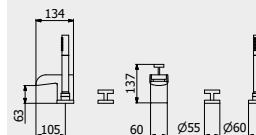

PORTATE | WATER FLOW | DÉBIT D'EAU

1 BAR	2 BAR	3 BAR
12,8 l/m	15,9 l/m	18,3 l/m

ARTICLE | ARTICOLO | ARTICLE

LM397



4 holes bath filler with overflow outlet connection, diverter and shower kit
Bordo vasca 4 fori per colonna riempimento con deviatore e kit doccia
Bain/douche 4 trous avec inverseur et Kit Douche pour remplissage ETP

CODE / COEFFICIENT	CODICE / COEFFICIENTE	
CC	LM397CC	14,2
SS	LM397SS	17,8
BO	LM397BO	17,0
NP	LM397NP	17,0
ON	LM397ON	14,2

PACKAGING

	L: 425 mm
	D: 188 mm
	H: 98 mm
	4,5 kg

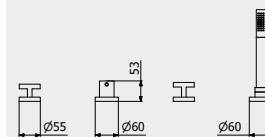

PORTATE | WATER FLOW | DÉBIT D'EAU

1 BAR	2 BAR	3 BAR
19 l/m	27 l/m	33 l/m

ARTICLE | ARTICOLO | ARTICLE

LM399



Free-standing bath filler with shower kit
Bordo vasca da terra con kit doccia
Bain douche complet alimentation au sol

CODE / COEFFICIENT	CODICE / COEFFICIENTE	
CC	ELM399CC	44,7
SS	ELM399SS	55,9
BO	ELM399BO	53,7
NP	ELM399NP	53,7
ON	ELM399ON	44,7

PACKAGING

	L: 1100 mm
	D: 400 mm
	H: 170 mm
	15,2 kg

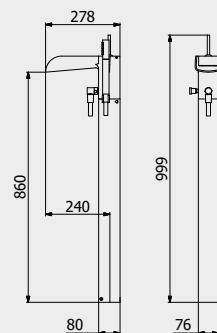

PORTATE | WATER FLOW | DÉBIT D'EAU

1 BAR	2 BAR	3 BAR
17 l/m	22 l/m	28 l/m

ARTICLE | ARTICOLO | ARTICLE

LM706



Exposed parts for bidet spray complete with mixer
Set di parti esterne per Idroscopino igienico con miscelatore
Partie extérieure pour douchette hygiénique avec mitigeur

CODE / COEFFICIENT	CODICE / COEFFICIENTE	
CC	ELM706CC	9,8
SS	ELM706SS	12,3
ON	ELM706ON	9,8
BO	ELM706BO	11,8
NP	ELM706NP	11,8
CS	ELM706CS	14,7
IS	ELM706IS	15,7
SR	ELM706SR	15,7
OS	ELM706OS	15,7

PACKAGING

	L: 370 mm
	D: 270 mm
	H: 80 mm
	3,2 kg

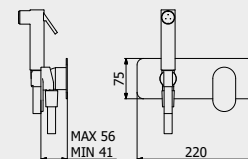

PORTATE | WATER FLOW | DÉBIT D'EAU

1 BAR	2 BAR	3 BAR
2,3 l/m	3,2 l/m	4 l/m

Built-in body to be purchased separately

Corpo incasso da acquistare separatamente

Corps intégré à acheter séparément



CODICE | CODE | CODE

INC206XXXN_19

COEFFICIENTE | COEFFICIENT | COEFFICIENT

2,9

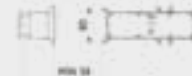

SNATCH / ACCESSORIES COLLECTION

Loveme

ARTICLE | ARTICOLO | ARTICLE

HJ001



Wall soap-holder
Porta sapone a muro
Porte distributeur de savon encastré

**CODICE / COEFFICIENTE | CODE /
COEFFICIENT | CODE / COEFFICIENT**

☐ CC	HJ001CC	5,5
☐ SS	HJ001SS	5,7
☐ BO	HJ001BO	5,7
● NP	HJ001NP	5,7
● CF	HJ001CF	5,7
● CS	HJ001CS	5,7
● II	HJ001II	5,7
● IS	HJ001IS	5,7
● RS	HJ001RS	5,7
● SR	HJ001SR	5,7
● OO	HJ001OO	5,7
● OS	HJ001OS	5,7

PACKAGING

☐	L: 150 mm	📦	0,4 kg
	D: 190 mm		
	H: 98 mm		

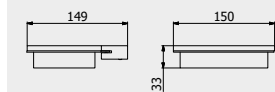

ARTICLE | ARTICOLO | ARTICLE

HJ003



Wall toothbrush holder
Porta spazzolino a muro
Porte brosse à dents encastré

**CODICE / COEFFICIENTE | CODE /
COEFFICIENT | CODE / COEFFICIENT**

☐ CC	HJ003CC	6,1
☐ SS	HJ003SS	6,3
☐ BO	HJ003BO	6,3
● NP	HJ003NP	6,3
● CF	HJ003CF	6,3
● CS	HJ003CS	6,3
● II	HJ003II	6,3
● IS	HJ003IS	6,3
● RS	HJ003RS	6,3
● SR	HJ003SR	6,3
● OO	HJ003OO	6,3
● OS	HJ003OS	6,3

PACKAGING

☐	L: 175 mm	📦	0,2 kg
	D: 125 mm		
	H: 90 mm		

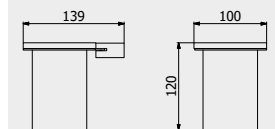

ARTICLE | ARTICOLO | ARTICLE

HJ016



Soap dispenser
Porta sapone da appoggio
Porte distributeur de savon

**CODICE / COEFFICIENTE | CODE /
COEFFICIENT | CODE / COEFFICIENT**

☐ CC	HJ016CC	2,2
☐ SS	HJ016SS	2,4
☐ BO	HJ016BO	2,4
● NP	HJ016NP	2,4
● CF	HJ016CF	2,4
● CS	HJ016CS	2,4
● II	HJ016II	2,4
● IS	HJ016IS	2,4
● RS	HJ016RS	2,4
● SR	HJ016SR	2,4
● OO	HJ016OO	2,4
● OS	HJ016OS	2,4

PACKAGING

☐	L: 150 mm	📦	1,1 kg
	D: 190 mm		
	H: 98 mm		

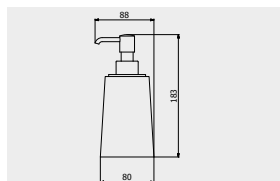

ARTICLE | ARTICOLO | ARTICLE

HJ017



Soap holder
Porta sapone da appoggio
Porte savon

**CODE / COEFFICIENT | CODE /
COEFFICIENT | CODE / COEFFICIENT**

☐ CC	HJ017CC	3,8
------	---------	-----

PACKAGING

☐	L: 175 mm	📦	0,5 kg
	D: 125 mm		
	H: 90 mm		

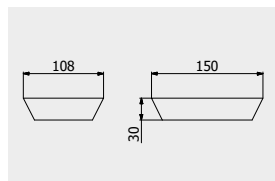

ARTICLE | ARTICOLO | ARTICLE

HJ010

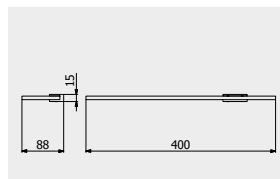

Shelf

Mensola

Etagère

CODICE / COEFFICIENTE | CODE /
COEFFICIENT | CODE / COEFFICIENT

CC	HJ010CC	5,1
SS	HJ010SS	5,3
BO	HJ010BO	5,3
NP	HJ010NP	5,3
CF	HJ010CF	5,3
CS	HJ010CS	5,3
II	HJ010II	5,3
IS	HJ010IS	5,3
RS	HJ010RS	5,3
SR	HJ010SR	5,3
OO	HJ010OO	5,3
OS	HJ010OS	5,3

PACKAGING

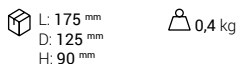

ARTICLE | ARTICOLO | ARTICLE

HJ011

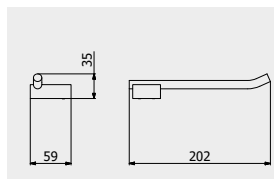

Toilet paper holder

Porta rotolo

Porte rouleaux de toilette

CODICE / COEFFICIENTE | CODE /
COEFFICIENT | CODE / COEFFICIENT

CC	HJ011CC	3,5
SS	HJ011SS	4,4
BO	HJ011BO	4,4
NP	HJ011NP	4,2
CF	HJ011CF	5,3
CS	HJ011CS	5,7
II	HJ011II	5,3
IS	HJ011IS	5,7
RS	HJ011RS	5,3
SR	HJ011SR	5,7
OO	HJ011OO	5,7
OS	HJ011OS	5,3

PACKAGING

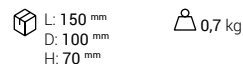

ARTICLE | ARTICOLO | ARTICLE

HJ009

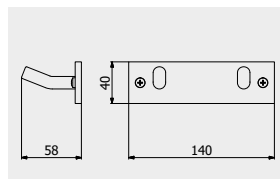

Double robe hook

Doppio appendino a parete

Double cintre

CODICE / COEFFICIENTE | CODE /
COEFFICIENT | CODE / COEFFICIENT

CC	HJ009CC	3,4
SS	HJ009SS	4,3
BO	HJ009BO	4,3
NP	HJ009NP	4,3
CF	HJ009CF	5,1
CS	HJ009CS	5,4
II	HJ009II	5,4
IS	HJ009IS	5,4
RS	HJ009RS	5,1
SR	HJ009SR	5,4
OO	HJ009OO	5,1
OS	HJ009OS	5,4

PACKAGING

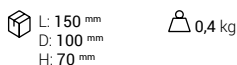

ARTICLE | ARTICOLO | ARTICLE

HJ004

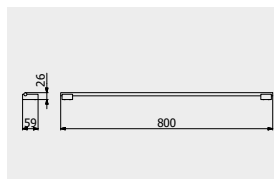

Towel holder

Porta salvietta

Porte-serviette

CODICE / COEFFICIENTE | CODE /
COEFFICIENT | CODE / COEFFICIENT

CC	HJ004CC	7,5
SS	HJ004SS	9,4
BO	HJ004BO	9,4
NP	HJ004NP	9,4
CF	HJ004CF	11,3
CS	HJ004CS	12,0
II	HJ004II	11,3
IS	HJ004IS	12,0
RS	HJ004RS	11,3
SR	HJ004SR	12,0
OO	HJ004OO	11,3
OS	HJ004OS	12,0

PACKAGING

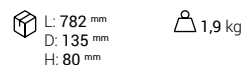

ARTICLE | ARTICOLO | ARTICLE

HJ014

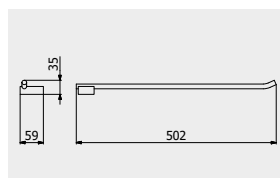

Towel holder

Porta salvietta

Porte-serviette

CODICE / COEFFICIENTE | CODE /
COEFFICIENT | CODE / COEFFICIENT

CC	HJ014CC	5,1
SS	HJ014SS	6,4
BO	HJ014BO	6,4
NP	HJ014NP	6,4
CF	HJ014CF	7,7
CS	HJ014CS	8,2
II	HJ014II	7,7
IS	HJ014IS	8,2
RS	HJ014RS	7,7
SR	HJ014SR	8,2
OO	HJ014OO	7,7
OS	HJ014OS	8,2

PACKAGING

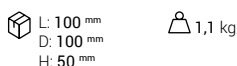

ARTICLE | ARTICOLO | ARTICLE

HJ006

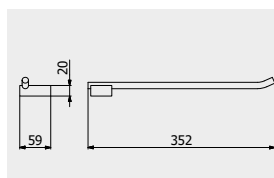

Towel holder

Porta salvietta

Porte-serviette

CODICE / COEFFICIENTE | CODE /
COEFFICIENT | CODE / COEFFICIENT

CC	HJ006CC	4,9
SS	HJ006SS	6,1
BO	HJ006BO	6,1
NP	HJ006NP	6,1
CF	HJ006CF	7,4
CS	HJ006CS	7,8
II	HJ006II	7,4
IS	HJ006IS	7,8
RS	HJ006RS	7,4
SR	HJ006SR	7,8
OO	HJ006OO	7,4
OS	HJ006OS	7,8

PACKAGING

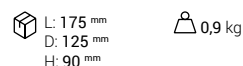

ARTICLE | ARTICOLO | ARTICLE

HJ007

Ring Towel holder

Porta salvietta ad anello

Porte-serviette anneau

CODICE / COEFFICIENTE | CODE / COEFFICIENT

CC	HJ007CC	5,0
SS	HJ007SS	6,3
BO	HJ007BO	6,3
NP	HJ007NP	6,3
CF	HJ007CF	7,5
CS	HJ007CS	8,0
II	HJ007II	7,5
IS	HJ007IS	8,0
RS	HJ007RS	7,5
SR	HJ007SR	8,0
OO	HJ007OO	7,5
OS	HJ007OS	8,0

PACKAGING

	L: 340 mm		1,9 kg
	D: 180 mm		
	H: 70 mm		

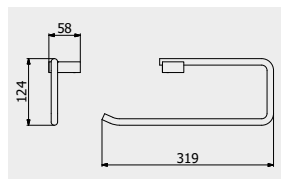

ARTICLE | ARTICOLO | ARTICLE

HJ012

Toilet brush holder

Porta scopino da terra

Porte balayette au sol

CODICE / COEFFICIENTE | CODE / COEFFICIENT

CC	HJ012CC	7,8
SS	HJ012SS	9,8
BO	HJ012BO	9,8
NP	HJ012NP	9,8
CF	HJ012CF	11,7
CS	HJ012CS	12,5
II	HJ012II	11,7
IS	HJ012IS	12,5
RS	HJ012RS	11,7
SR	HJ012SR	12,5
OO	HJ012OO	11,7
OS	HJ012OS	12,5

PACKAGING

	L: 100 mm		1,8 kg
	D: 100 mm		
	H: 50 mm		

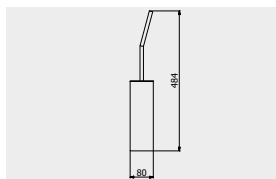

ARTICLE | ARTICOLO | ARTICLE

HJ015

Toothbrush holder

Porta spazzolino

Porte brosse à dents

CODICE / COEFFICIENTE | CODE / COEFFICIENT

CC	HJ015CC	2,8
----	---------	-----

PACKAGING

	L: 175 mm		0,6 kg
	D: 125 mm		
	H: 90 mm		

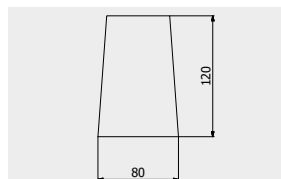

ARTICLE | ARTICOLO | ARTICLE

HJ018

Box

Scatola

Boîte

CODICE / COEFFICIENTE | CODE / COEFFICIENT

CC	HJ018CC	4,1
SS	HJ018SS	4,3
BO	HJ018BO	4,3
NP	HJ018NP	4,3
CF	HJ018CF	4,3
CS	HJ018CS	4,3
II	HJ018II	4,3
IS	HJ018IS	4,3
RS	HJ018RS	4,3
SR	HJ018SR	4,3
OO	HJ018OO	4,3
OS	HJ018OS	4,3

PACKAGING

	L: 240 mm		1,2 kg
	D: 215 mm		
	H: 110 mm		

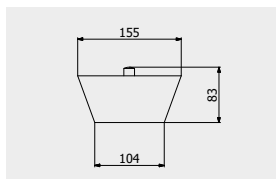

Loveme

BELMONDO / ELLE

The sparkling elegance of the roaring Twenties and Thirties.

L'eleganza sfavillante dei ruggenti anni Venti e Trenta.
L'élégance étincelante des années rugissantes 1920 et 1930.

A collection inspired by the sparkling style of the roaring Twenties and Thirties, with its octagonal shapes that recall the stick figure of a diamond, with geometric and particularly sophisticated lines. This emblematic and refined collection, suitable for any domestic environment, is made even more versatile by the double set of levers available. The free-jet spout guarantees an immediate and spontaneous water flow.

Una serie ispirata allo stile sfavillante dei ruggenti anni Venti e Trenta, con le sue forme ottagonali che richiamano la figura stilizzata di un diamante, linee geometriche eleganti e tratti particolarmente sofisticati. Questa linea emblematica e raffinata, adatta a qualsiasi ambiente casalingo, è resa ulteriormente versatile dalla disponibilità di una doppia leva. La bocca a getto libero garantisce un flusso d'acqua immediato e spontaneo.

Une collection inspirée par le style étincelant des années folles 1920 et 1930, avec ses formes octogonales qui rappellent la silhouette stylisée d'un diamant, avec ses lignes géométriques élégantes et ses traits particulièrement sophistiquées. Cette collection emblématique et raffinée, apte à tous les environnements domestiques, est rendue encore plus polyvalente par la disponibilité d'un double levier. Le bec au jet libre garantit un débit d'eau immédiat et spontané.



ANTI-LIMESCALE
AERATOR

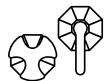

DOUBLE LEVER



LEAD FREE



ZINC FREE





The name refers to the “beautiful world” of the Twenties and the Thirties, to the luxurious houses of those times, with real bathrooms and multiple fragrances.

Il nome si riferisce al “bel mondo” degli anni Venti e Trenta, a quelle case lussuose dell'epoca con vere stanze da bagno e tanti profumi.

Le nom fait référence au «monde magnifique» des années 1920 et 1930, à ces maisons luxueuses de l'époque, avec des vraies salles de bains et des nombreux parfums.

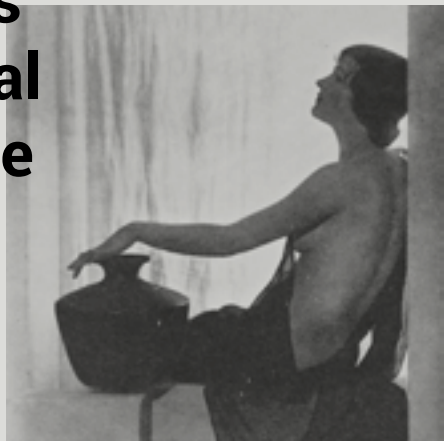

“ *Through this project I wanted to go deep inside the culture of the period between the two world wars, inspiring myself above all to Jean Puiforcat, French artist and designer who worked during those years. Even if it reminds to sophisticated cultural atmosphere from that age, these objects are still deeply original and they don't concern with imitation styling.*

Ho voluto fare un'immersione culturale nel raffinato design del periodo fra le due guerre, ispirandomi liberamente, soprattutto alla figura di Jean Puiforcat, artista e designer francese operante in quegli anni. Pur rimandando ad atmosfere di sofisticato lusso di certi ambienti culturali di quell'epoca, tuttavia questi oggetti restano sempre appartenenti ad un ambito di originalità progettuale che non sconfigna mai in styling d'imitazione.

“ *À travers ce projet, j'ai voulu aller au cœur de la culture de l'entre-deux-guerres, en m'inspirant avant tout de Jean Puiforcat, artiste et designer français de ces années. Même s'ils évoquent l'ambiance culturel sophistiqué de ces années, ces objets demeurent quand même profondément originaux, peu intéressés à un style d'imitation.*

”

Maurizio Duranti design for BELMONDO



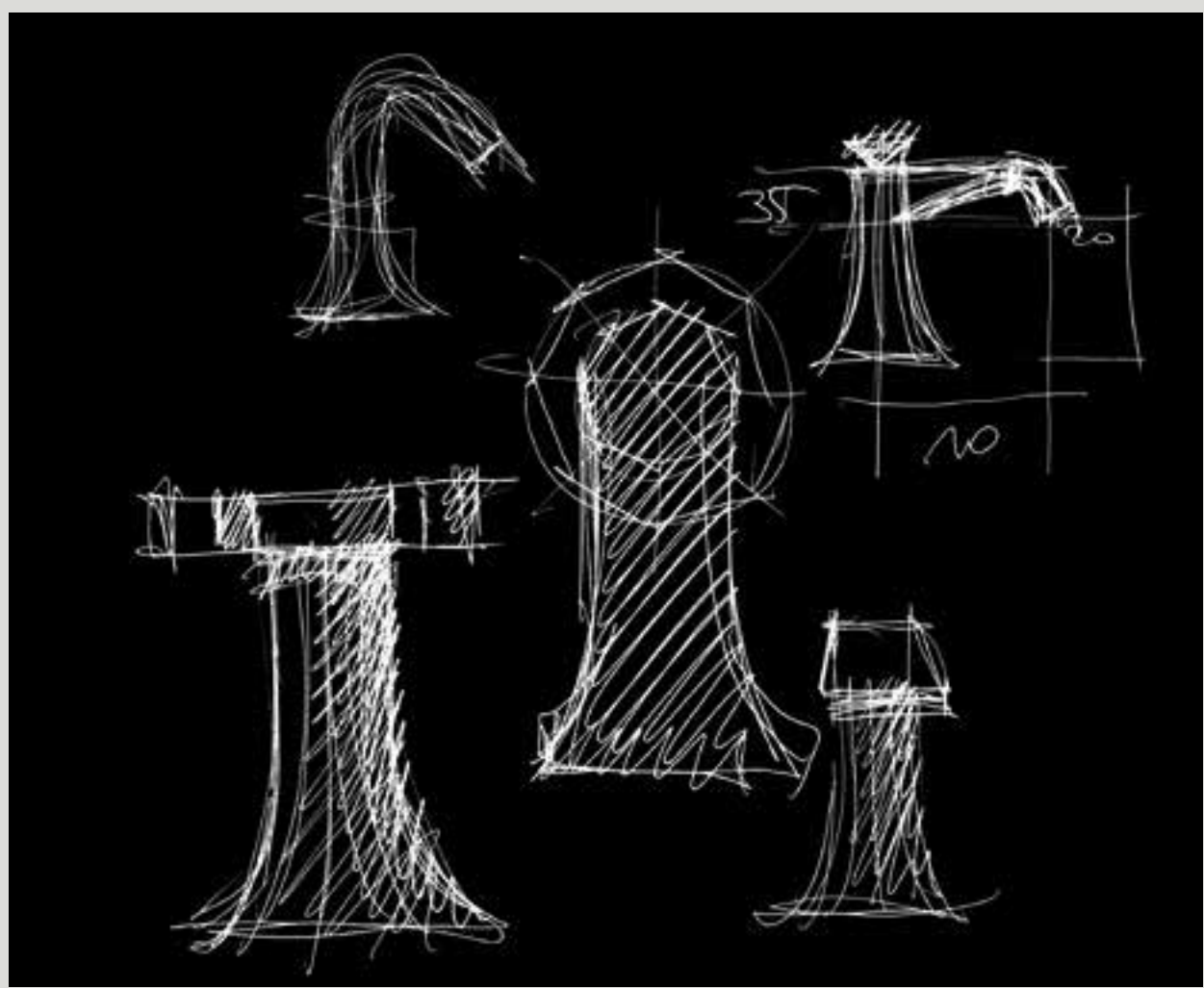



- ← BL200CC
Monohole washbasin mixer
Miscelatore lavabo monoforo
Mitigeur lavabo complet

- ↙ BT205CC
Monohole washbasin with two handles with drain
Lavabo monoforo con due leve
Mélangeur Lavabo Monotrou





Belmondo





← BL392RS
Three holes washbasin set with low spout
Lavabo tre fori bocca bassa
Lavabo trois trous bec bas

↑ BT392CC
Three holes washbasin set with low spout
Lavabo tre fori bocca bassa
Lavabo trois trous bec bas





Belmondo

- ← BT39300
Three holes bidet set
Bidet tre fori con bocca snodabile
Bidet trois trous

- ↑ BT306CC
Wall mounted washbasin mixer
Miscelatore lavabo due fori a parete
Mitigeur lavabo mural

- BL010
Shelf
Mensola
Etagère





- ← **BL300CC**
Exposed parts for manual wall mixer
Set di parti esterne per miscelatore a parete
ad una via
Partie extérieure pour mitigeur encastré à
une voie

- ↙ **BL001**
Wall soap-holder
Porta sapone a muro
Porte distributeur de savon encastré

- **BL314CC**
Exposed parts for manual wall mixer with
three ways diverter complete with shower kit
Set di parti esterne per miscelatore a parete a
tre vie completo di kit doccia
Partie extérieure pour mitigeur encastré à
trois voies avec douchette





Belmondo



↑ **BL350CC**

Wall mounted shower mixer with shower kit
Doccia esterno a parete di kit doccia
Mitigeur de douche externe avec flexible et
douchette

↗ **BL410CC**

Three holes wall mounted shower with two
ways diverter
Tre rubinetti a parete per doccia con deviatore
a due vie
Melangeur trois trous douche avec inverseur
deux voies





← BL250CC
 Wall mounted bath filler with hand shower kit
 Bordo vasca esterno a parete di kit doccia
 Mitigeur bain/douche mural avec douchette
 encastrée

↓ BL396CC
 Five holes deck mounted bath filler with
 shower kit
 Bordo vasca cinque fori con deviatore e kit doccia
 Bain/douche 5 trous avec inverseur et kit douche

A Hot water	D Diverter
Acqua calda	Deviatore
Eau chaude	Déviateur
B Spout	E Hand shower
Bocca d'erogazione	Doccino
Bec	Douchette
C Cold water	
Acqua fredda	
Eau froide	

→ BL700CC
 Free-standing two columns bath filler with
 shower kit
 Bordo vasca da terra a doppia colonna con
 kit doccia
 Mélangeur bain/douche complet avec
 alimentation sol





Belmondo



ARTICLE | ARTICOLO | ARTICLE

BL200



Monohole washbasin mixer complete with drain

Miscelatore lavabo monoforo completo di scarico automatico

Mélangeur lavabo complet avec bonde automatique

CODE / COEFFICIENT | CODICE /

COEFFICIENTE | CODE / COEFFICIENT

● CC	BL200CC	8,5
● PL	BL200PL	13,6
● II	BL200II	12,8
● RS	BL200RS	12,8
● OO	BL200OO	12,8

PACKAGING

L: 340 mm
D: 180 mm
H: 70 mm

1,9 kg

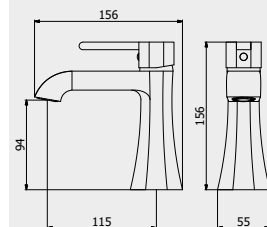

PORTATE | WATER FLOW | DÉBIT D'EAU

1 BAR	2 BAR	3 BAR
9,5 l/m	13l/m	19 l/m

ARTICLE | ARTICOLO | ARTICLE

BT205



Monohole washbasin with two handles complete with drain

Lavabo monoforo con due leve completo di scarico automatico

Mélangeur lavabo monotrou complet avec bonde automatique

CODE / COEFFICIENT | CODICE /

COEFFICIENTE | CODE / COEFFICIENT

● CC	BT205CC	9,6
● PL	BT205PL	15,4
● II	BT205II	14,4
● RS	BT205RS	14,4
● OO	BT205OO	14,4

PACKAGING

L: 360 mm
D: 220 mm
H: 150 mm

2,7 kg

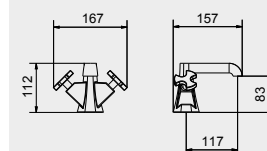

PORTATE | WATER FLOW | DÉBIT D'EAU

1 BAR	2 BAR	3 BAR
16,2 l/m	23,1 l/m	28,5 l/m

ARTICLE | ARTICOLO | ARTICLE

BL205



Monohole washbasin with two handles complete with drain

Lavabo monoforo con due leve completo di scarico automatico

Mélangeur lavabo monotrou complet avec bonde automatique

CODE / COEFFICIENT | CODICE /

COEFFICIENTE | CODE / COEFFICIENT

● CC	BL205CC	9,6
● PL	BL205PL	15,4
● II	BL205II	14,4
● RS	BL205RS	14,4
● OO	BL205OO	14,4

PACKAGING

L: 360 mm
D: 220 mm
H: 150 mm

2,8 kg

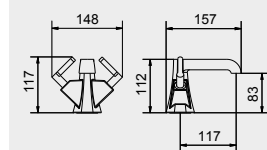

PORTATE | WATER FLOW | DÉBIT D'EAU

1 BAR	2 BAR	3 BAR
26,2 l/m	23,1 l/m	28,5 l/m

ARTICLE | ARTICOLO | ARTICLE

BT306



Wall mounted widespread lavatory faucet

Rubinetto lavabo da incasso

Robinet de lavabo mural

CODE / COEFFICIENT | CODICE /

COEFFICIENTE | CODE / COEFFICIENT

● CC	BT306CC	12,3
● PL	BT306PL	19,7
● II	BT306II	18,5
● RS	BT306RS	18,5
● OO	BT306OO	18,5

PACKAGING

L: 265 mm
D: 260 mm
H: 70 mm

1,7 kg

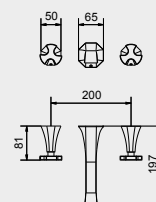

PORTATE | WATER FLOW | DÉBIT D'EAU

1 BAR	2 BAR	3 BAR
2,4 l/m	3,7 l/m	3,7 l/m



ARTICLE | ARTICOLO | ARTICLE

BL306



Wall mounted widespread lavatory faucet
 Rubinetto lavabo da incasso
 Robinet de lavabo mural

CODE / COEFFICIENT	CODICE / COEFFICIENTE	COEFFICIENT
● CC	BL306CC	12,3
● PL	BL306PL	19,7
● II	BL306II	18,5
● RS	BL306RS	18,5
● OO	BL306OO	18,5

PACKAGING

L: 265 mm
 D: 260 mm
 H: 70 mm
 1,7 kg

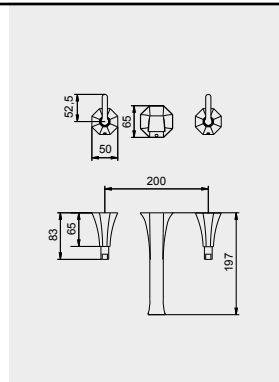

PORTATE | WATER FLOW | DÉBIT D'EAU

1 BAR	2 BAR	3 BAR
2,4 l/m	3,7 l/m	3,7 l/m

ARTICLE | ARTICOLO | ARTICLE

BT390



Three holes washbasin set with tall spout
 Lavabo tre fori bocca alta completo di scarico automatico
 Lavabo trois trous bec haut

CODE / COEFFICIENT	CODICE / COEFFICIENTE	COEFFICIENT
● CC	BT390CC	13,9
● PL	BT390PL	22,2
● II	BT390II	20,9
● RS	BT390RS	20,9
● OO	BT390OO	20,9

PACKAGING

L: 370 mm
 D: 270 mm
 H: 80 mm
 5,2 kg

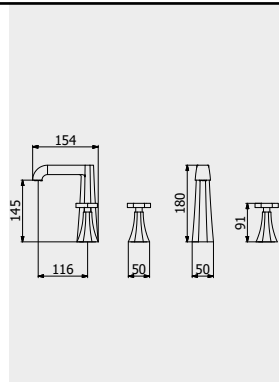

PORTATE | WATER FLOW | DÉBIT D'EAU

1 BAR	2 BAR	3 BAR
3,5 l/m	4 l/m	4 l/m

ARTICLE | ARTICOLO | ARTICLE

BL390



Three holes washbasin set with tall spout
 Lavabo tre fori bocca alta completo di scarico automatico
 Lavabo trois trous bec haut

CODE / COEFFICIENT	CODICE / COEFFICIENTE	COEFFICIENT
● CC	BL390CC	13,9
● PL	BL390PL	22,2
● II	BL390II	20,9
● RS	BL390RS	20,9
● OO	BL390OO	20,9

PACKAGING

L: 370 mm
 D: 270 mm
 H: 80 mm
 5,2 kg

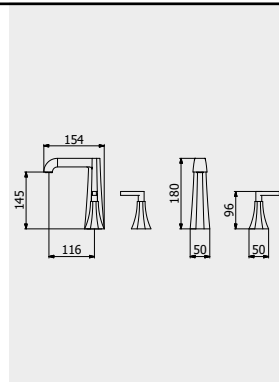

PORTATE | WATER FLOW | DÉBIT D'EAU

1 BAR	2 BAR	3 BAR
3,5 l/m	4 l/m	4 l/m

ARTICLE | ARTICOLO | ARTICLE

BT392



Three holes washbasin set with low spout
 Lavabo tre fori a bocca bassa completo di scarico automatico
 Lavabo trois trous bec bas

CODE / COEFFICIENT	CODICE / COEFFICIENTE	COEFFICIENT
● CC	BT392CC	12,3
● PL	BT392PL	19,7
● II	BT392II	18,5
● RS	BT392RS	18,5
● OO	BT392OO	18,5

PACKAGING

L: 370 mm
 D: 270 mm
 H: 80 mm
 4,3 kg

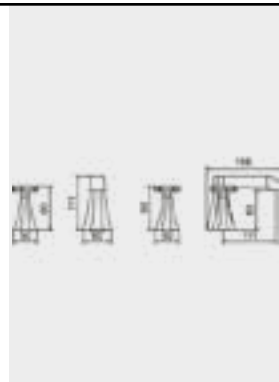

PORTATE | WATER FLOW | DÉBIT D'EAU

1 BAR	2 BAR	3 BAR
3,5 l/m	4 l/m	4 l/m

Belmondo

ARTICLE | ARTICOLO | ARTICLE

BL392



Three holes washbasin set with low spout

Lavabo tre fori a bocca bassa completo di scarico automatico

Lavabo trois trous bec bas

CODE / COEFFICIENT | CODICE /
COEFFICIENTE | CODE / COEFFICIENT

● CC	BL392CC	12,3
● PL	BL392PL	19,7
● II	BL392II	18,5
● RS	BL392RS	18,5
● OO	BL392OO	18,5

PACKAGING

 L: 370 mm
D: 270 mm
H: 80 mm

4,3 kg

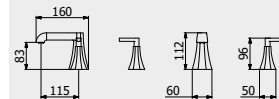

PORTATE | WATER FLOW | DÉBIT D'EAU

1 BAR	2 BAR	3 BAR
3,5 l/m	4 l/m	4 l/m

ARTICLE | ARTICOLO | ARTICLE

BL210

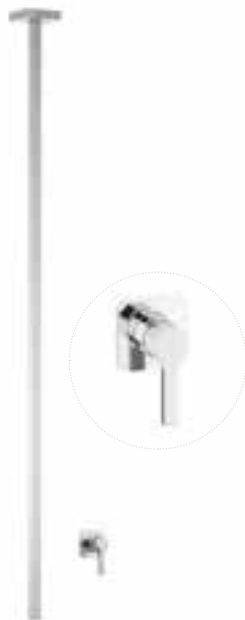

Ceiling spout with wall mounted mixer

Bocca da soffitto con comando remoto ad incasso

Mitigeur lavabo mural avec bec plafond complet avec bonde automatique

CODE / COEFFICIENT | CODICE /
COEFFICIENTE | CODE / COEFFICIENT

● CC	EBL210CC	33,8
● PL	EBL210PL	54,0
● II	EBL210II	50,6
● RS	EBL210RS	50,6
● OO	EBL210OO	50,6

PACKAGING

 L: 150 mm
D: 190 mm
H: 98 mm

 L: 1700 mm
Ø: 70 mm

4,5 kg

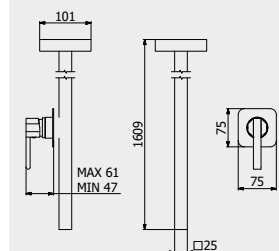

PORTATE | WATER FLOW | DÉBIT D'EAU

1 BAR	2 BAR	3 BAR
4,3 l/m	5,2 l/m	7 l/m

! Built-in body to be purchased separately

Corpo incasso da acquistare separatamente

Corps intégré à acheter séparément



CODICE | CODE | CODE

INC300XXXN_19

COEFFICIENTE | COEFFICIENT | COEFFICIENT

1,8



ARTICLE | ARTICOLO | ARTICLE

BL220



Monohole bidet mixer complete with drain

Miscelatore bidet monoforo completo di scarico automatico

Mitigeur bidet complet avec bonde automatique

CODE / COEFFICIENT | CODICE /
COEFFICIENTE | CODE / COEFFICIENT

● CC	BL220CC	8,5
● PL	BL220PL	13,6
● II	BL220II	12,8
● RS	BL220RS	12,8
● OO	BL220OO	12,8

PACKAGING

 L: 340 mm
D: 180 mm
H: 70 mm

1,8 kg

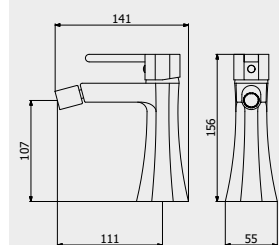

PORTATE | WATER FLOW | DÉBIT D'EAU

1 BAR	2 BAR	3 BAR
9,5 l/m	13 l/m	19 l/m



ARTICLE | ARTICOLO | ARTICLE

BT225



Monohole bidet with two handles complete with drain
 Bidet monoforo con due leve completo di scarico automatico
 Melangeur bidet monotrou complet avec bonde automatique

CODE / COEFFICIENT CODICE / COEFFICIENTE	COEFFICIENTE CODE / COEFFICIENT
● CC BT225CC	9,6
● PL BT225PL	15,4
● II BT225II	14,4
● RS BT225RS	14,4
● OO BT225OO	14,4

PACKAGING

L: 360 mm
 D: 220 mm
 H: 150 mm

 2,6 kg

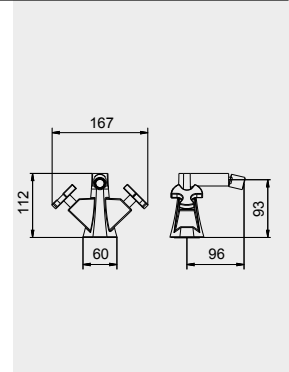

PORTATE | WATER FLOW | DÉBIT D'EAU

1 BAR	2 BAR	3 BAR
8 l/m	10,6 l/m	13,1 l/m

ARTICLE | ARTICOLO | ARTICLE

BL225



Monohole bidet with two handles complete with drain
 Bidet monoforo con due leve completo di scarico automatico
 Melangeur bidet monotrou complet avec bonde automatique

CODE / COEFFICIENT CODICE / COEFFICIENTE	COEFFICIENTE CODE / COEFFICIENT
● CC BL225CC	9,6
● PL BL225PL	15,4
● II BL225II	14,4
● RS BL225RS	14,4
● OO BL225OO	14,4

PACKAGING

L: 360 mm
 D: 220 mm
 H: 150 mm

 2,6 kg

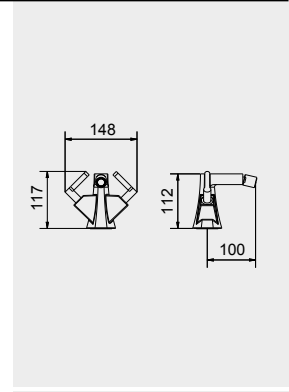

PORTATE | WATER FLOW | DÉBIT D'EAU

1 BAR	2 BAR	3 BAR
8 l/m	10,6 l/m	13,1 l/m

Belmondo

ARTICLE | ARTICOLO | ARTICLE

BT393



Three holes bidet set
 Bidet tre fori con bocca snodabile completo di scarico automatico
 Bidet trois trous

CODE / COEFFICIENT CODICE / COEFFICIENTE	COEFFICIENTE CODE / COEFFICIENT
● CC BT393CC	12,3
● PL BT393PL	19,7
● II BT393II	18,5
● RS BT393RS	18,5
● OO BT393OO	18,5

PACKAGING

L: 370 mm
 D: 270 mm
 H: 80 mm

 4,6 kg

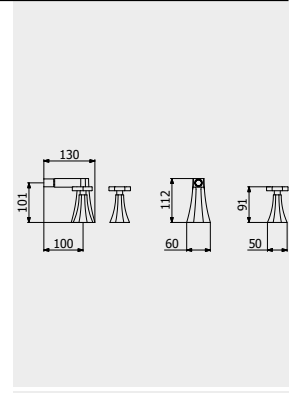

PORTATE | WATER FLOW | DÉBIT D'EAU

1 BAR	2 BAR	3 BAR
3,5 l/m	4 l/m	4 l/m

ARTICLE | ARTICOLO | ARTICLE

BL393



Three holes bidet set
 Bidet tre fori con bocca snodabile completo di scarico automatico
 Bidet trois trous

CODE / COEFFICIENT CODICE / COEFFICIENTE	COEFFICIENTE CODE / COEFFICIENT
● CC BL393CC	12,3
● PL BL393PL	19,7
● II BL393II	18,5
● RS BL393RS	18,5
● OO BL393OO	18,5

PACKAGING

L: 370 mm
 D: 270 mm
 H: 80 mm

 4,6 kg

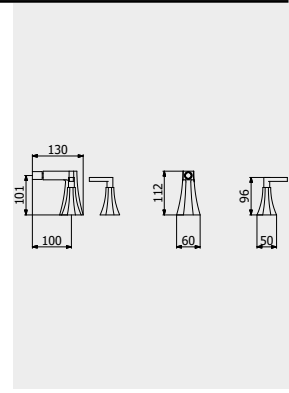

PORTATE | WATER FLOW | DÉBIT D'EAU

1 BAR	2 BAR	3 BAR
3,5 l/m	4 l/m	4 l/m

ARTICLE | ARTICOLO | ARTICLE

BL300



Exposed parts for manual wall mixer

Set di parti esterne per miscelatore a parete ad una via

Partie extérieure pour mitigeur encastré à une voie

CODE / COEFFICIENT | CODICE /
COEFFICIENTE | CODE / COEFFICIENT

● CC	EBL300CC	4,8
● PL	EBL300PL	7,7
● II	EBL300II	7,2
● RS	EBL300RS	7,2
● OO	EBL300OO	7,2

PACKAGING

 L: 150 mm
D: 190 mm
H: 98 mm

1,8 kg

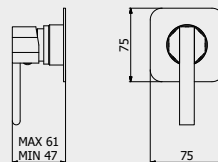

PORTATE | WATER FLOW | DÉBIT D'EAU

1 BAR	2 BAR	3 BAR
11,5 l/m	18,3 l/m	20 l/m

Built-in body to be purchased separately

Corpo incasso da acquistare separatamente

Corps intégré à acheter séparément



CODICE | CODE | CODE

INC300XXXN_19

COEFFICIENTE | COEFFICIENT | COEFFICIENT

1,8

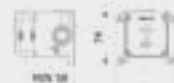

ARTICLE | ARTICOLO | ARTICLEV

BL310



Exposed parts for manual wall mixer with two ways diverter

Miscelatore doccia a parete con deviatore due vie

Mitigeur douche mural deux voies avec inverseur

CODE / COEFFICIENT | CODICE /
COEFFICIENTE | CODE / COEFFICIENT

● CC	EBL310CC	7,3
● PL	EBL310PL	11,7
● II	EBL310II	11,0
● RS	EBL310RS	11,0
● OO	EBL310OO	11,0

PACKAGING

 L: 150 mm
D: 190 mm
H: 98 mm

1,8 kg

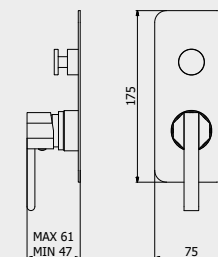

PORTATE | WATER FLOW | DÉBIT D'EAU

1 BAR	2 BAR	3 BAR
10,4 l/m	14,7 l/m	18 l/m

Built-in body to be purchased separately

Corpo incasso da acquistare separatamente

Corps intégré à acheter séparément



CODICE | CODE | CODE

INC310XXXN_19

COEFFICIENTE | COEFFICIENT | COEFFICIENT

3,3



ARTICLE | ARTICOLO | ARTICLE

BL312



Exposed parts for manual wall mixer with three ways diverter

Set di parti esterne per miscelatore a parete a tre vie

Mitigeur douche mural trois voies avec inverseur

CODE / COEFFICIENT | CODICE /
COEFFICIENTE | CODE / COEFFICIENT

● CC	EBL312CC	8,6
● PL	EBL312PL	13,8
● II	EBL312II	12,9
● RS	EBL312RS	12,9
● OO	EBL312OO	12,9

PACKAGING

 L: 150 mm
D: 190 mm
H: 98 mm

1,8 kg

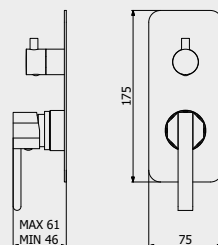

PORTATE | WATER FLOW | DÉBIT D'EAU

1 BAR	2 BAR	3 BAR
8,3 l/m	11,7 l/m	14,3 l/m

Built-in body to be purchased separately

Corpo incasso da acquistare separatamente

Corps intégré à acheter séparément



CODICE | CODE | CODE

INC312XXXN_19

COEFFICIENTE | COEFFICIENT | COEFFICIENT

3,3



ARTICLE | ARTICOLO | ARTICLE

BL313



Exposed parts for manual wall mixer with 2 ways with shower kit
Set di parti esterne per miscelatore a parete a due vie completo di kit doccia
Partie extérieure pour mitigeur encastré à deux voies avec douchette

CODE / COEFFICIENT	CODICE / COEFFICIENTE	COEFFICIENT
CC	EBL313CC	13,9
PL	EBL313PL	22,2
II	EBL313II	20,9
RS	EBL313RS	20,9
OO	EBL313OO	20,9

PACKAGING

L: 370 mm
D: 270 mm
H: 80 mm
2,1 kg

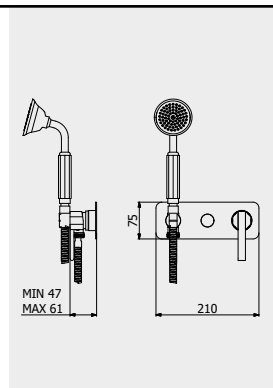

PORTATE | WATER FLOW | DÉBIT D'EAU

1 BAR	2 BAR	3 BAR
10 l/m	13,1 l/m	17,2 l/m

Built-in body to be purchased separately

Corpo incasso da acquistare separatamente
Corps intégré à acheter séparément



CODICE | CODE | CODE

INC313XXXN_19

COEFFICIENTE | COEFFICIENT | COEFFICIENT

3,6



Belmondo

ARTICLE | ARTICOLO | ARTICLE

BL314



Exposed parts for manual wall mixer with 3 ways with shower kit
Set di parti esterne per miscelatore a parete a tre vie completo di kit doccia
Partie extérieure pour mitigeur encastré à trois voies avec douchette

CODE / COEFFICIENT	CODICE / COEFFICIENTE	COEFFICIENT
CC	EBL314CC	15,8
PL	EBL314PL	25,3
II	EBL314II	23,7
RS	EBL314RS	23,7
OO	EBL314OO	23,7

PACKAGING

L: 370 mm
D: 270 mm
H: 80 mm
2,1 kg

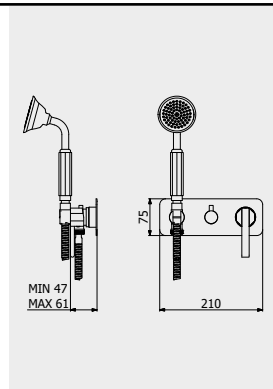

PORTATE | WATER FLOW | DÉBIT D'EAU

1 BAR	2 BAR	3 BAR
8,3 l/m	11,7 l/m	14,3 l/m

Built-in body to be purchased separately

Corpo incasso da acquistare separatamente
Corps intégré à acheter séparément



CODICE | CODE | CODE

INC314XXXN_19

COEFFICIENTE | COEFFICIENT | COEFFICIENT

3,7



ARTICLE | ARTICOLO | ARTICLE

BT400



Two holes wall mounted shower

Coppia di rubinetti a parete per doccia una via
Melangeur deux trous douche

CODE / COEFFICIENT	CODICE / COEFFICIENTE	COEFFICIENT
CC	BT400CC	6,5
PL	BT400PL	10,4
II	BT400II	9,8
RS	BT400RS	9,8
OO	BT400OO	9,8

PACKAGING

L: 175 mm
D: 125 mm
H: 90 mm
1,3 kg

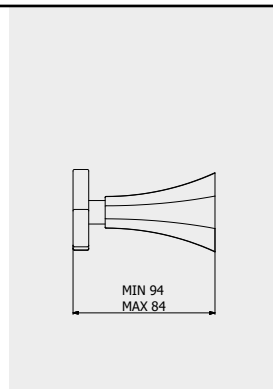

PORTATE | WATER FLOW | DÉBIT D'EAU

1 BAR	2 BAR	3 BAR
28 l/m	40 l/m	49,3 l/m

ARTICLE | ARTICOLO | ARTICLE

BL400



Two holes wall mounted shower

Coppia di rubinetti a parete per doccia una via

Melangeur deux trous douche

CODE / COEFFICIENT | CODICE /
COEFFICIENTE | CODE / COEFFICIENT

● CC	BL400CC	6,5
● PL	BL400PL	10,4
● II	BL400II	9,8
● RS	BL400RS	9,8
● OO	BL400OO	9,8

PACKAGING

 L: 175 mm
D: 125 mm
H: 90 mm

1,3 kg

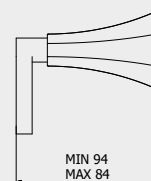

PORTATE | WATER FLOW | DÉBIT D'EAU

1 BAR	2 BAR	3 BAR
28 l/m	40 l/m	49,3 l/m

ARTICLE | ARTICOLO | ARTICLE

BT410



Three holes wall mounted shower with two ways diverter

Tre rubinetti a parete per doccia con deviatore a due vie

Melangeur trois trous douche avec inverseur deux voies

CODE / COEFFICIENT | CODICE /
COEFFICIENTE | CODE / COEFFICIENT

● CC	BT410CC	10,5
● PL	BT410PL	16,8
● II	BT410II	15,8
● RS	BT410RS	15,8
● OO	BT410OO	15,8

PACKAGING

 L: 340 mm
D: 180 mm
H: 70 mm

1,7 kg

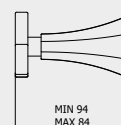

PORTATE | WATER FLOW | DÉBIT D'EAU

1 BAR	2 BAR	3 BAR
26 l/m	22,4 l/m	27,4 l/m

ARTICLE | ARTICOLO | ARTICLE

BL410



Three holes wall mounted shower with two ways diverter

Tre rubinetti a parete per doccia con deviatore a due vie

Melangeur 3 trous douche avec inverseur deux voies

CODE / COEFFICIENT | CODICE /
COEFFICIENTE | CODE / COEFFICIENT

● CC	BL410CC	10,5
● PL	BL410PL	16,8
● II	BL410II	15,8
● RS	BL410RS	15,8
● OO	BL410OO	15,8

PACKAGING

 L: 340 mm
D: 180 mm
H: 70 mm

1,7 kg

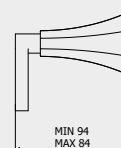

PORTATE | WATER FLOW | DÉBIT D'EAU

1 BAR	2 BAR	3 BAR
15 l/m	22 l/m	32 l/m

ARTICLE | ARTICOLO | ARTICLE

BT320



Wall mounted spout

Bocca d'erogazione a parete

Bec de remplissage mural

CODE / COEFFICIENT | CODICE /
COEFFICIENTE | CODE / COEFFICIENT

● CC	BT320CC	3,9
● PL	BT320PL	6,2
● II	BT320II	5,9
● RS	BT320RS	5,9
● OO	BT320OO	5,9

PACKAGING

 L: 210 mm
D: 130 mm
H: 70 mm

1,1 kg

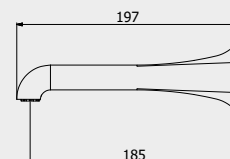

PORTATE | WATER FLOW | DÉBIT D'EAU

1 BAR	2 BAR	3 BAR
2,4 l/m	3,7 l/m	3,7 l/m



ARTICLE | ARTICOLO | ARTICLE

BT350



Wall mounted shower mixer with shower kit

Doccia esterno a parete completo di kit doccia

Mitigeur de douche externe avec flexible et douchette

CODE / COEFFICIENT	CODICE / COEFFICIENTE	
CC	BT350CC	14,4
PL	BT350PL	23,0
II	BT350II	21,6
RS	BT350RS	21,6
OO	BT350OO	21,6

PACKAGING

	L: 360 mm
	D: 220 mm
	H: 150 mm
	2,5 kg

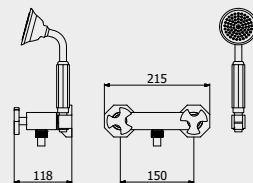

PORTATE | WATER FLOW | DÉBIT D'EAU

1 BAR	2 BAR	3 BAR
12,4 l/m	27,6 l/m	22 l/m

ARTICLE | ARTICOLO | ARTICLE

BL350



Wall mounted shower mixer with shower kit

Doccia esterno a parete completo di kit doccia

Mitigeur de douche externe avec flexible et douchette

CODE / COEFFICIENT	CODICE / COEFFICIENTE	
CC	BL350CC	14,4
PL	BL350PL	23,0
II	BL350II	21,6
RS	BL350RS	21,6
OO	BL350OO	21,6

PACKAGING

	L: 360 mm
	D: 220 mm
	H: 150 mm
	2,5 kg

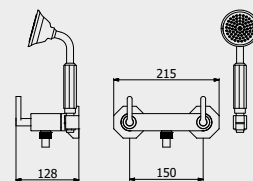

PORTATE | WATER FLOW | DÉBIT D'EAU

1 BAR	2 BAR	3 BAR
12,4 l/m	27,6 l/m	22 l/m

Belmondo

ARTICLE | ARTICOLO | ARTICLE

BT250



Wall mounted bath filler complete with hand shower kit

Bordo vasca esterno a parete completo di kit doccia

Mitigeur Bain/douche Mural avec douchette encastrée

CODE / COEFFICIENT	CODICE / COEFFICIENTE	
CC	BT250CC	23,4
PL	BT250PL	37,4
II	BT250II	35,1
RS	BT250RS	35,1
OO	BT250OO	35,1

PACKAGING

	L: 360 mm
	D: 220 mm
	H: 220 mm
	5,1 kg

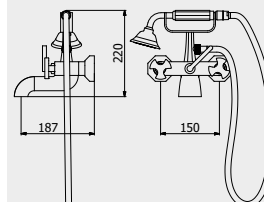

PORTATE | WATER FLOW | DÉBIT D'EAU

1 BAR	2 BAR	3 BAR
32,5 l/m	45,8 l/m	56 l/m

ARTICLE | ARTICOLO | ARTICLE

BL250



Wall mounted bath filler complete with hand shower kit

Bordo vasca esterno a parete completo di kit doccia

Mitigeur Bain/douche Mural avec douchette encastrée

CODE / COEFFICIENT	CODICE / COEFFICIENTE	
CC	BL250CC	23,4
PL	BL250PL	37,4
II	BL250II	35,1
RS	BL250RS	35,1
OO	BL250OO	35,1

PACKAGING

	L: 360 mm
	D: 220 mm
	H: 220 mm
	5,1 kg

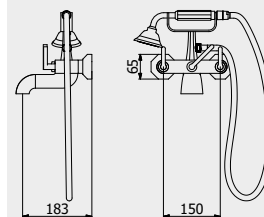

PORTATE | WATER FLOW | DÉBIT D'EAU

1 BAR	2 BAR	3 BAR
32,5 l/m	45,8 l/m	56 l/m

ARTICLE | ARTICOLO | ARTICLE

BT396



Five holes deck mounted bath filler with shower kit

Bordo vasca cinque fori con deviatore e kit doccia

Bain/douche cinq trous avec inverseur et Kit Douche

CODE / COEFFICIENT | CODICE /
COEFFICIENTE | CODE / COEFFICIENT

● CC	BT396CC	24,6
● PL	BT396PL	39,4
● II	BT396II	36,9
● RS	BT396RS	36,9
● OO	BT396OO	36,9

PACKAGING

L: 400 mm
D: 250 mm
H: 140 mm

4,4 kg

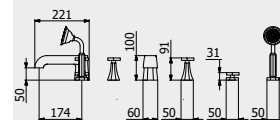

PORTATE | WATER FLOW | DÉBIT D'EAU

1 BAR	2 BAR	3 BAR
19 l/m	27 l/m	33 l/m

ARTICLE | ARTICOLO | ARTICLE

BL396



Five holes deck mounted bath filler with shower kit

Bordo vasca cinque fori con deviatore e kit doccia

Bain/douche cinq trous avec inverseur et Kit Douche

CODE / COEFFICIENT | CODICE /
COEFFICIENTE | CODE / COEFFICIENT

● CC	BL396CC	24,6
● PL	BL396PL	39,4
● II	BL396II	36,9
● RS	BL396RS	36,9
● OO	BL396OO	36,9

PACKAGING

L: 400 mm
D: 250 mm
H: 140 mm

4,4 kg

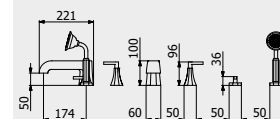

PORTATE | WATER FLOW | DÉBIT D'EAU

1 BAR	2 BAR	3 BAR
19 l/m	27 l/m	33 l/m

ARTICLE | ARTICOLO | ARTICLE

BT397



4 holes bath filler with overflow outlet connection, diverter and shower kit

Bordo vasca 4 fori per colonna riempimento con deviatore e kit doccia

Bain/douche 4 trous avec inverseur et Kit Douche pour remplissage ETP

CODE / COEFFICIENT | CODICE /
COEFFICIENTE | CODE / COEFFICIENT

● CC	BT397CC	18,1
● PL	BT397PL	29,0
● II	BT397II	27,2
● RS	BT397RS	27,2
● OO	BT397OO	27,2

PACKAGING

L: 400 mm
D: 250 mm
H: 140 mm

3,9 kg

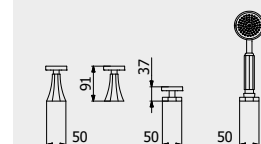

PORTATE | WATER FLOW | DÉBIT D'EAU

1 BAR	2 BAR	3 BAR
19 l/m	27 l/m	33 l/m

ARTICLE | ARTICOLO | ARTICLE

BL397



4 holes bath filler with overflow outlet connection, diverter and shower kit

Bordo vasca 4 fori per colonna riempimento con deviatore e kit doccia

Bain/douche 4 trous avec inverseur et Kit Douche pour remplissage ETP

CODE / COEFFICIENT | CODICE /
COEFFICIENTE | CODE / COEFFICIENT

● CC	BL397CC	18,1
● PL	BL397PL	29,0
● II	BL397II	27,2
● RS	BL397RS	27,2
● OO	BL397OO	27,2

PACKAGING

L: 400 mm
D: 250 mm
H: 140 mm

3,9 kg

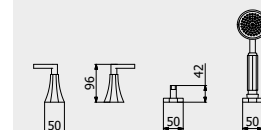

PORTATE | WATER FLOW | DÉBIT D'EAU

1 BAR	2 BAR	3 BAR
19 l/m	27 l/m	33 l/m



ARTICLE | ARTICOLO | ARTICLE

BT398



Five holes wall-mounted bath filler with shower kit
Bordo vasca a parete cinque fori con deviatore e kit doccia
Bain/douche cinq trous avec inverseur et Kit Douche

CODE / COEFFICIENT	CODICE / COEFFICIENTE	
CC	BT398CC	19,3
PL	BT398PL	30,9
II	BT398II	29,0
RS	BT398RS	29,0
OO	BT398OO	29,0

PACKAGING

L: 150 mm
D: 190 mm
H: 98 mm

2,6 kg

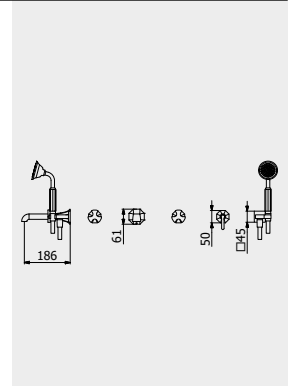

PORTATE | WATER FLOW | DÉBIT D'EAU

1 BAR	2 BAR	3 BAR
12,3 l/m	17,5 l/m	21,8 l/m

ARTICLE | ARTICOLO | ARTICLE

BL398



Five holes wall-mounted bath filler with shower kit
Bordo vasca a parete cinque fori con deviatore e kit doccia
Bain/douche cinq trous avec inverseur et Kit Douche

CODE / COEFFICIENT	CODICE / COEFFICIENTE	
CC	BL398CC	19,3
PL	BL398PL	30,9
II	BL398II	29,0
RS	BL398RS	29,0
OO	BL398OO	29,0

PACKAGING

L: 150 mm
D: 190 mm
H: 98 mm

2,6 kg

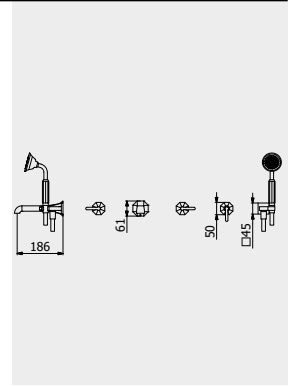

PORTATE | WATER FLOW | DÉBIT D'EAU

1 BAR	2 BAR	3 BAR
12,3 l/m	17,5 l/m	21,8 l/m

ARTICLE | ARTICOLO | ARTICLE

BT700



Free-standing two columns bath filler with shower kit
Bordo vasca da terra a doppia colonna con kit doccia
Mélangeur bain/douche complet avec alimentation sol

CODE / COEFFICIENT	CODICE / COEFFICIENTE	
CC	BT700CC	50,4
PL	BT700PL	80,6
II	BT700II	75,6
RS	BT700RS	75,6
OO	BT700OO	75,6

PACKAGING

L: 360 mm
D: 220 mm
H: 220 mm

10,5 kg

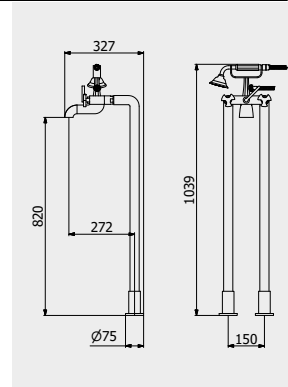

PORTATE | WATER FLOW | DÉBIT D'EAU

1 BAR	2 BAR	3 BAR
35 l/m	45,8 l/m	69,3 l/m

ARTICLE | ARTICOLO | ARTICLE

BL700



Free-standing two columns bath filler with shower kit
Bordo vasca da terra a doppia colonna con kit doccia
Mélangeur bain/douche complet avec alimentation sol

CODE / COEFFICIENT	CODICE / COEFFICIENTE	
CC	BL700CC	50,4
PL	BL700PL	80,6
II	BL700II	75,6
RS	BL700RS	75,6
OO	BL700OO	75,6

PACKAGING

L: 360 mm
D: 220 mm
H: 220 mm

10,5 kg

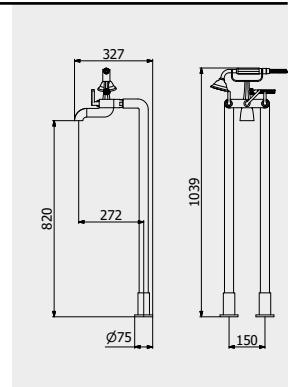

PORTATE | WATER FLOW | DÉBIT D'EAU

1 BAR	2 BAR	3 BAR
35 l/m	45,8 l/m	69,3 l/m

Belmondo

ARTICLE | ARTICOLO | ARTICLE

BL706



Exposed parts for bidet spray complete with mixer

Set di parti esterne per Idroscopino igienico con miscelatore

Partie extérieure pour douchette hygiénique avec mitigeur

CODE / COEFFICIENT | CODICE /
COEFFICIENTE | CODE / COEFFICIENT

● CC	EBL706CC	12,5
● PL	EBL706PL	20,0
● II	EBL706II	18,8
● RS	EBL706RS	18,8
● OO	EBL706OO	18,8

PACKAGING

L: 370 mm
D: 270 mm
H: 80 mm

3,1 kg

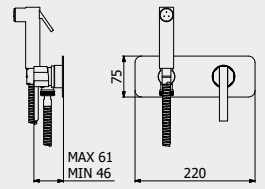

PORTATE | WATER FLOW | DÉBIT D'EAU

1 BAR	2 BAR	3 BAR
2,3 l/m	3,2 l/m	4 l/m

! Built-in body to be purchased separately

Corpo incasso da acquistare separatamente

Corps intégré à acheter séparément



CODICE | CODE | CODE

INC206XXXN_19

COEFFICIENTE | COEFFICIENT | COEFFICIENT

2,9

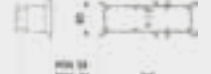

ARTICLE | ARTICOLO | ARTICLE

SH045

Duplex Belmondo

Duplex Belmondo

Duplex Belmondo

CODE / COEFFICIENT | CODICE /
COEFFICIENTE | CODE / COEFFICIENT

● CC	SH045CC	6,1
● OO	SH045OO	9,1
● II	SH045II	9,1
● RS	SH045RS	9,1
● PL	SH045PL	9,8

PACKAGING

L: 280 mm
D: 130 mm
H: 70 mm

1,7 kg

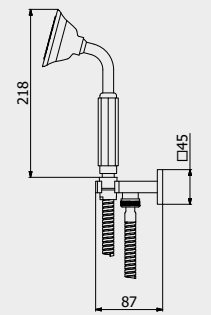

PORTATE | WATER FLOW | DÉBIT D'EAU

1 BAR	2 BAR	3 BAR
15,5 l/m	23,2 l/m	30 l/m

BELMONDO / ACCESSORIES COLLECTION

ARTICLE | ARTICOLO | ARTICLE

BL001

Wall soap-holder

Porta sapone a muro

Porte savon encastré

CODE / COEFFICIENT | CODICE /
COEFFICIENTE | CODE / COEFFICIENT

● CC	BL001CC	6,2
● PL	BL001PL	9,9
● II	BL001II	9,3
● RS	BL001RS	9,3
● OO	BL001OO	9,3

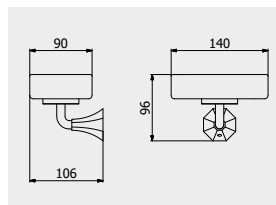

PACKAGING

L: 150 mm
D: 190 mm
H: 98 mm

0,6 kg

ARTICLE | ARTICOLO | ARTICLE

BL003

Wall toothbrush holder

Bicchiera porta spazzolino a parete

Porte-verre en verre gravé

CODE / COEFFICIENT | CODICE /
COEFFICIENTE | CODE / COEFFICIENT

● CC	BL003CC	5,3
● PL	BL003PL	8,5
● II	BL003II	8,0
● RS	BL003RS	8,0
● OO	BL003OO	8,0



PACKAGING

L: 180 mm
D: 180 mm
H: 100 mm

0,6 kg

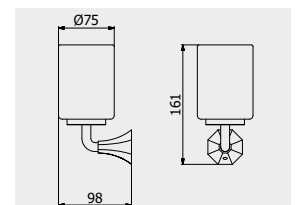

ARTICLE | ARTICOLO | ARTICLE

BL008



Robe Hook
Appendino a parete
Cintre

CODE / COEFFICIENT	CODICE / COEFFICIENTE	
CC	BL008CC	2,9
PL	BL008PL	4,6
II	BL008II	4,4
RS	BL008RS	4,4
OO	BL008OO	4,4

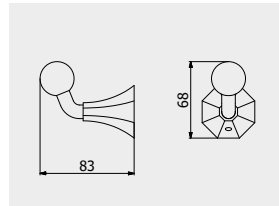

PACKAGING

L: 150 mm
D: 190 mm
H: 98 mm
0,3 kg

ARTICLE | ARTICOLO | ARTICLE

BL007



Ring Towel holder
Porta salvietta ad anello
Porte-serviette anneau

CODE / COEFFICIENT	CODICE / COEFFICIENTE	
CC	BL007CC	4,1
PL	BL007PL	6,6
II	BL007II	6,2
RS	BL007RS	6,2
OO	BL007OO	6,2

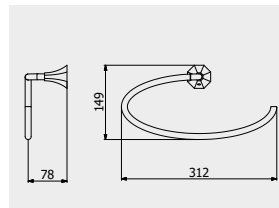

PACKAGING

L: 425 mm
D: 188 mm
H: 98 mm
1,0 kg

ARTICLE | ARTICOLO | ARTICLE

BL006



Towel holder
Porta salvietta
Porte-serviette

CODE / COEFFICIENT	CODICE / COEFFICIENTE	
CC	BL006CC	4,6
PL	BL006PL	7,4
II	BL006II	6,9
RS	BL006RS	6,9
OO	BL006OO	6,9

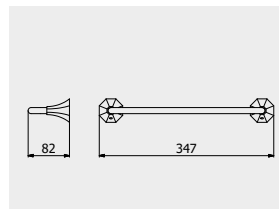

PACKAGING

L: 540 mm
D: 130 mm
H: 70 mm
0,9 kg

ARTICLE | ARTICOLO | ARTICLE

BL010



Shelf
Mensola
Etagère

CODE / COEFFICIENT	CODICE / COEFFICIENTE	
CC	BL010CC	3,9
PL	BL010PL	6,2
II	BL010II	5,9
RS	BL010RS	5,9
OO	BL010OO	5,9

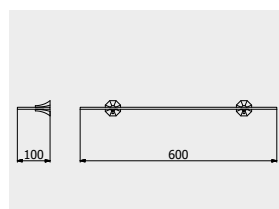

PACKAGING

L: 720 mm
D: 130 mm
H: 70 mm
1,3 kg

ARTICLE | ARTICOLO | ARTICLE

BL011



Toilet paper holder
Porta rotolo
Porte rouleaux de toilette

CODE / COEFFICIENT	CODICE / COEFFICIENTE	
CC	BL011CC	1,9
PL	BL011PL	3,0
II	BL011II	2,9
RS	BL011RS	2,9
OO	BL011OO	2,9

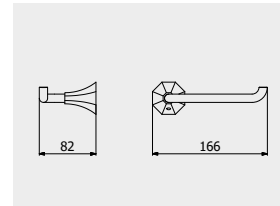

PACKAGING

L: 175 mm
D: 125 mm
H: 90 mm
0,4 kg

ARTICLE | ARTICOLO | ARTICLE

BL004



Towel holder
Porta salvietta
Porte-serviette

CODE / COEFFICIENT	CODICE / COEFFICIENTE	
CC	BL004CC	5,5
PL	BL004PL	8,8
II	BL004II	8,3
RS	BL004RS	8,3
OO	BL004OO	8,3

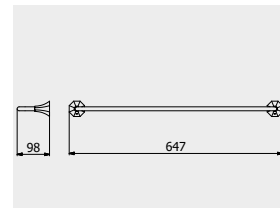

PACKAGING

L: 720 mm
D: 130 mm
H: 70 mm
1,2 kg

ARTICLE | ARTICOLO | ARTICLE

BL014



Towel holder
Porta salvietta
Porte-serviette

CODE / COEFFICIENT	CODICE / COEFFICIENTE	
CC	BL014CC	5,3
PL	BL014PL	8,5
II	BL014II	8,0
RS	BL014RS	8,0
OO	BL014OO	8,0

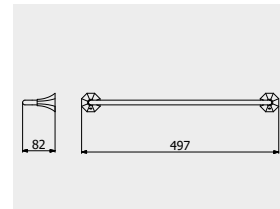

PACKAGING

L: 540 mm
D: 130 mm
H: 70 mm
1,0 kg

ARTICLE | ARTICOLO | ARTICLE

BL012



Toilet brush holder
Porta scopino da terra
Porte balayette au sol

CODE / COEFFICIENT	CODICE / COEFFICIENTE	
CC	BL012CC	5,2
PL	BL012PL	8,3
II	BL012II	7,8
RS	BL012RS	7,8
OO	BL012OO	7,8

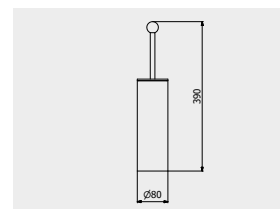

PACKAGING

L: 425 mm
D: 188 mm
H: 98 mm
1,0 kg

WAVE

Sinuuous and rounded shapes, providing pleasure and a touch of surprise.

Forme sinuose e arrotondate che regalano piacere e un tocco di sorpresa.
Formes sinueuses et arrondies qui donnent plaisir et une touche de surprise.

Sinuuous and rounded shapes, interspaced with more angular lines on the top, providing emotions, pleasure and a touch of surprise. The WAVE collection is a perfect balance between functionality and style, and testifies Marco Acerbis' approach to design. The sinuous body of the faucet is opposed to the resolute and pronounced lines of the lever just above, with a slightly inclined aerator to avoid splashing. The form becomes function and the function becomes form, in an unusual and exciting harmony.

Forme sinuose e arrotondate, intervallate da linee più squadrate nella parte superiore, che regalano emozione, piacere e un tocco di sorpresa. La serie WAVE è un perfetto equilibrio tra funzionalità e stile, e testimonia l'approccio di Marco Acerbis al design. Il flessuoso corpo del rubinetto lascia il posto poco più in alto ai tratti decisi e prominenti della leva e a un aeratore leggermente inclinato per evitare gli schizzi. La forma diventa funzione e la funzione si fa forma, in un bilanciamento inusuale e stimolante.

Formes sinueuses et arrondies, entrecoupées par des lignes plus carrées au sommet, qui donnent émotion, plaisir et une touche de surprise. La collection WAVE est un équilibre parfait entre fonctionnalité et style, et elle est témoin de l'approche de Marco Acerbis au design. Le corps sinueux du robinet laisse la place aux traits résolus et saillants du levier juste au-dessus, et à un aérateur légèrement incliné pour éviter les éclaboussures. La forme devient fonction et la fonction devient forme, dans un équilibre inédit et stimulant.



ANTI-LIMESCALE



CRYSTAL CLEAR
WATER



LEAD FREE



ZINC FREE





Wave

DESIGN
MARCO ACERBIS



“ The WAVE faucet, with its curvy and square shapes, fully attests my approach to design: the constant search for the perfect balance between the function, inherent in the object, and the aesthetic element, which must be able to excite and surprise.

Il rubinetto WAVE, con le sue forme a tratti sinuose e squadrate, testimonia appieno il mio approccio al design: la costante ricerca del perfetto equilibrio tra funzione, connaturata all'oggetto, e componente estetica, che deve saper emozionare e sorprendere.

Le robinet WAVE, aux formes sinueuses et carrées au même temps, témoigne pleinement mon approche au design: la recherche constante d'un équilibre parfait entre la fonction inhérente à l'objet et la composante esthétique, qui doit exciter et surprendre.

”





Wave

↑ WA200CC
Monohole washbasin mixer
Miscelatore lavabo monoforo
Mitigeur lavabo complet

← WA200CC
Monohole washbasin mixer
Miscelatore lavabo monoforo
Mitigeur lavabo complet

→ WA202CC
Tall monohole washbasin mixer
Miscelatore lavabo monoforo alto
Mitigeur lavabo haut







Wave

- ← WA206CC
Wall mounted washbasin mixer
Miscelatore lavabo due fori a parete
Mitigeur lavabo mural

- WA220CC
Monohole bidet mixer
Miscelatore bidet monoforo
Mitigeur bidet complet





- ← **WA314CC**
Three ways wall shower mixer complete with shower kit
Miscelatore doccia a parete con deviatore tre vie e doccia integrato
Mitigeur douche mural trois voies avec inverseur et douchette encastrée

- ↙ **WA350CC**
Wall mounted shower mixer with shower kit
Doccia esterno a parete completo di kit doccia
Mitigeur de douche externe avec flexible et douchette

- **WA313CC**
Two ways wall shower mixer complete with shower kit
Miscelatore doccia a parete con deviatore due vie e doccia integrato
Mitigeur douche mural deux voies avec inverseur et douchette encastrée









Wave

← **WA250CC**
Wall mounted bath filler with hand shower kit
Bordo vasca esterno a parete con kit doccia
Mitigeur bain/douche mural avec douchette
encastrée

↑ **WA320CC**
Wall mounted spout
Bocca d'erogazione a parete
Bec de remplissage mural

→ **WA318CC**
Built-in wall mounted waterfall spout
Cascata a parete con erogazione a lama esterna
Cascade murale avec bec externe





- ↖ WA399CC
- **Free-standing bath filler with shower kit**
Bordo vasca da terra con kit doccia
Bain douche complet alimentation au sol
- ← **WA740CC**
Two holes deck mounted bath filler mixer with shower kit
Miscelatore Bordo vasca da appoggio due fori con doccia
Mitigeur Bain/douche deux trous avec douchette



Wave

ARTICLE | ARTICOLO | ARTICLE

WA200



Monohole washbasin mixer complete with drain

Miscelatore lavabo monoforo completo di scarico automatico

Mitigeur lavabo complet avec bonde automatique

CODE / COEFFICIENT | CODICE /
COEFFICIENTE | CODE / COEFFICIENT

●	CC	WA200CC	6,5
●	SS	WA200SS	8,1
●	BO	WA200BO	7,8
●	NP	WA200NP	7,8
●	CF	WA200CF	9,8
●	CS	WA200CS	10,4
●	II	WA200II	9,8
●	IS	WA200IS	10,4
●	RS	WA200RS	9,8
●	SR	WA200SR	10,4
●	OO	WA200OO	9,8
●	OS	WA200OS	10,4

PACKAGING

 L: 340 mm
D: 180 mm
H: 70 mm

1,9 kg

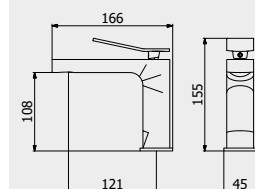

PORTATE | WATER FLOW | DÉBIT D'EAU

1 BAR	2 BAR	3 BAR
7 l/m	10 l/m	12,5 l/m

ARTICLE | ARTICOLO | ARTICLE

WA204



Mid-size monohole washbasin mixer complete with drain

Miscelatore lavabo monoforo medio completo di scarico automatico

Mitigeur lavabo moyen complet avec bonde automatique

CODE / COEFFICIENT | CODICE /
COEFFICIENTE | CODE / COEFFICIENT

●	CC	WA204CC	8,8
●	SS	WA204SS	11,0
●	BO	WA204BO	10,6
●	NP	WA204NP	10,6
●	CF	WA204CF	13,2
●	CS	WA204CS	14,1
●	II	WA204II	13,2
●	IS	WA204IS	14,1
●	RS	WA204RS	13,2
●	SR	WA204SR	14,1
●	OO	WA204OO	13,2
●	OS	WA204OS	14,1

PACKAGING

 L: 370 mm
D: 270 mm
H: 80 mm

2,2 kg

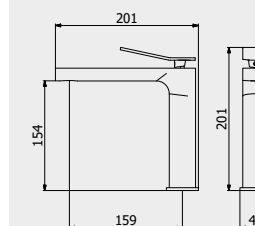

PORTATE | WATER FLOW | DÉBIT D'EAU

1 BAR	2 BAR	3 BAR
7 l/m	10 l/m	12,5 l/m

ARTICLE | ARTICOLO | ARTICLE

WA202



Tall monohole washbasin mixer complete with drain

Miscelatore lavabo monoforo alto completo di scarico automatico

Mitigeur lavabo haut complet avec bonde automatique

CODE / COEFFICIENT | CODICE /
COEFFICIENTE | CODE / COEFFICIENT

●	CC	WA202CC	9,5
●	SS	WA202SS	11,9
●	BO	WA202BO	11,4
●	NP	WA202NP	11,4
●	CF	WA202CF	14,3
●	CS	WA202CS	15,2
●	II	WA202II	14,3
●	IS	WA202IS	15,2
●	RS	WA202RS	14,3
●	SR	WA202SR	15,2
●	OO	WA202OO	14,3
●	OS	WA202OS	15,2

PACKAGING

 L: 370 mm
D: 270 mm
H: 80 mm

3,0 kg

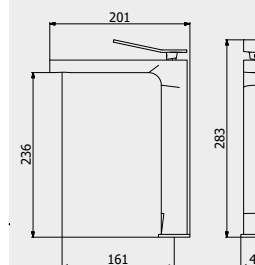

PORTATE | WATER FLOW | DÉBIT D'EAU

1 BAR	2 BAR	3 BAR
7 l/m	10 l/m	12,5 l/m



ARTICLE | ARTICOLO | ARTICLE

WA206



Wall mounted washbasin mixer complete with drain
 Miscelatore lavabo due fori a parete completo di scarico automatico
 Mitigeur lavabo mural complet avec bonde automatique

CODE / COEFFICIENT	CODICE / COEFFICIENTE	COEFFICIENT
CC	EWA206CC	8,8
SS	EWA206SS	11,0
BO	EWA206BO	10,6
NP	EWA206NP	10,6
CF	EWA206CF	13,2
CS	EWA206CS	14,1
II	EWA206II	13,2
IS	EWA206IS	14,1
RS	EWA206RS	13,2
SR	EWA206SR	14,1
OO	EWA206OO	13,2
OS	EWA206OS	14,1

PACKAGING

L: 265 mm
 D: 260 mm
 H: 70 mm
 1,7 kg

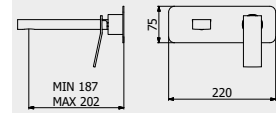

PORTATE | WATER FLOW | DÉBIT D'EAU

1 BAR	2 BAR	3 BAR
12,2 l/m	17,4 l/m	21,4 l/m

Built-in body to be purchased separately

Corpo incasso da acquistare separatamente

Corps intégré à acheter séparément



CODICE | CODE | CODE

INC206XXXN_19

COEFFICIENTE | COEFFICIENT | COEFFICIENT

2,9



Wave

ARTICLE | ARTICOLO | ARTICLE

WA210

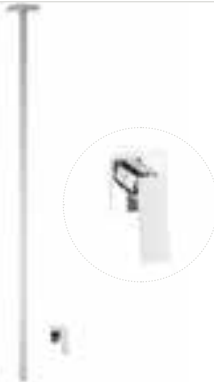

Ceiling spout with wall mounted mixer
 Bocca da soffitto con comando remoto ad incasso
 Mitigeur lavabo mural avec bec plafond complet avec bonde automatique

CODE / COEFFICIENT	CODICE / COEFFICIENTE	COEFFICIENT
CC	EWA210CC	33,8
SS	EWA210SS	42,3
BO	EWA210BO	40,6
NP	EWA210NP	40,6

PACKAGING

L: 150 mm
 D: 190 mm
 H: 98 mm
 L: 1700 mm
 Ø: 70 mm
 4,5 kg

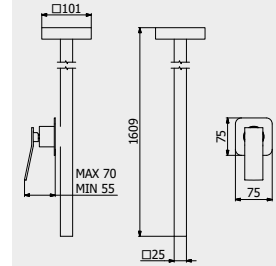

PORTATE | WATER FLOW | DÉBIT D'EAU

1 BAR	2 BAR	3 BAR
4,3 l/m	5,2 l/m	7 l/m

Built-in body to be purchased separately

Corpo incasso da acquistare separatamente

Corps intégré à acheter séparément



CODICE | CODE | CODE

INC300XXXN_19

COEFFICIENTE | COEFFICIENT | COEFFICIENT

1,8



ARTICLE | ARTICOLO | ARTICLE

WA299



Monohole free-standing washbasin mixer complete with drain
 Miscelatore lavabo da terra completo di scarico automatico
 Mitigeur lavabo free standing complet avec bonde automatique

CODE / COEFFICIENT	CODICE / COEFFICIENTE	COEFFICIENT
CC	EWA299CC	31,9
SS	EWA299SS	39,9
BO	EWA299BO	38,3
NP	EWA299NP	38,3
CF	EWA299CF	47,9
CS	EWA299CS	51,0
II	EWA299II	47,9
IS	EWA299IS	51,0
RS	EWA299RS	47,9
SR	EWA299SR	51,0
OO	EWA299OO	47,9
OS	EWA299OS	51,0

PACKAGING

L: 1160 mm
 D: 360 mm
 H: 180 mm
 14,5 kg

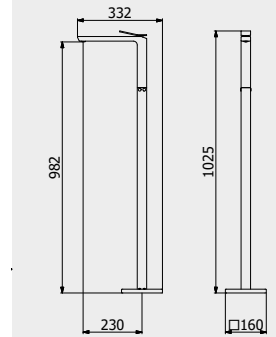

PORTATE | WATER FLOW | DÉBIT D'EAU

1 BAR	2 BAR	3 BAR
3,6 l/m	5,1 l/m	5,5 l/m

Built-in body to be purchased separately
 AVAILABLE FROM JANUARY 2020

Corpo incasso da acquistare separatamente
 DISPONIBILE DA GENNAIO 2020

Corps intégré à acheter séparément
 DISPONIBLE À PARTIR DE JANVIER 2020



CODICE | CODE | CODE

INC399XXXN_19

COEFFICIENTE | COEFFICIENT | COEFFICIENT

2,8

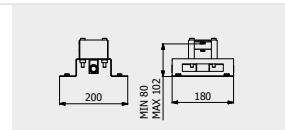

ARTICLE | ARTICOLO | ARTICLE

WA220



Monohole bidet mixer complete with drain

Miscelatore bidet monoforo completo di scarico automatico

Mitigeur bidet complet avec bonde automatique

CODE / COEFFICIENT | CODICE /
COEFFICIENTE | CODE / COEFFICIENT

CC	WA220CC	6,5
SS	WA220SS	8,1
BO	WA220BO	7,8
NP	WA220NP	7,8
CF	WA220CF	9,8
CS	WA220CS	10,4
II	WA220II	9,8
IS	WA220IS	10,4
RS	WA220RS	9,8
SR	WA220SR	10,4
OO	WA220OO	9,8
OS	WA220OS	10,4

PACKAGING

L: 340 mm
D: 180 mm
H: 70 mm

1,7 kg

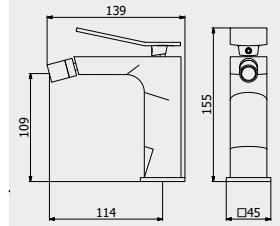

PORTATE | WATER FLOW | DÉBIT D'EAU

1 BAR	2 BAR	3 BAR
7 l/m	10 l/m	12,5 l/m

ARTICLE | ARTICOLO | ARTICLE

WA300



Exposed parts for manual wall mixer

Set di parti esterne per miscelatore a parete ad una via

Partie extérieure pour mitigeur encastré à une voie

CODE / COEFFICIENT | CODICE /
COEFFICIENTE | CODE / COEFFICIENT

CC	EWA300CC	4,1
SS	EWA300SS	5,1
BO	EWA300BO	4,9
NP	EWA300NP	4,9
CF	EWA300CF	6,2
CS	EWA300CS	6,6
II	EWA300II	6,2
IS	EWA300IS	6,6
RS	EWA300RS	6,2
SR	EWA300SR	6,6
OO	EWA300OO	6,2
OS	EWA300OS	6,6

PACKAGING

L: 150 mm
D: 190 mm
H: 98 mm

1,7 kg

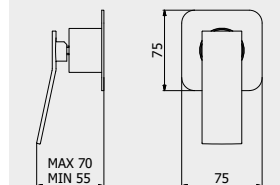

PORTATE | WATER FLOW | DÉBIT D'EAU

1 BAR	2 BAR	3 BAR
13,3 l/m	18,7 l/m	22,6 l/m

Built-in body to be purchased
separatelyCorpo incasso da acquistare
separatamenteCorps intégré à acheter
séparément

CODICE | CODE | CODE

INC300XXXN_19

COEFFICIENTE | COEFFICIENT | COEFFICIENT

1,8



ARTICLE | ARTICOLO | ARTICLE

WA310



Exposed parts for manual wall mixer with two ways diverter

Miscelatore doccia a parete con deviatore due vie

Mitigeur douche mural deux voies avec inverseur

CODE / COEFFICIENT | CODICE /
COEFFICIENTE | CODE / COEFFICIENT

CC	EWA310CC	6,1
SS	EWA310SS	7,6
BO	EWA310BO	7,3
NP	EWA310NP	7,3
CF	EWA310CF	9,2
CS	EWA310CS	9,8
II	EWA310II	9,2
IS	EWA310IS	9,8
RS	EWA310RS	9,2
SR	EWA310SR	9,8
OO	EWA310OO	9,2
OS	EWA310OS	9,8

PACKAGING

L: 150 mm
D: 190 mm
H: 98 mm

1,7 kg

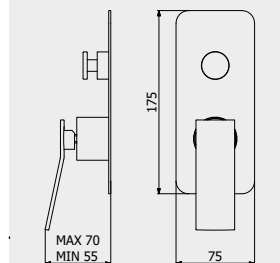

PORTATE | WATER FLOW | DÉBIT D'EAU

1 BAR	2 BAR	3 BAR
9,8 l/m	13,7 l/m	16,6 l/m

Built-in body to be purchased
separatelyCorpo incasso da acquistare
separatamenteCorps intégré à acheter
séparément

CODICE | CODE | CODE

INC310XXXN_19

COEFFICIENTE | COEFFICIENT | COEFFICIENT

3,3



ARTICLE | ARTICOLO | ARTICLE

WA312



Exposed parts for manual wall mixer with three ways diverter
Set di parti esterne per miscelatore a parete a tre vie
Mittigeur douche mural trois voies avec inverseur

CODE / COEFFICIENT	CODICE / COEFFICIENTE	COEFFICIENT
CC	EWA312CC	7,4
SS	EWA312SS	9,3
BO	EWA312BO	8,9
NP	EWA312NP	8,9
CF	EWA312CF	11,1
CS	EWA312CS	11,8
II	EWA312II	11,1
IS	EWA312IS	11,8
RS	EWA312RS	11,1
SR	EWA312SR	11,8
OO	EWA312OO	11,1
OS	EWA312OS	11,8

PACKAGING

L: 150 mm
D: 190 mm
H: 98 mm
1,7 kg

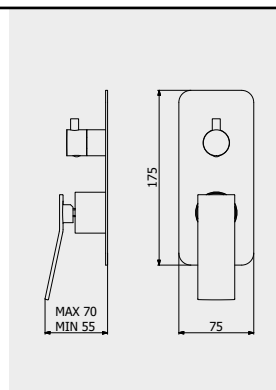

PORTATE	WATER FLOW	DÉBIT D'EAU
1 BAR	2 BAR	3 BAR
8,3 l/m	11,7 l/m	14,3 l/m

Built-in body to be purchased separately

Corpo incasso da acquistare separatamente
Corps intégré à acheter séparément



CODICE | CODE | CODE

INC312XXXN_19

COEFFICIENTE | COEFFICIENT | COEFFICIENT

3,3



Wave

ARTICLE | ARTICOLO | ARTICLE

WA313



Exposed parts for manual wall mixer with 2 ways with shower kit
Set di parti esterne per miscelatore a parete a due vie completo di kit doccia
Partie extérieure pour mitigeur encastré à deux voies avec douchette

CODE / COEFFICIENT	CODICE / COEFFICIENTE	COEFFICIENT
CC	EWA313CC	10,2
SS	EWA313SS	12,8
BO	EWA313BO	12,2
NP	EWA313NP	12,2
CF	EWA313CF	15,3
CS	EWA313CS	16,3
II	EWA313II	15,3
IS	EWA313IS	16,3
RS	EWA313RS	15,3
SR	EWA313SR	16,3
OO	EWA313OO	15,3
OS	EWA313OS	16,3

PACKAGING

L: 370 mm
D: 270 mm
H: 80 mm
2,1 kg

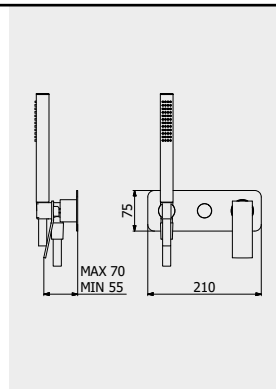

PORTATE	WATER FLOW	DÉBIT D'EAU
1 BAR	2 BAR	3 BAR
9,8 l/m	13,7 l/m	16,6 l/m

Built-in body to be purchased separately

Corpo incasso da acquistare separatamente
Corps intégré à acheter séparément



CODICE | CODE | CODE

INC313XXXN_19

COEFFICIENTE | COEFFICIENT | COEFFICIENT

3,6



ARTICLE | ARTICOLO | ARTICLE

WA314



Exposed parts for manual wall mixer with 3 ways with shower kit
Set di parti esterne per miscelatore a parete a tre vie completo di kit doccia
Partie extérieure pour mitigeur encastré à trois voies avec douchette

CODE / COEFFICIENT	CODICE / COEFFICIENTE	COEFFICIENT
CC	EWA314CC	11,6
SS	EWA314SS	14,5
BO	EWA314BO	13,9
NP	EWA314NP	13,9
CF	EWA314CF	17,4
CS	EWA314CS	18,6
II	EWA314II	17,4
IS	EWA314IS	18,6
RS	EWA314RS	17,4
SR	EWA314SR	18,6
OO	EWA314OO	17,4
OS	EWA314OS	18,6

PACKAGING

L: 370 mm
D: 270 mm
H: 80 mm
2,1 kg

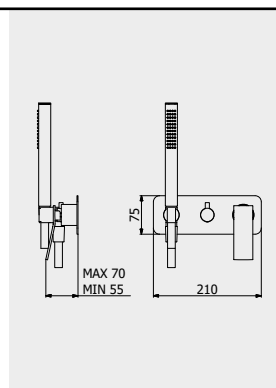

PORTATE	WATER FLOW	DÉBIT D'EAU
1 BAR	2 BAR	3 BAR
8,3 l/m	11,7 l/m	14,3 l/m

Built-in body to be purchased separately

Corpo incasso da acquistare separatamente
Corps intégré à acheter séparément



CODICE | CODE | CODE

INC314XXXN_19

COEFFICIENTE | COEFFICIENT | COEFFICIENT

3,7



ARTICLE | ARTICOLO | ARTICLE

RU318



Built-in wall mounted waterfall spout

Cascata a parete con erogazione a lama esterna

Cascade murale avec bec externe

CODE / COEFFICIENT | CODICE /
COEFFICIENTE | CODE / COEFFICIENT

● CC	RU318CC	22,9
● SS	RU318SS	28,6
● BO	RU318BO	27,5
● NP	RU318NP	27,5
● CF	RU318CF	34,4
● CS	RU318CS	36,6
● II	RU318II	34,4
● IS	RU318IS	36,6
● RS	RU318RS	34,4
● SR	RU318SR	36,6
● OO	RU318OO	34,4
● OS	RU318OS	36,6

PACKAGING

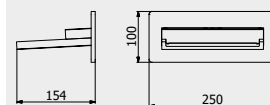
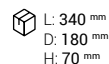

PORTATE | WATER FLOW | DÉBIT D'EAU

1 BAR	2 BAR	3 BAR
13 l/m	17 l/m	20 l/m

ARTICLE | ARTICOLO | ARTICLE

RU319



Wall mounted waterfall

Cascata a parete con erogazione diretta

Cascade murale

CODE / COEFFICIENT | CODICE /
COEFFICIENTE | CODE / COEFFICIENT

● CC	RU319CC	12,8
● SS	RU319SS	16,0
● BO	RU319BO	15,4
● NP	RU319NP	15,4
● CF	RU319CF	19,2
● CS	RU319CS	20,5
● II	RU319II	19,2
● IS	RU319IS	20,5
● RS	RU319RS	19,2
● SR	RU319SR	20,5
● OO	RU319OO	19,2
● OS	RU319OS	20,5

PACKAGING

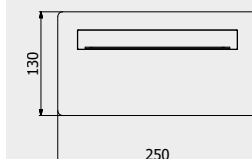
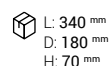

PORTATE | WATER FLOW | DÉBIT D'EAU

1 BAR	2 BAR	3 BAR
13 l/m	17 l/m	20 l/m

ARTICLE | ARTICOLO | ARTICLE

WA250



Wall mounted bath filler complete with hand shower kit

Bordo vasca esterno a parete completo di kit doccia

Mitigeur Bain/douche Murale avec douchette encastrée

CODE / COEFFICIENT | CODICE /
COEFFICIENTE | CODE / COEFFICIENT

● CC	WA250CC	18,4
● SS	WA250SS	23,0
● BO	WA250BO	22,1
● NP	WA250NP	22,1
● CF	WA250CF	27,6
● CS	WA250CS	29,4
● II	WA250II	27,6
● IS	WA250IS	29,4
● RS	WA250RS	27,6
● SR	WA250SR	29,4
● OO	WA250OO	27,6
● OS	WA250OS	29,4

PACKAGING

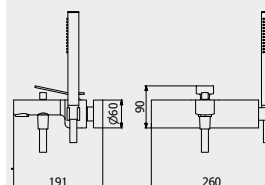
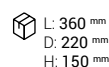

PORTATE | WATER FLOW | DÉBIT D'EAU

1 BAR	2 BAR	3 BAR
10,8 l/m	15,3 l/m	19 l/m

ARTICLE | ARTICOLO | ARTICLE

WA740



Two holes deck mounted bath filler mixer with shower kit

Miscelatore bordo vasca da appoggio due fori con doccino

Mitigeur bain/douche deux trous avec douchette

CODE / COEFFICIENT | CODICE /
COEFFICIENTE | CODE / COEFFICIENT

● CC	WA740CC	21,6
● SS	WA740SS	27,0
● BO	WA740BO	25,9
● NP	WA740NP	25,9
● CF	WA740CF	32,4
● CS	WA740CS	34,6
● II	WA740II	32,4
● IS	WA740IS	34,6
● RS	WA740RS	32,4
● SR	WA740SR	34,6
● OO	WA740OO	32,4
● OS	WA740OS	34,6

PACKAGING

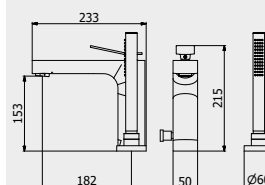
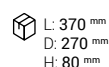

PORTATE | WATER FLOW | DÉBIT D'EAU

1 BAR	2 BAR	3 BAR
13,7 l/m	19,7 l/m	24,3 l/m



ARTICLE | ARTICOLO | ARTICLE

WA399



Free-standing bath filler with shower kit
Bordo vasca da terra con kit doccia
Bain douche complet alimentation au sol

CODE / COEFFICIENT CODICE / COEFFICIENTE CODE / COEFFICIENT	
CC EWA399CC	34,7
SS EWA399SS	43,4
BO EWA399BO	41,6
NP EWA399NP	41,6
CF EWA399CF	52,1
CS EWA399CS	55,5
II EWA399II	52,1
IS EWA399IS	55,5
RS EWA399RS	52,1
SR EWA399SR	55,5
OO EWA399OO	52,1
OS EWA399OS	55,5

PACKAGING

L: 1110 mm
D: 400 mm
H: 170 mm
11,6 kg

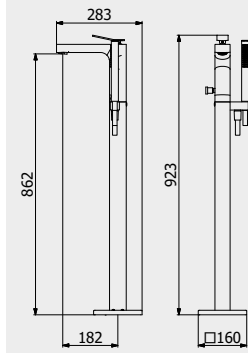

PORTATE | WATER FLOW | DÉBIT D'EAU

1 BAR	2 BAR	3 BAR
13,6 l/m	19,6 l/m	24,1 l/m

Built-in body to be purchased separately
AVAILABLE FROM JANUARY 2020
Corpo incasso da acquistare separatamente
DISPONIBILE DA GENNAIO 2020
Corps intégré à acheter séparément
DISPONIBLE À PARTIR DE JANVIER 2020



CODICE | CODE | CODE

INC399XXXN_19

COEFFICIENTE | COEFFICIENT | COEFFICIENT

2,8

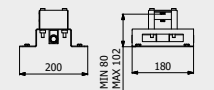

Wave

ARTICLE | ARTICOLO | ARTICLE

WA320



Wall mounted spout
Bocca d'erogazione a parete
Bec de remplissage mural

CODE / COEFFICIENT CODICE / COEFFICIENTE CODE / COEFFICIENT	
CC WA320CC	4,7
SS WA320SS	5,9
BO WA320BO	5,6
NP WA320NP	5,6
CF WA320CF	7,1
CS WA320CS	7,5
II WA320II	7,1
IS WA320IS	7,5
RS WA320RS	7,1
SR WA320SR	7,5
OO WA320OO	7,1
OS WA320OS	7,5

PACKAGING

L: 455 mm
D: 107 mm
H: 41 mm
1,0 kg

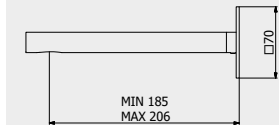

PORTATE | WATER FLOW | DÉBIT D'EAU

1 BAR	2 BAR	3 BAR
16 l/m	22 l/m	27 l/m

ARTICLE | ARTICOLO | ARTICLE

WA706



Exposed parts for bidet spray complete with mixer
Set di parti esterne per Idroscopino igienico con miscelatore
Partie extérieure pour douchette hygiénique avec mitigeur

CODE / COEFFICIENT CODICE / COEFFICIENTE CODE / COEFFICIENT	
CC EWA706CC	11,0
SS EWA706SS	13,8
BO EWA706BO	13,2
NP EWA706NP	13,2
CF EWA706CF	16,5
CS EWA706CS	17,6
II EWA706II	16,5
IS EWA706IS	17,6
RS EWA706RS	16,5
SR EWA706SR	17,6
OO EWA706OO	16,5
OS EWA706OS	17,6

PACKAGING

L: 370 mm
D: 270 mm
H: 80 mm
3,1 kg

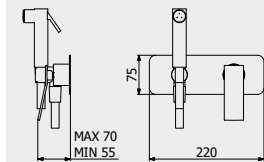

PORTATE | WATER FLOW | DÉBIT D'EAU

1 BAR	2 BAR	3 BAR
2,3 l/m	3,2 l/m	4 l/m

Built-in body to be purchased separately
! Corpo incasso da acquistare separatamente
Corps intégré à acheter séparément



CODICE | CODE | CODE

INC206XXXN_19

COEFFICIENTE | COEFFICIENT | COEFFICIENT

2,9

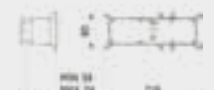

MODERNA / ACCESSORIES COLLECTION

ARTICLE | ARTICOLO | ARTICLE

MO001

Wall soap-holder

Porta sapone a muro

Porte distributeur de savon encastré

CODE / COEFFICIENT | CODICE /
COEFFICIENTE | CODE / COEFFICIENT

CC MO001CC 1,5

PACKAGING

L: 110 mm
 D: 130 mm
 H: 50 mm
 0,4 kg

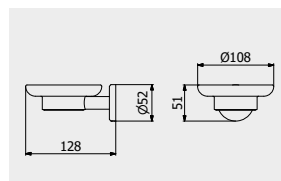

ARTICLE | ARTICOLO | ARTICLE

MO002

Wall soap dispenser holder

Porta dispenser sapone liquido a parete

Porte distributeur de savon en verre gravé

CODE / COEFFICIENT | CODICE /
COEFFICIENTE | CODE / COEFFICIENT

CC MO002CC 2,3

PACKAGING

L: 80 mm
 D: 130 mm
 H: 180 mm
 0,1 kg

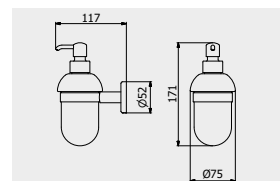

ARTICLE | ARTICOLO | ARTICLE

MO003

Wall toothbrush holder

Bicchieri porta spazzolino a parete

Porte-verre en verre gravé

CODE / COEFFICIENT | CODICE /
COEFFICIENTE | CODE / COEFFICIENT

CC MO003CC 1,5

PACKAGING

L: 70 mm
 D: 110 mm
 H: 100 mm
 0,4 kg

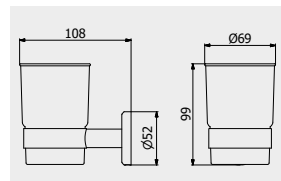

ARTICLE | ARTICOLO | ARTICLE

MO004

Towel holder

Porta salvietta

Porte-serviette

CODE / COEFFICIENT | CODICE /
COEFFICIENTE | CODE / COEFFICIENT

CC MO004CC 2,4

PACKAGING

L: 650 mm
 D: 70 mm
 H: 50 mm
 0,5 kg

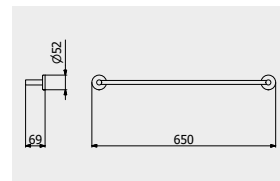

ARTICLE | ARTICOLO | ARTICLE

MO014

Towel holder

Porta salvietta

Porte-serviette

CODE / COEFFICIENT | CODICE /
COEFFICIENTE | CODE / COEFFICIENT

CC MO014CC 2,2

PACKAGING

L: 500 mm
 D: 70 mm
 H: 50 mm
 0,5 kg

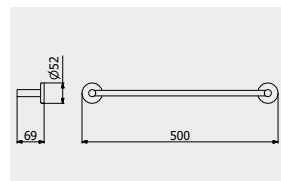

ARTICLE | ARTICOLO | ARTICLE

MO006

Towel holder

Porta salvietta

Porte-serviette

CODE / COEFFICIENT | CODICE /
COEFFICIENTE | CODE / COEFFICIENT

CC MO006CC 2,1

PACKAGING

L: 350 mm
 D: 70 mm
 H: 50 mm
 0,4 kg

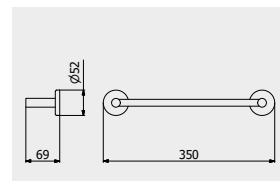

ARTICLE | ARTICOLO | ARTICLE

MO007

Ring Towel holder

Porta salvietta ad anello

Porte-serviettes anneau

CODE / COEFFICIENT | CODICE /
COEFFICIENTE | CODE / COEFFICIENT

CC MO007CC 1,6

PACKAGING

L: 180 mm 0,8 kg
D: 70 mm
H: 200 mm

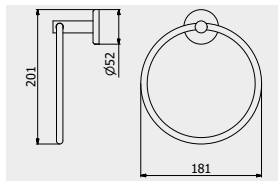

ARTICLE | ARTICOLO | ARTICLE

MO008

Robe Hook

Appendino a parete

Cintre

CODE / COEFFICIENT | CODICE /
COEFFICIENTE | CODE / COEFFICIENT

CC MO008CC 0,9

PACKAGING

L: 50 mm 0,3 kg
D: 50 mm
H: 50 mm

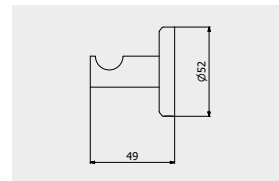

ARTICLE | ARTICOLO | ARTICLE

MO009

Double robe hook

Doppio appendino a parete

Double cintre

CODE / COEFFICIENT | CODICE /
COEFFICIENTE | CODE / COEFFICIENT

CC MO009CC 1,4

PACKAGING

L: 70 mm 0,1 kg
D: 70 mm
H: 50 mm

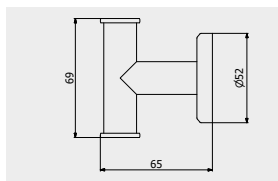

ARTICLE | ARTICOLO | ARTICLE

MO010

Shelf

Mensola

Etagère

CODE / COEFFICIENT | CODICE /
COEFFICIENTE | CODE / COEFFICIENT

CC MO010CC 3,0

PACKAGING

L: 600 mm 0,3 kg
D: 140 mm
H: 50 mm

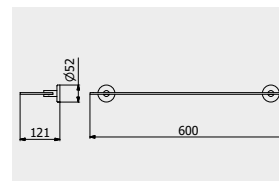

ARTICLE | ARTICOLO | ARTICLE

MO005

Swiveable towel holder

Porta salvietta doppio

Porte-serviettes noeud

CODE / COEFFICIENT | CODICE /
COEFFICIENTE | CODE / COEFFICIENT

CC MO005CC 3,5

PACKAGING

L: 430 mm 0,5 kg
D: 70 mm
H: 50 mm

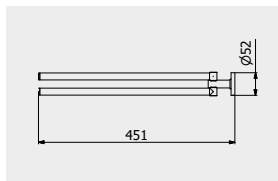

ARTICLE | ARTICOLO | ARTICLE

MO011

Toilet paper holder

Porta rotolo

Porte rouleaux de toilette

CODE / COEFFICIENT | CODICE /
COEFFICIENTE | CODE / COEFFICIENT

CC MO011CC 1,4

PACKAGING

L: 150 mm 0,2 kg
D: 70 mm
H: 50 mm

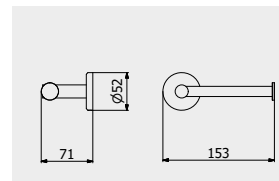

ARTICLE | ARTICOLO | ARTICLE

MO012

Toilet brush holder

Porta scopino da terra

Porte balayette au sol

CODE / COEFFICIENT | CODICE /
COEFFICIENTE | CODE / COEFFICIENT

CC MO012CC 2,5

PACKAGING

L: 80 mm 0,7 kg
D: 80 mm
H: 380 mm

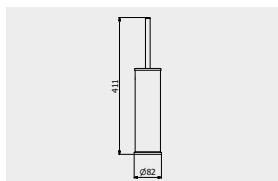

ARTICLE | ARTICOLO | ARTICLE

MO013

Wall toilet brush holder

Porta scopino da parete

Porte balayette

CODE / COEFFICIENT | CODICE /
COEFFICIENTE | CODE / COEFFICIENT

CC MO013CC 2,9

PACKAGING

L: 80 mm 0,7 kg
D: 80 mm
H: 380 mm

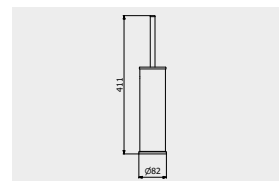

TWITTER

The bathroom collection that speaks to everyone.

TWITTER è la linea bagno che parla a tutti.
TWITTER est la ligne qui s'adresse à tous.

With its simple and delicate shapes, TWITTER is the bathroom collection that speaks to everyone, to the lovers of square lines as to those of the round forms, and it strikes for its essential refinement and delicate aesthetics. With its pleasing linear features, Twitter is the perfect collection for an sober and elegant bathroom.

Dalle forme semplici e delicate, TWITTER è la linea bagno che parla a tutti, agli amanti del tratto squadrato come a quelli della forma arrotondata, e colpisce per la sua essenziale ricercatezza e delicatezza estetica. Con le sue fattezze piacevoli e lineari, Twitter è la serie perfetta per un bagno sobrio ed elegante.

Avec ses formes simples et délicates, TWITTER est la ligne qui s'adresse à tous, aux amants de la ligne carrée comme à ceux de la forme arrondie, et frappe pour son raffinement essentiel et sa délicatesse esthétique. Avec ses formes agréables et linéaires, Twitter est la série parfaite pour une salle de bain sobre et élégante.



ANTI-LIMESCALE



CRYSTAL CLEAR
WATER



LEAD FREE



ZINC FREE



Twitter



DESIGN
LORENZO DAMIANI





← TW200NP
Monohole washbasin mixer
Miscelatore lavabo monoforo
Mitigreur lavabo

↑ TW220NP
Monohole bidet mixer
Miscelatore bidet monoforo
Mitigreur bidet



- ↑ TW200CC
Monohole washbasin mixer
Miscelatore lavabo monoforo
Mitigeur lavabo
- ← TW202CC
Tall monohole washbasin mixer
Miscelatore lavabo monoforo alto
Mitigeur lavabo haut
- TW200NP
Monohole washbasin mixer
Miscelatore lavabo monoforo
Mitigeur lavabo







↑ TW200NP
Monohole washbasin mixer
Miscelatore lavabo monoforo
Mitigeur lavabo

← TW399NP
Free-standing bath filler with shower kit
Bordo vasca da terra con kit doccia
Bain douche complet alimentation au sol



- ↖ **TW300CC**
Wall mounted washbasin mixer
Miscelatore doccia a parete una via
Mitigeur douche mural une voie
- ← **TW350CC**
Wall mounted shower mixer with shower kit
Doccia esterno a parete completo di kit doccia
Mitigeur de douche externe avec flexible et
douchette
- **TW313CC**
Two ways wall shower mixer with shower kit
Miscelatore doccia a parete con deviatore due
vie e doccino integrato
Mitigeur douche mural deux voies avec
inverseur et douchette encastrée



Twitter



← TW250CC
 Wall mounted bath filler with hand shower kit
 Bordo vasca esterno a parete con kit doccia
 Mitigeur Bain/douche Mural avec douchette
 encastrée

↙ TW396CC
 Four holes deck mounted bath filler with
 shower kit
 Bordo vasca quattro fori con deviatore e kit
 doccia
 Bain/douche quatre trous avec inverseur et
 Kit Douche

A Mixer	C Diverter
Miscelatore	Deviatore
Mitigeur	Déviateur
B Spout	D Hand shower
Bocca d'erogazione	Doccino
Bec	Douchette

→ TW399CC
 Free-standing bath filler with shower kit
 Bordo vasca da terra con kit doccia
 Bain douche complet alimentation au sol





Twitter

ARTICLE | ARTICOLO | ARTICLE

TW200



Monohole washbasin mixer complete with drain

Miscelatore lavabo monoforo completo di scarico automatico

Mitigeur lavabo complet avec bonde automatique

CODE / COEFFICIENT | CODICE /
COEFFICIENTE | CODE / COEFFICIENT

● CC	TW200CC	6,0
● SS	TW200SS	7,5
● BO	TW200BO	7,2
● NP	TW200NP	7,2
● CF	TW200CF	9,0
● CS	TW200CS	9,6
● II	TW200II	9,0
● IS	TW200IS	9,6
● RS	TW200RS	9,0
● SR	TW200SR	9,6
● OO	TW200OO	9,0
● OS	TW200OS	9,6

PACKAGING

L: 340 mm
D: 180 mm
H: 70 mm

1,7 kg

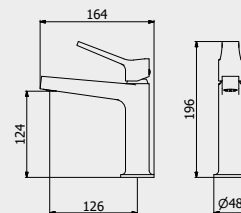

PORTATE | WATER FLOW | DÉBIT D'EAU

1 BAR	2 BAR	3 BAR
5,5 l/m	7,5 l/m	9,5 l/m

ARTICLE | ARTICOLO | ARTICLE

TW202



Tall monohole washbasin mixer complete with drain

Miscelatore lavabo monoforo alto completo di scarico automatico

Mitigeur lavabo haut complet avec bonde automatique

CODE / COEFFICIENT | CODICE /
COEFFICIENTE | CODE / COEFFICIENT

● CC	TW202CC	7,1
● SS	TW202SS	8,9
● BO	TW202BO	8,5
● NP	TW202NP	8,5
● CF	TW202CF	10,7
● CS	TW202CS	11,4
● II	TW202II	10,7
● IS	TW202IS	11,4
● RS	TW202RS	10,7
● SR	TW202SR	11,4
● OO	TW202OO	10,7
● OS	TW202OS	11,4

PACKAGING

L: 225 mm
D: 95 mm
H: 70 mm

2,2 kg

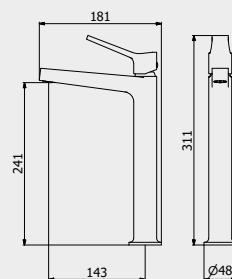

PORTATE | WATER FLOW | DÉBIT D'EAU

1 BAR	2 BAR	3 BAR
5,5 l/m	7,5 l/m	9,5 l/m

ARTICLE | ARTICOLO | ARTICLE

TW206



Wall mounted washbasin mixer complete with drain

Miscelatore lavabo due fori a parete completo di scarico automatico

Mitigeur lavabo mural complet avec bonde automatique

CODE / COEFFICIENT | CODICE /
COEFFICIENTE | CODE / COEFFICIENT

● CC	ETW206CC	8,8
● SS	ETW206SS	11,0
● BO	ETW206BO	10,6
● NP	ETW206NP	10,6
● CF	ETW206CF	13,2
● CS	ETW206CS	14,1
● II	ETW206II	13,2
● IS	ETW206IS	14,1
● RS	ETW206RS	13,2
● SR	ETW206SR	14,1
● OO	ETW206OO	13,2
● OS	ETW206OS	14,1

PACKAGING

L: 425 mm
D: 188 mm
H: 98 mm

3,7 kg

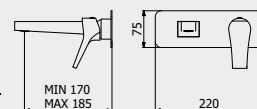

PORTATE | WATER FLOW | DÉBIT D'EAU

1 BAR	2 BAR	3 BAR
6,6 l/m	9,3 l/m	11,3 l/m

Built-in body to be purchased separately

Corpo incasso da acquistare separatamente

Corps intégré à acheter séparément



CODICE | CODE | CODE

INC206XXXN_19

COEFFICIENTE | COEFFICIENT | COEFFICIENT

2,9

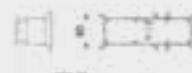

ARTICLE | ARTICOLO | ARTICLE

TW210



Ceiling spout with wall mounted mixer

Bocca da soffitto con comando remoto ad incasso

Mitigeur lavabo mural avec bec plafond complet avec bonde automatique

CODE / COEFFICIENT	CODICE / COEFFICIENTE	
CC	ETW210CC	27,5
SS	ETW210SS	34,4
BO	ETW210BO	33,0
NP	ETW210NP	33,0

PACKAGING

L: 150 mm
D: 190 mm
H: 98 mm

L: 1700 mm
Ø: 70 mm

4,5 kg

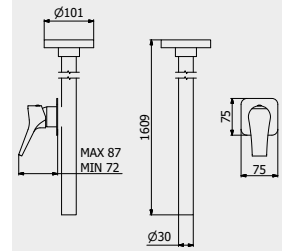

PORTATE | WATER FLOW | DÉBIT D'EAU

1 BAR	2 BAR	3 BAR
4,3 l/m	5,2 l/m	7 l/m

Built-in body to be purchased separately

Corpo incasso da acquistare separatamente

Corps intégré à acheter séparément



CODICE | CODE | CODE

INC300XXXN_19

COEFFICIENTE | COEFFICIENT | COEFFICIENT

1,8



Twitter

ARTICLE | ARTICOLO | ARTICLE

TW220



Monohole bidet mixer complete with drain

Miscelatore bidet monoforo completo di scarico automatico

Mitigeur bidet complet avec bonde automatique

CODE / COEFFICIENT	CODICE / COEFFICIENTE	
CC	TW220CC	6,0
SS	TW220SS	7,5
BO	TW220BO	7,2
NP	TW220NP	7,2
CF	TW220CF	9,0
CS	TW220CS	9,6
II	TW220II	9,0
IS	TW220IS	9,6
RS	TW220RS	9,0
SR	TW220SR	9,6
OO	TW220OO	9,0
OS	TW220OS	9,6

PACKAGING

L: 340 mm
D: 180 mm
H: 70 mm

1,6 kg

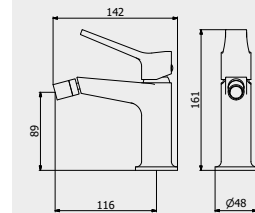

PORTATE | WATER FLOW | DÉBIT D'EAU

1 BAR	2 BAR	3 BAR
5,5 l/m	7,5 l/m	9,5 l/m

ARTICLE | ARTICOLO | ARTICLE

TW300



Exposed parts for manual wall mixer

Set di parti esterne per miscelatore a parete ad una via

Partie extérieure pour mitigeur encastré à une voie

CODE / COEFFICIENT	CODICE / COEFFICIENTE	
CC	ETW300CC	4,1
SS	ETW300SS	5,1
BO	ETW300BO	4,9
NP	ETW300NP	4,9
CF	ETW300CF	6,2
CS	ETW300CS	6,6
II	ETW300II	6,2
IS	ETW300IS	6,6
RS	ETW300RS	6,2
SR	ETW300SR	6,6
OO	ETW300OO	6,2
OS	ETW300OS	6,6

PACKAGING

L: 150 mm
D: 190 mm
H: 98 mm

1,7 kg

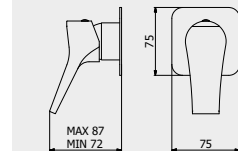

PORTATE | WATER FLOW | DÉBIT D'EAU

1 BAR	2 BAR	3 BAR
11,5 l/m	16,3 l/m	20 l/m

Built-in body to be purchased separately

Corpo incasso da acquistare separatamente

Corps intégré à acheter séparément



CODICE | CODE | CODE

INC300XXXN_19

COEFFICIENTE | COEFFICIENT | COEFFICIENT

1,8



ARTICLE | ARTICOLO | ARTICLE

TW310



Exposed parts for manual wall mixer with two ways diverter
 Miscelatore doccia a parete con deviatore due vie
 Mitigeur douche mural deux voies avec inverseur

CODE / COEFFICIENT	CODICE / COEFFICIENTE	CODE / COEFFICIENT
● CC	ETW310CC	6,1
● SS	ETW310SS	7,6
● BO	ETW310BO	7,3
● NP	ETW310NP	7,3
● CF	ETW310CF	9,2
● CS	ETW310CS	9,8
● II	ETW310II	9,2
● IS	ETW310IS	9,8
● RS	ETW310RS	9,2
● SR	ETW310SR	9,8
● OO	ETW310OO	9,2
● OS	ETW310OS	9,8

PACKAGING

L: 150 mm
D: 190 mm
H: 98 mm

1,7 kg

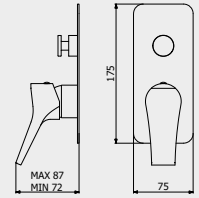

PORTATE | WATER FLOW | DÉBIT D'EAU

1 BAR	2 BAR	3 BAR
9,2 l/m	12,8 l/m	16 l/m

Built-in body to be purchased separately

Corpo incasso da acquistare separatamente

Corps intégré à acheter séparément



CODICE | CODE | CODE

INC310XXXN_19

COEFFICIENTE | COEFFICIENT | COEFFICIENT

3,3

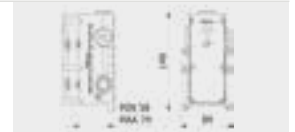

ARTICLE | ARTICOLO | ARTICLE

TW312



Exposed parts for manual wall mixer with three ways diverter
 Set di parti esterne per miscelatore a parete a tre vie
 Mitigeur douche mural trois voies avec inverseur

CODE / COEFFICIENT	CODICE / COEFFICIENTE	CODE / COEFFICIENT
● CC	ETW312CC	7,4
● SS	ETW312SS	9,3
● BO	ETW312BO	8,9
● NP	ETW312NP	8,9
● CF	ETW312CF	11,1
● CS	ETW312CS	11,8
● II	ETW312II	11,1
● IS	ETW312IS	11,8
● RS	ETW312RS	11,1
● SR	ETW312SR	11,8
● OO	ETW312OO	11,1
● OS	ETW312OS	11,8

PACKAGING

L: 150 mm
D: 190 mm
H: 98 mm

1,7 kg

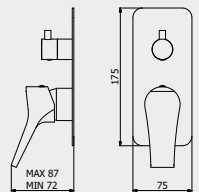

PORTATE | WATER FLOW | DÉBIT D'EAU

1 BAR	2 BAR	3 BAR
8,3 l/m	11,7 l/m	14,3 l/m

Built-in body to be purchased separately

Corpo incasso da acquistare separatamente

Corps intégré à acheter séparément



CODICE | CODE | CODE

INC312XXXN_19

COEFFICIENTE | COEFFICIENT | COEFFICIENT

3,3



ARTICLE | ARTICOLO | ARTICLE

TW313



Exposed parts for manual wall mixer with 2 ways with shower kit
 Set di parti esterne per miscelatore a parete a due vie completo di kit doccia
 Partie extérieure pour mitigeur encastré à deux voies avec douchette

CODE / COEFFICIENT	CODICE / COEFFICIENTE	CODE / COEFFICIENT
● CC	ETW313CC	10,1
● SS	ETW313SS	12,6
● BO	ETW313BO	12,1
● NP	ETW313NP	12,1
● CF	ETW313CF	15,2
● CS	ETW313CS	16,2
● II	ETW313II	15,2
● IS	ETW313IS	16,2
● RS	ETW313RS	15,2
● SR	ETW313SR	16,2
● OO	ETW313OO	15,2
● OS	ETW313OS	16,2

PACKAGING

L: 370 mm
D: 270 mm
H: 80 mm

2,1kg

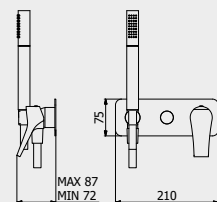

PORTATE | WATER FLOW | DÉBIT D'EAU

1 BAR	2 BAR	3 BAR
10 l/m	14,1 l/m	17,2 l/m

Built-in body to be purchased separately

Corpo incasso da acquistare separatamente

Corps intégré à acheter séparément



CODICE | CODE | CODE

INC313XXXN_19

COEFFICIENTE | COEFFICIENT | COEFFICIENT

3,6



ARTICLE | ARTICOLO | ARTICLE

TW314



Exposed parts for manual wall mixer with 3 ways with shower kit
Set di parti esterne per miscelatore a parete a tre vie completo di kit doccia
Partie extérieure pour mitigeur encastré à trois voies avec douchette

CODE / COEFFICIENT CODICE / COEFFICIENTE CODE / COEFFICIENT	
CC ETW314CC	11,4
SS ETW314SS	14,3
BO ETW314BO	13,7
NP ETW314NP	13,7
CF ETW314CF	17,1
CS ETW314CS	18,2
II ETW314II	17,1
IS ETW314IS	18,2
RS ETW314RS	17,1
SR ETW314SR	18,2
OO ETW314OO	17,1
OS ETW314OS	18,2

PACKAGING

L: 370 mm
D: 270 mm
H: 80 mm
2,1 kg

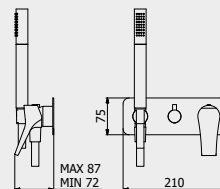

PORTATE | WATER FLOW | DÉBIT D'EAU

1 BAR	2 BAR	3 BAR
8,3 l/m	11,7 l/m	14,3 l/m

Built-in body to be purchased separately

Corpo incasso da acquistare separatamente

Corps intégré à acheter séparément



CODICE | CODE | CODE

INC314XXXN_19

COEFFICIENTE | COEFFICIENT | COEFFICIENT

3,7



ARTICLE | ARTICOLO | ARTICLE

TW396



Four holes deck mounted bath filler with shower kit
Bordo vasca quattro fori con deviatore e kit doccia
Bain quatre trous avec inverseur et Kit Douche

CODE / COEFFICIENT CODICE / COEFFICIENTE CODE / COEFFICIENT	
CC TW396CC	16,2
SS TW396SS	20,3
BO TW396BO	19,4
NP TW396NP	19,4
CF TW396CF	24,3
CS TW396CS	25,9
II TW396II	24,3
IS TW396IS	25,9
RS TW396RS	24,3
SR TW396SR	25,9
OO TW396OO	24,3
OS TW396OS	25,9

PACKAGING

L: 360 mm
D: 220 mm
H: 150 mm
4,4 kg

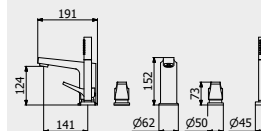

PORTATE | WATER FLOW | DÉBIT D'EAU

1 BAR	2 BAR	3 BAR
13,8 l/m	19,2 l/m	23,6 l/m

ARTICLE | ARTICOLO | ARTICLE

TW397



3 holes bath filler with overflow outlet connection, diverter and shower kit
Bordo vasca 3 fori per colonna riempimento con deviatore e kit doccia
Bain 3a trous avec inverseur et kit douche pour remplissage ETP

CODE / COEFFICIENT CODICE / COEFFICIENTE CODE / COEFFICIENT	
CC TW397CC	12,1
SS TW397SS	15,1
BO TW397BO	14,5
NP TW397NP	14,5
CF TW397CF	18,2
CS TW397CS	19,4
II TW397II	18,2
IS TW397IS	19,4
RS TW397RS	18,2
SR TW397SR	19,4
OO TW397OO	18,2
OS TW397OS	19,4

PACKAGING

L: 360 mm
D: 220 mm
H: 150 mm
3,3 kg

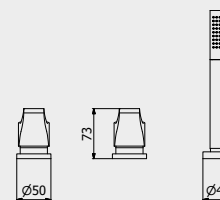

PORTATE | WATER FLOW | DÉBIT D'EAU

1 BAR	2 BAR	3 BAR
13,8 l/m	19,2 l/m	23,6 l/m

ARTICLE | ARTICOLO | ARTICLE

TW250



Wall mounted bath filler complete with hand shower kit
Bordo vasca esterno a parete completo di kit doccia
Mitigeur Bain/douche Mural avec douchette encastrée

CODE / COEFFICIENT CODICE / COEFFICIENTE CODE / COEFFICIENT	
CC TW250CC	7,4
SS TW250SS	9,3
BO TW250BO	8,9
NP TW250NP	8,9
CF TW250CF	11,1
CS TW250CS	11,8
II TW250II	11,1
IS TW250IS	11,8
RS TW250RS	11,1
SR TW250SR	11,8
OO TW250OO	11,1
OS TW250OS	11,8

PACKAGING

L: 370 mm
D: 270 mm
H: 80 mm
2,7 kg

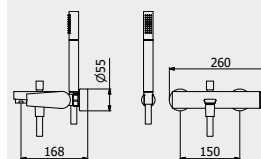

PORTATE | WATER FLOW | DÉBIT D'EAU

1 BAR	2 BAR	3 BAR
12 l/m	16,7 l/m	20,5 l/m

Twitter

ARTICLE | ARTICOLO | ARTICLE

TW350



Wall mounted shower mixer with shower kit

Doccia esterno a parete completo di kit doccia

Mitigeur de douche externe avec flexible et douchette

CODE / COEFFICIENTE	CODICE / CODE / COEFFICIENT	
● CC	TW350CC	6,6
● SS	TW350SS	8,3
● BO	TW350BO	7,9
● NP	TW350NP	7,9
● CF	TW350CF	9,9
● CS	TW350CS	10,6
● II	TW350II	9,9
● IS	TW350IS	10,6
● RS	TW350RS	9,9
● SR	TW350SR	10,6
● OO	TW350OO	9,9
● OS	TW350OS	10,6

PACKAGING

L: 340 mm
D: 180 mm
H: 70 mm

2,2 kg

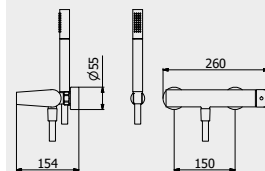

PORTATE | WATER FLOW | DÉBIT D'EAU

1 BAR	2 BAR	3 BAR
6 l/m	12 l/m	16 l/m

ARTICLE | ARTICOLO | ARTICLE

TW399



Free-standing bath filler with shower kit

Bordo vasca da terra con kit doccia

Bain douche complet alimentation au sol

CODE / COEFFICIENTE	CODICE / CODE / COEFFICIENT	
● CC	ETW399CC	26,9
● SS	ETW399SS	33,6
● BO	ETW399BO	32,3
● NP	ETW399NP	32,3
● CF	ETW399CF	40,4
● CS	ETW399CS	43,0
● II	ETW399II	40,4
● IS	ETW399IS	43,0
● RS	ETW399RS	40,4
● SR	ETW399SR	43,0
● OO	ETW399OO	40,4
● OS	ETW399OS	43,0

PACKAGING

L: 1100 mm
D: 395 mm
H: 150 mm

11,6 kg

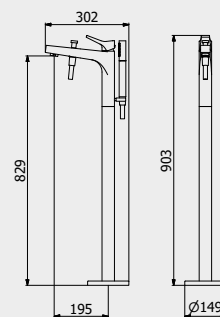

PORTATE | WATER FLOW | DÉBIT D'EAU

1 BAR	2 BAR	3 BAR
13,6 l/m	19,6 l/m	24 l/m

Built-in body to be purchased separately
AVAILABLE FROM JANUARY 2020

Corpo incasso da acquistare separatamente
DISPONIBILE DA GENNAIO 2020

Corps intégré à acheter séparément
DISPONIBLE À PARTIR DE JANVIER 2020



CODICE | CODE | CODE

INC399XXXN_19

COEFFICIENTE | COEFFICIENT | COEFFICIENT

2,8

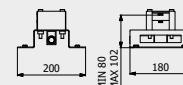

ARTICLE | ARTICOLO | ARTICLE

RU318



Built-in wall mounted waterfall spout

Cascata a parete con erogazione a lama esterna

Cascade murale avec bec externe

CODE / COEFFICIENTE	CODICE / CODE / COEFFICIENT	
● CC	RU318CC	22,9
● SS	RU318SS	28,6
● BO	RU318BO	27,5
● NP	RU318NP	27,5
● CF	RU318CF	34,4
● CS	RU318CS	36,6
● II	RU318II	34,4
● IS	RU318IS	36,6
● RS	RU318RS	34,4
● SR	RU318SR	36,6
● OO	RU318OO	34,4
● OS	RU318OS	36,6

PACKAGING

L: 340 mm
D: 180 mm
H: 70 mm

4,0 kg

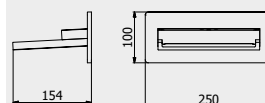

PORTATE | WATER FLOW | DÉBIT D'EAU

1 BAR	2 BAR	3 BAR
13 l/m	17 l/m	20 l/m



ARTICLE | ARTICOLO | ARTICLE

RU319



Wall mounted waterfall
Cascata a parete con erogazione diretta
Cascade murale

CODE / COEFFICIENT	CODICE / COEFFICIENTE	COEFFICIENT
CC	RU319CC	12,8
SS	RU319SS	16,0
BO	RU319BO	15,4
NP	RU319NP	15,4
CF	RU319CF	19,2
CS	RU319CS	20,5
II	RU319II	19,2
IS	RU319IS	20,5
RS	RU319RS	19,2
SR	RU319SR	20,5
OO	RU319OO	19,2
OS	RU319OS	20,5

PACKAGING

L: 340 mm
D: 180 mm
H: 70 mm
3,1 kg

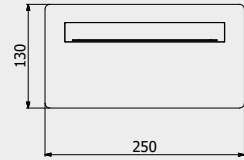

PORTATE | WATER FLOW | DÉBIT D'EAU

1 BAR	2 BAR	3 BAR
13 l/m	17 l/m	20 l/m

ARTICLE | ARTICOLO | ARTICLE

TW320



Wall mounted spout
Bocca d'erogazione corta a parete
Bec de remplissage mural court

CODE / COEFFICIENT	CODICE / COEFFICIENTE	COEFFICIENT
CC	TW320CC	5,0
SS	TW320SS	6,3
BO	TW320BO	6,0
NP	TW320NP	6,0
CF	TW320CF	7,5
CS	TW320CS	8,0
II	TW320II	7,5
IS	TW320IS	8,0
RS	TW320RS	7,5
SR	TW320SR	8,0
OO	TW320OO	7,5
OS	TW320OS	8,0

PACKAGING

L: 150 mm
D: 190 mm
H: 98 mm
1,0 kg

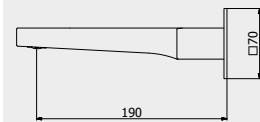

PORTATE | WATER FLOW | DÉBIT D'EAU

1 BAR	2 BAR	3 BAR
8,8 l/m	12,5 l/m	15 l/m

ARTICLE | ARTICOLO | ARTICLE

TW706



Exposed parts for bidet spray complete with mixer
Set di parti esterne per Idroscopino igienico con miscelatore
Partie extérieure pour douchette hygiénique avec mitigeur

CODE / COEFFICIENT	CODICE / COEFFICIENTE	COEFFICIENT
CC	ETW706CC	9,8
SS	ETW706SS	12,3
BO	ETW706BO	11,8
NP	ETW706NP	11,8
CF	ETW706CF	14,7
CS	ETW706CS	15,7
II	ETW706II	14,7
IS	ETW706IS	15,7
RS	ETW706RS	14,7
SR	ETW706SR	15,7
OO	ETW706OO	14,7
OS	ETW706OS	15,7

PACKAGING

L: 370 mm
D: 270 mm
H: 80 mm
3,1 kg

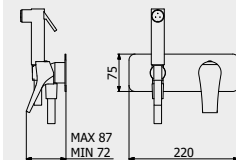

PORTATE | WATER FLOW | DÉBIT D'EAU

1 BAR	2 BAR	3 BAR
2,3 l/m	3,2 l/m	4 l/m

Built-in body to be purchased separately

Corpo incasso da acquistare separatamente

Corps intégré à acheter séparément



CODICE | CODE | CODE

INC206XXXN_19

COEFFICIENTE | COEFFICIENT | COEFFICIENT

2,9

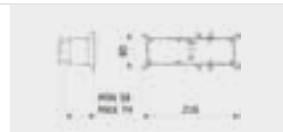

MODERNA / ACCESSORIES COLLECTION

ARTICLE | ARTICOLO | ARTICLE

MO001

Wall soap-holder

Porta sapone a muro

Porte distributeur de savon encastré

CODE / COEFFICIENT | CODICE /
COEFFICIENTE | CODE / COEFFICIENT

CC MO001CC 1,5

PACKAGING

L: 110 mm
 D: 130 mm
 H: 50 mm
 0,4 kg

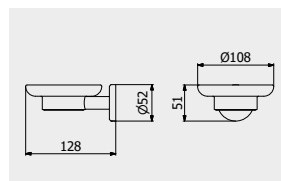

ARTICLE | ARTICOLO | ARTICLE

MO002

Wall soap dispenser holder

Porta dispenser sapone liquido a parete

Porte distributeur de savon en verre gravé

CODE / COEFFICIENT | CODICE /
COEFFICIENTE | CODE / COEFFICIENT

CC MO002CC 2,3

PACKAGING

L: 80 mm
 D: 130 mm
 H: 180 mm
 0,1 kg

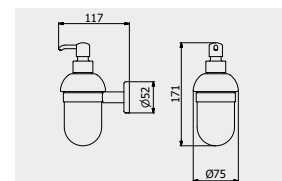

ARTICLE | ARTICOLO | ARTICLE

MO003

Wall toothbrush holder

Bicchiere porta spazzolino a parete

Porte-verre en verre gravé

CODE / COEFFICIENT | CODICE /
COEFFICIENTE | CODE / COEFFICIENT

CC MO003CC 1,5

PACKAGING

L: 70 mm
 D: 110 mm
 H: 100 mm
 0,4 kg

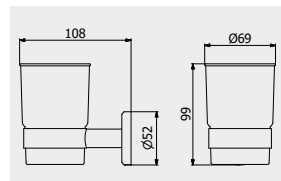

ARTICLE | ARTICOLO | ARTICLE

MO004

Towel holder

Porta salvietta

Porte-serviette

CODE / COEFFICIENT | CODICE /
COEFFICIENTE | CODE / COEFFICIENT

CC MO004CC 2,4

PACKAGING

L: 650 mm
 D: 70 mm
 H: 50 mm
 0,5 kg

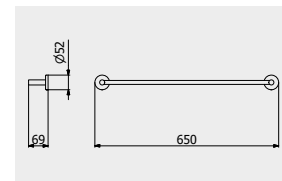

ARTICLE | ARTICOLO | ARTICLE

MO014

Towel holder

Porta salvietta

Porte-serviette

CODE / COEFFICIENT | CODICE /
COEFFICIENTE | CODE / COEFFICIENT

CC MO014CC 2,2

PACKAGING

L: 500 mm
 D: 70 mm
 H: 50 mm
 0,5 kg

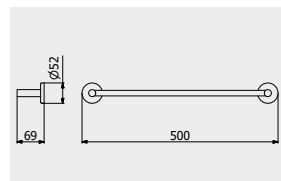

ARTICLE | ARTICOLO | ARTICLE

MO006

Towel holder

Porta salvietta

Porte-serviette

CODE / COEFFICIENT | CODICE /
COEFFICIENTE | CODE / COEFFICIENT

CC MO006CC 2,1

PACKAGING

L: 350 mm
 D: 70 mm
 H: 50 mm
 0,4 kg

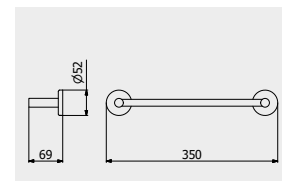

ARTICLE | ARTICOLO | ARTICLE

MO007

Ring Towel holder

Porta salvietta ad anello

Porte-serviettes anneau

CODE / COEFFICIENT | CODICE /
COEFFICIENTE | CODE / COEFFICIENT

CC **MO007CC** 1,6

PACKAGING

L: 180 mm 0,8 kg
D: 70 mm
H: 200 mm

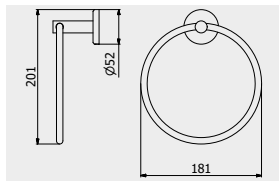

ARTICLE | ARTICOLO | ARTICLE

MO008

Robe Hook

Appendino a parete

Cintre

CODE / COEFFICIENT | CODICE /
COEFFICIENTE | CODE / COEFFICIENT

CC **MO008CC** 0,9

PACKAGING

L: 50 mm 0,3 kg
D: 50 mm
H: 50 mm

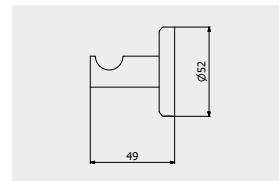

ARTICLE | ARTICOLO | ARTICLE

MO009

Double robe hook

Doppio appendino a parete

Double cintre

CODE / COEFFICIENT | CODICE /
COEFFICIENTE | CODE / COEFFICIENT

CC **MO009CC** 1,4

PACKAGING

L: 70 mm 0,1 kg
D: 70 mm
H: 50 mm

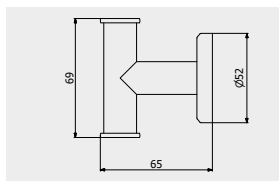

ARTICLE | ARTICOLO | ARTICLE

MO010

Shelf

Mensola

Etagère

CODE / COEFFICIENT | CODICE /
COEFFICIENTE | CODE / COEFFICIENT

CC **MO010CC** 3,0

PACKAGING

L: 600 mm 0,3 kg
D: 140 mm
H: 50 mm

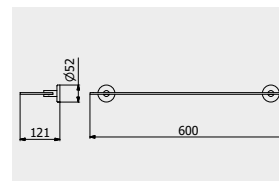

ARTICLE | ARTICOLO | ARTICLE

MO005

Swiveable towel holder

Porta salvietta doppio

Porte-serviettes noeud

CODE / COEFFICIENT | CODICE /
COEFFICIENTE | CODE / COEFFICIENT

CC **MO005CC** 3,5

PACKAGING

L: 430 mm 0,5 kg
D: 70 mm
H: 50 mm

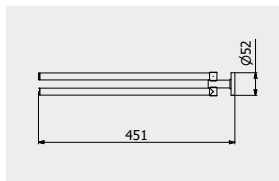

ARTICLE | ARTICOLO | ARTICLE

MO011

Toilet paper holder

Porta rotolo

Porte rouleaux de toilette

CODE / COEFFICIENT | CODICE /
COEFFICIENTE | CODE / COEFFICIENT

CC **MO011CC** 1,4

PACKAGING

L: 150 mm 0,2 kg
D: 70 mm
H: 50 mm

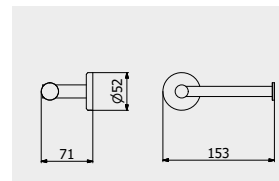

ARTICLE | ARTICOLO | ARTICLE

MO012

Toilet brush holder

Porta scopino da terra

Porte balayette au sol

CODE / COEFFICIENT | CODICE /
COEFFICIENTE | CODE / COEFFICIENT

CC **MO012CC** 2,5

PACKAGING

L: 80 mm 0,7 kg
D: 80 mm
H: 380 mm

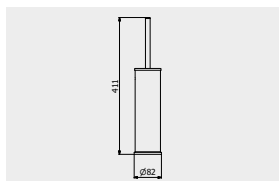

ARTICLE | ARTICOLO | ARTICLE

MO013

Wall toilet brush holder

Porta scopino da parete

Porte balayette

CODE / COEFFICIENT | CODICE /
COEFFICIENTE | CODE / COEFFICIENT

CC **MO013CC** 2,9

PACKAGING

L: 80 mm 0,7 kg
D: 80 mm
H: 380 mm

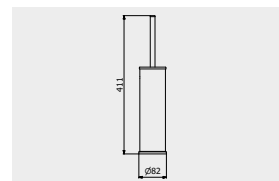

SUPERBOX

It make even the simplest and everyday gesture funny and thrilling.

Rende divertente e stimolante anche il gesto più semplice e quotidiano.
Il rend amusants et stimulants même les gestes les plus simples et quotidiens.

There are simple faucets, and then there's Supebox. This collection is able to make even the simplest and everyday gesture funny and thrilling. An innovative and exciting joystick lever steers the water pouring, just like a video game. The absence of an aerator allows the water to flow neatly and sharply from the spout, as fast as a superhero's blade.

Esistono dei semplici rubinetti, e poi c'è Supebox. Questa linea rende divertente e stimolante anche il gesto più semplice e quotidiano. La fuoriuscita dell'acqua è pilotata da una leva a joystick innovativa e appassionante, proprio come un videogioco. L'assenza di aeratore permette all'acqua di fluire dalla bocca in maniera decisa e tagliente, veloce come la lama di un supereroe.

Il y a des robinets simples, et puis il y a Supebox. Cette collection rend amusants et stimulants même les gestes les plus simples et quotidiens. L'écoulement d'eau est piloté par un levier joystick innovateur et passionnant, à la manière d'un jeu vidéo. L'absence d'aérateur permet à l'eau de s'écouler de la bouche de façon résolue et nette, aussi rapide que l'épée d'un super-héros.



KITCHEN
AVAILABLE



CRYSTAL CLEAR
WATER



LEAD FREE



ZINC FREE



Superbox



DESIGN
CRESCENT DESIGN

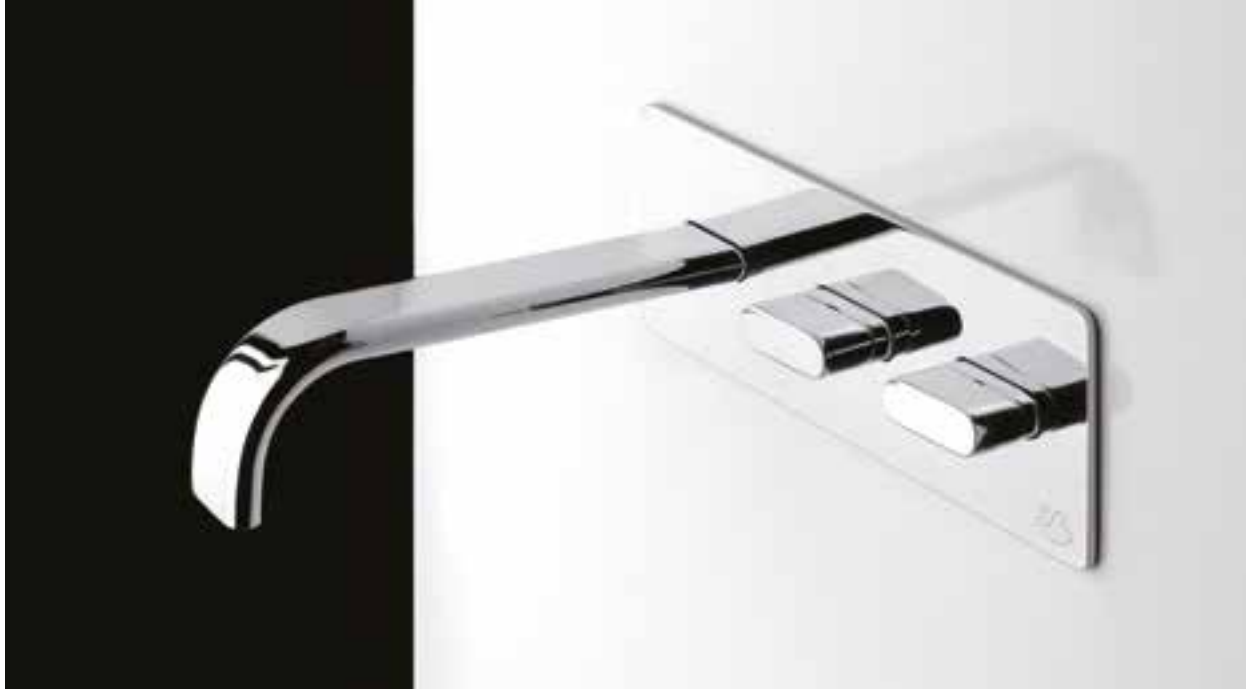

- ↑ SB306CC
Wall mounted widespread lavatory faucet
Rubinetto lavabo da incasso
Robinet de lavabo mural
- ↙ SB200CC
Monohole washbasin mixer
Miscelatore lavabo monoforo
Mitigeur lavabo complet
- SB202CC
Tall monohole washbasin mixer
Miscelatore lavabo monoforo alto
Mitigeur lavabo haut







Superbox

← SB390CC
Three holes washbasin set with tall spout
Lavabo tre fori bocca alta completo
Lavabo trois trous bec haut

↗ SB220CC
Monohole bidet mixer
Miscelatore bidet monoforo
Mitigeur bidet complet

→ SB300CC
One way wall shower mixer
Miscelatore doccia a parete una via
Mitigeur douche mural une voie







Superbox

← SB250CC
 Wall mounted bath filler with hand shower kit
 Bordo vasca esterno a parete con kit doccia
 Mitigeur Bain/douche Mural avec douchette
 encastrée

↑ SB396CC
 Five holes deck mounted bath filler with
 shower kit
 Bordo vasca cinque fori con deviatore e kit
 doccia
 Bain/douche cinq trous avec inverseur et Kit
 Douche

- | | | | |
|----------|---|----------|--|
| A | Hot water
Acqua calda
Eau chaude | D | Diverter
Deviatore
Déviateur |
| B | Spout
Bocca d'erogazione
Bec | E | Hand shower
Doccino
Douchette |
| C | Cold water
Acqua fredda
Eau froide | | |

→ SB350CC
 Wall mounted shower mixer with shower kit
 Doccia esterno a parete con kit doccia
 Mitigeur de douche externe avec flexible et
 douchette



ARTICLE | ARTICOLO | ARTICLE

SB200



Monohole washbasin mixer complete with drain

Miscelatore lavabo monoforo completo di scarico automatico

Mitigeur lavabo complet avec bonde automatique

CODICE / COEFFICIENTE | CODE /
COEFFICIENT | CODE / COEFFICIENT

● CC	SB200CC	12,2
● SS	SB200SS	15,3
● NP	SB200NP	14,6
● OS	SB200OS	19,5
● RS	SB200RS	18,3
● ON	SB200ON	12,2

PACKAGING

 L: 225 mm
D: 95 mm
H: 70 mm

2,6 kg

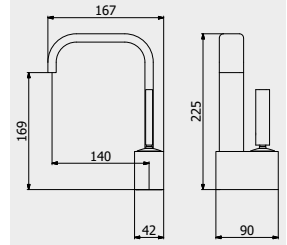

PORTATE | WATER FLOW | DÉBIT D'EAU

1 BAR	2 BAR	3 BAR
8 l/m	11 l/m	13 l/m

ARTICLE | ARTICOLO | ARTICLE

SB202



Tall monohole washbasin mixer complete with drain

Miscelatore lavabo monoforo alto completo di scarico automatico

Mitigeur lavabo haut complet avec bonde automatique

CODICE / COEFFICIENTE | CODE /
COEFFICIENT | CODE / COEFFICIENT

● CC	SB202CC	12,6
● SS	SB202SS	15,8
● NP	SB202NP	15,1
● OS	SB202OS	20,2
● RS	SB202RS	18,9
● ON	SB202ON	12,6

PACKAGING

 L: 225 mm
D: 95 mm
H: 70 mm

2,8 kg

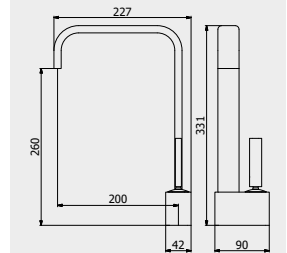

PORTATE | WATER FLOW | DÉBIT D'EAU

1 BAR	2 BAR	3 BAR
8 l/m	11 l/m	13 l/m

ARTICLE | ARTICOLO | ARTICLE

SB306



Wall mounted widespread lavatory faucet

Rubinetto lavabo da incasso

Robinet de lavabo mural

CODICE / COEFFICIENTE | CODE /
COEFFICIENT | CODE / COEFFICIENT

● CC	SB306CC	15,1
● SS	SB306SS	18,9
● NP	SB306NP	18,1
● OS	SB306OS	24,2
● RS	SB306RS	22,7
● ON	SB306ON	15,1

PACKAGING

 L: 265 mm
D: 260 mm
H: 70 mm

1,9 kg

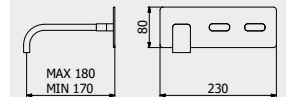

PORTATE | WATER FLOW | DÉBIT D'EAU

1 BAR	2 BAR	3 BAR
10 l/m	10,5 l/m	11 l/m

ARTICLE | ARTICOLO | ARTICLE

SB307



Wall mounted widespread lavatory faucet with long spout

Rubinetto lavabo da incasso a bocca lunga

Robinet de lavabo mural avec bec long

CODICE / COEFFICIENTE | CODE /
COEFFICIENT | CODE / COEFFICIENT

● CC	SB307CC	15,4
● SS	SB307SS	19,3
● NP	SB307NP	18,5
● OS	SB307OS	24,6
● RS	SB307RS	23,1
● ON	SB307ON	15,4

PACKAGING

 L: 265 mm
D: 260 mm
H: 70 mm

1,9 kg

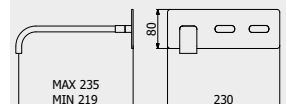

PORTATE | WATER FLOW | DÉBIT D'EAU

1 BAR	2 BAR	3 BAR
10,3 l/m	10,5 l/m	10,7 l/m



ARTICLE | ARTICOLO | ARTICLE

SB308



Wall mounted washbasin mixer with short spout complete with drain
 Miscelatore lavabo a parete con bocca corta completo di scarico
 Mitigeur lavabo mural bec court complet avec bonde automatique

CODICE / COEFFICIENTE CODE / COEFFICIENT	
CC	SB308CC 15,4
SS	SB308SS 19,3
NP	SB308NP 18,5
OS	SB308OS 24,6
RS	SB308RS 23,1
ON	SB308ON 15,4

PACKAGING

L: 265 mm
 D: 260 mm
 H: 70 mm
 1,9 kg

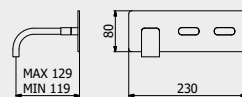

PORTATE | WATER FLOW | DÉBIT D'EAU

1 BAR	2 BAR	3 BAR
10,3 l/m	10,5 l/m	10,7 l/m

ARTICLE | ARTICOLO | ARTICLE

SB210



Ceiling spout with wall mounted mixer
 Bocca da soffitto con comando remoto ad incasso
 Mitigeur lavabo mural avec bec plafond complet avec bonde automatique

CODICE / COEFFICIENTE CODE / COEFFICIENT	
CC	ESB210CC 27,5
SS	ESB210SS 34,4
NP	ESB210NP 33,0
RS	ESB210RS 41,3

PACKAGING

L: 150 mm
 D: 190 mm
 H: 98 mm
 L: 1700 mm
 Ø: 70 mm
 4,5 kg

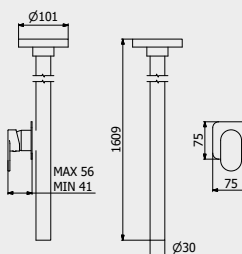

PORTATE | WATER FLOW | DÉBIT D'EAU

1 BAR	2 BAR	3 BAR
4,3 l/m	5,2 l/m	7 l/m

Superbox

Built-in body to be purchased separately

Corpo incasso da acquistare separatamente

Corps intégré à acheter séparément



CODICE | CODE | CODE

INC300XXXN_19

COEFFICIENTE | COEFFICIENT | COEFFICIENT

1,8



ARTICLE | ARTICOLO | ARTICLE

SB390



Three holes washbasin set with tall spout
 Lavabo tre fori bocca alta completo di scarico automatico
 Lavabo trois trous bec haut

CODICE / COEFFICIENTE CODE / COEFFICIENT	
CC	SB390CC 13,8
SS	SB390SS 17,3
NP	SB390NP 16,6
OS	SB390OS 22,1
RS	SB390RS 20,7
ON	SB390ON 13,8

PACKAGING

L: 455 mm
 D: 310 mm
 H: 75 mm
 3,2 kg

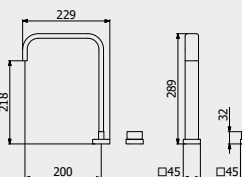

PORTATE | WATER FLOW | DÉBIT D'EAU

1 BAR	2 BAR	3 BAR
10 l/m	10,5 l/m	11,5 l/m

ARTICLE | ARTICOLO | ARTICLE

SB392



Three holes washbasin set with low spout

Lavabo tre fori a bocca bassa completo di scarico automatico

Lavabo trois trous bec bas

CODICE / COEFFICIENTE | CODE /
COEFFICIENT | CODE / COEFFICIENT

●	CC	SB392CC	12,6
●	SS	SB392SS	15,8
●	NP	SB392NP	15,1
●	OS	SB392OS	20,2
●	RS	SB392RS	18,9
●	ON	SB392ON	12,6

PACKAGING

L: 455 mm
D: 310 mm
H: 75 mm

3 kg

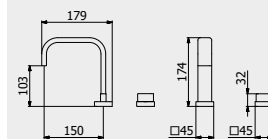

PORTATE | WATER FLOW | DÉBIT D'EAU

1 BAR	2 BAR	3 BAR
10 l/m	10,5 l/m	11,5 l/m

ARTICLE | ARTICOLO | ARTICLE

SB220



Monohole bidet mixer complete with drain

Miscelatore bidet monoforo completo di scarico automatico

Mitigeur bidet complet avec bonde automatique

CODICE / COEFFICIENTE | CODE /
COEFFICIENT | CODE / COEFFICIENT

●	CC	SB220CC	12,2
●	SS	SB220SS	15,3
●	NP	SB220NP	14,6
●	OS	SB220OS	19,5
●	RS	SB220RS	18,3
●	ON	SB220ON	12,2

PACKAGING

L: 225 mm
D: 95 mm
H: 70 mm

2,6 kg

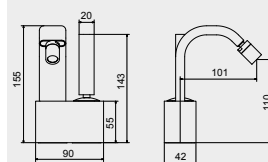

PORTATE | WATER FLOW | DÉBIT D'EAU

1 BAR	2 BAR	3 BAR
8 l/m	11 l/m	13 l/m

ARTICLE | ARTICOLO | ARTICLE

SB300



Exposed parts for manual wall mixer

Set di parti esterne per miscelatore a parete ad una via

Partie extérieure pour mitigeur encastré à une voie

CODICE / COEFFICIENTE | CODE /
COEFFICIENT | CODE / COEFFICIENT

●	CC	ESB300CC	4,1
●	SS	ESB300SS	5,1
●	NP	ESB300NP	4,9
●	OS	ESB300OS	6,6
●	RS	ESB300RS	6,2
●	ON	ESB300ON	4,1

PACKAGING

L: 150 mm
D: 190 mm
H: 98 mm

1,9 kg

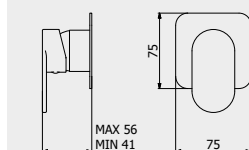

PORTATE | WATER FLOW | DÉBIT D'EAU

1 BAR	2 BAR	3 BAR
11,5 l/m	10,3 l/m	20 l/m

Built-in body to be purchased separately

Corpo incasso da acquistare separatamente

Corps intégré à acheter séparément



CODICE | CODE | CODE

INC300XXXN_19

COEFFICIENTE | COEFFICIENT | COEFFICIENT

1,8



ARTICLE | ARTICOLO | ARTICLE

SB310



Exposed parts for manual wall mixer with two ways diverter
 Miscelatore doccia a parete con deviatore due vie
 Mitigeur douche mural deux voies avec inverseur

CODICE / COEFFICIENTE CODE / COEFFICIENT		
CC	ESB310CC	6,1
SS	ESB310SS	7,6
NP	ESB310NP	7,3
OS	ESB310OS	9,8
RS	ESB310RS	9,2
ON	ESB310ON	6,1

PACKAGING
 L: 150 mm
 D: 190 mm
 H: 98 mm
 1,9 kg

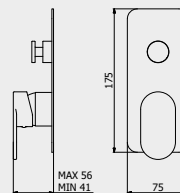

PORTATE | WATER FLOW | DÉBIT D'EAU

1 BAR	2 BAR	3 BAR
9,2 l/m	12,8 l/m	16 l/m

Built-in body to be purchased separately
 Corpo incasso da acquistare separatamente
 Corps intégré à acheter séparément



CODICE | CODE | CODE

INC310XXXN_19

COEFFICIENTE | COEFFICIENT | COEFFICIENT

3,3



ARTICLE | ARTICOLO | ARTICLE

SB312



Exposed parts for manual wall mixer with three ways diverter
 Set di parti esterne per miscelatore a parete a tre vie
 Mitigeur douche mural trois voies avec inverseur

CODICE / COEFFICIENTE CODE / COEFFICIENT		
CC	ESB312CC	7,4
SS	ESB312SS	9,3
NP	ESB312NP	8,9
OS	ESB312OS	11,8
RS	ESB312RS	11,1
ON	ESB312ON	7,4

PACKAGING
 L: 150 mm
 D: 190 mm
 H: 98 mm
 1,9 kg

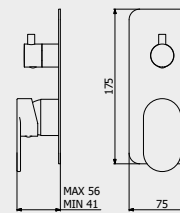

PORTATE | WATER FLOW | DÉBIT D'EAU

1 BAR	2 BAR	3 BAR
8,3 l/m	11,7 l/m	14,3 l/m

Built-in body to be purchased separately
 Corpo incasso da acquistare separatamente
 Corps intégré à acheter séparément



CODICE | CODE | CODE

INC312XXXN_19

COEFFICIENTE | COEFFICIENT | COEFFICIENT

3,3



Superbox

ARTICLE | ARTICOLO | ARTICLE

SB313



Exposed parts for manual wall mixer with 2 ways with shower kit
 Set di parti esterne per miscelatore a parete a due vie completo di kit doccia
 Partie extérieure pour mitigeur encastré à deux voies avec douchette

CODICE / COEFFICIENTE CODE / COEFFICIENT		
CC	ESB313CC	10,1
SS	ESB313SS	12,6
NP	ESB313NP	12,1
OS	ESB313OS	16,2
RS	ESB313RS	15,2
ON	ESB313ON	10,1

PACKAGING
 L: 370 mm
 D: 270 mm
 H: 80 mm
 2,1 kg

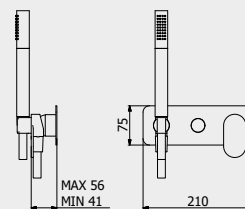

PORTATE | WATER FLOW | DÉBIT D'EAU

1 BAR	2 BAR	3 BAR
10 l/m	14,1 l/m	17,2 l/m

Built-in body to be purchased separately
 Corpo incasso da acquistare separatamente
 Corps intégré à acheter séparément



CODICE | CODE | CODE

INC313XXXN_19

COEFFICIENTE | COEFFICIENT | COEFFICIENT

3,6



ARTICLE | ARTICOLO | ARTICLE

SB314



Exposed parts for manual wall mixer with 3 ways with shower kit
Set di parti esterne per miscelatore a parete a tre vie completo di kit doccia
Partie extérieure pour mitigeur encastré à trois voies avec douchette

CODICE / COEFFICIENTE | CODE / COEFFICIENT

CC	ESB314CC	11,4
SS	ESB314SS	14,3
NP	ESB314NP	13,7
OS	ESB314OS	18,2
RS	ESB314RS	17,1
ON	ESB314ON	11,4

PACKAGING

L: 370 mm
D: 270 mm
H: 80 mm

2,1 kg

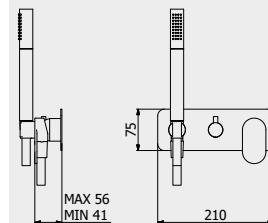
**PORTATE | WATER FLOW | DÉBIT D'EAU**

1 BAR	2 BAR	3 BAR
8,3 l/m	11,7 l/m	14,3 l/m

Built-in body to be purchased separately

Corpo incasso da acquistare separatamente

Corps intégré à acheter séparément

**CODICE | CODE | CODE****INC314XXXN_19****COEFFICIENTE | COEFFICIENT | COEFFICIENT**

3,7

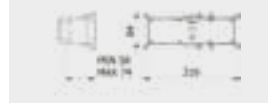

ARTICLE | ARTICOLO | ARTICLE

SB250



Wall mounted bath filler complete with hand shower kit
Bordo vasca esterno a parete completo di kit doccia
Mitigeur bain/douche mural avec douchette encastrée

CODICE / COEFFICIENTE | CODE / COEFFICIENT

CC	SB250CC	16,9
SS	SB250SS	21,1
NP	SB250NP	20,3
OS	SB250OS	27,0
RS	SB250RS	25,4
ON	SB250ON	16,9

PACKAGING

L: 370 mm
D: 270 mm
H: 80 mm

4,4 kg

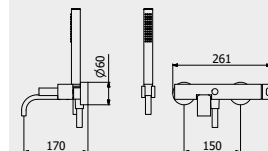
**PORTATE | WATER FLOW | DÉBIT D'EAU**

1 BAR	2 BAR	3 BAR
10 l/m	14 l/m	17 l/m

ARTICLE | ARTICOLO | ARTICLE

SB396



Five holes deck mounted bath filler with shower kit
Bordo vasca cinque fori con deviatore e kit doccia
Bain/douche cinq trous avec inverseur et kit douche

CODICE / COEFFICIENTE | CODE / COEFFICIENT

CC	SB396CC	21,4
SS	SB396SS	26,8
NP	SB396NP	25,7
OS	SB396OS	34,2
RS	SB396RS	32,1
ON	SB396ON	21,4

PACKAGING

L: 400 mm
D: 250 mm
H: 140 mm

5,0 kg

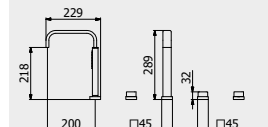
**PORTATE | WATER FLOW | DÉBIT D'EAU**

1 BAR	2 BAR	3 BAR
21 l/m	29 l/m	36 l/m

ARTICLE | ARTICOLO | ARTICLE

SB397



4 holes bath filler with overflow outlet connection, and shower kit
Bordo vasca 4 fori per colonna riempimento con deviatore e kit doccia
Bain quatre trous avec inverseur et kit douche pour remplissage ETP

CODICE / COEFFICIENTE | CODE / COEFFICIENT

CC	SB397CC	14,7
SS	SB397SS	18,4
NP	SB397NP	17,6
OS	SB397OS	23,5
RS	SB397RS	22,1
ON	SB397ON	14,7

PACKAGING

L: 370 mm
D: 270 mm
H: 80 mm

4 kg

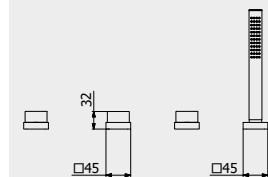
**PORTATE | WATER FLOW | DÉBIT D'EAU**

1 BAR	2 BAR	3 BAR
21 l/m	29 l/m	36 l/m



ARTICLE | ARTICOLO | ARTICLE

SB350



Wall mounted shower mixer with shower kit

Doccia esterno a parete completo di kit doccia

Mitigeur de douche externe avec flexible et douchette

CODICE / COEFFICIENTE | CODICE / COEFFICIENTE

CC	SB350CC	12,1
SS	SB350SS	15,1
NP	SB350NP	14,5
OS	SB350OS	19,4
RS	SB350RS	18,2
ON	SB350ON	12,1

PACKAGING

L: 370 mm
D: 270 mm
H: 80 mm
4,1 kg

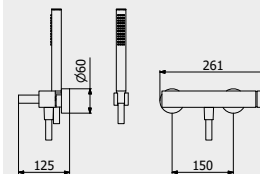

PORTATE | WATER FLOW | DÉBIT D'EAU

1 BAR	2 BAR	3 BAR
12,5 l/m	18 l/m	21 l/m

ARTICLE | ARTICOLO | ARTICLE

RU318



Built-in wall mounted waterfall spout

Cascata a parete con erogazione a lama esterna

Cascade murale avc bec externe

CODE / COEFFICIENT | CODICE / COEFFICIENT

CC	RU318CC	22,9
SS	RU318SS	28,6
BO	RU318BO	27,5
NP	RU318NP	27,5
CF	RU318CF	34,4
CS	RU318CS	36,6
II	RU318II	34,4
IS	RU318IS	36,6
RS	RU318RS	34,4
SR	RU318SR	36,6
OO	RU318OO	34,4
OS	RU318OS	36,6

PACKAGING

L: 340 mm
D: 180 mm
H: 70 mm
4,0 kg

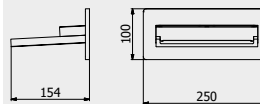

PORTATE | WATER FLOW | DÉBIT D'EAU

1 BAR	2 BAR	3 BAR
13 l/m	17 l/m	20 l/m

Superbox

ARTICLE | ARTICOLO | ARTICLE

RU319



Wall mounted waterfall

Cascata a parete con erogazione diretta

Cascade murale

CODICE / COEFFICIENT | CODICE / COEFFICIENT

CC	RU319CC	12,8
SS	RU319SS	16,0
BO	RU319BO	15,4
NP	RU319NP	15,4
CF	RU319CF	19,2
CS	RU319CS	20,5
II	RU319II	19,2
IS	RU319IS	20,5
RS	RU319RS	19,2
SR	RU319SR	20,5
OO	RU319OO	19,2
OS	RU319OS	20,5

PACKAGING

L: 340 mm
D: 180 mm
H: 70 mm
3,1 kg

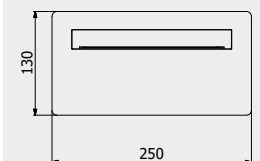

PORTATE | WATER FLOW | DÉBIT D'EAU

1 BAR	2 BAR	3 BAR
13 l/m	17 l/m	20 l/m

ARTICLE | ARTICOLO | ARTICLE

SB320



Wall mounted spout

Bocca d'erogazione corta a parete

Bec de remplissage mural court

CODICE / COEFFICIENTE | CODICE / COEFFICIENTE

CC	SB320CC	4,7
SS	SB320SS	5,9
NP	SB320NP	5,6
OS	SB320OS	7,5
RS	SB320RS	7,1
ON	SB320ON	4,7

PACKAGING

L: 210 mm
D: 130 mm
H: 70 mm
0,5 kg

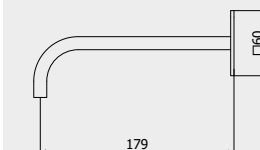

PORTATE | WATER FLOW | DÉBIT D'EAU

1 BAR	2 BAR	3 BAR
10 l/m	11 l/m	12,5 l/m

ARTICLE | ARTICOLO | ARTICLE

SB321



Short wall mounted spout

Bocca d'erogazione corta a parete

Bec de remplissage mural court

CODICE / COEFFICIENTE | CODE /
COEFFICIENT | CODE / COEFFICIENT

CC	SB321CC	5,1
SS	SB321SS	6,4
NP	SB321NP	6,1
OS	SB321OS	8,2
RS	SB321RS	7,7
ON	SB321ON	5,1

PACKAGING

 L: 210 mm
D: 130 mm
H: 70 mm

0,5 kg

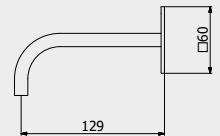

PORTATE | WATER FLOW | DÉBIT D'EAU

1 BAR	2 BAR	3 BAR
10 l/m	11 l/m	12,5 l/m

ARTICLE | ARTICOLO | ARTICLE

SB322



Long wall mounted spout

Bocca d'erogazione lunga a parete

Bec de remplissage mural long

CODICE / COEFFICIENTE | CODE /
COEFFICIENT | CODE / COEFFICIENT

CC	SB322CC	5,1
SS	SB322SS	6,4
NP	SB322NP	6,1
OS	SB322OS	8,2
RS	SB322RS	7,7
ON	SB322ON	5,1

PACKAGING

 L: 210 mm
D: 130 mm
H: 70 mm

0,5 kg



PORTATE | WATER FLOW | DÉBIT D'EAU

1 BAR	2 BAR	3 BAR
10 l/m	11 l/m	12,5 l/m

ARTICLE | ARTICOLO | ARTICLE

SB706



Exposed parts for bidet spray complete with mixer

Set di parti esterne per Idroscopino igienico con miscelatore

Partie extérieure pour douchette hygiénique avec mitigeur

CODICE / COEFFICIENTE | CODE /
COEFFICIENT | CODE / COEFFICIENT

CC	ESB706CC	9,8
SS	ESB706SS	12,3
NP	ESB706NP	11,8
OS	ESB706OS	15,7
RS	ESB706RS	14,7
ON	ESB706ON	9,8

PACKAGING

 L: 370 mm
D: 270 mm
H: 80 mm

3,1 kg

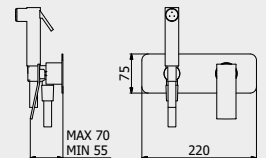

PORTATE | WATER FLOW | DÉBIT D'EAU

1 BAR	2 BAR	3 BAR
10 l/m	14 l/m	17 l/m

Built-in body to be purchased separately

Corpo incasso da acquistare separatamente

Corps intégré à acheter séparément



CODICE | CODE | CODE

INC206XXXN_19

COEFFICIENTE | COEFFICIENT | COEFFICIENT

2,9

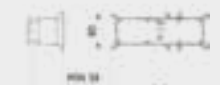

ARTICLE | ARTICOLO | ARTICLE

SB370



Single Lever kitchen mixer

Miscelatore lavello monoforo

Évier de cuisine

CODICE / COEFFICIENTE | CODE /
COEFFICIENT | CODE / COEFFICIENT

CC	SB370CC	12,8
SS	SB370SS	16,0
NP	SB370NP	15,4
OS	SB370OS	20,5
RS	SB370RS	19,2
ON	SB370ON	12,8

PACKAGING

 L: 400 mm
D: 250 mm
H: 140 mm

2,8 kg

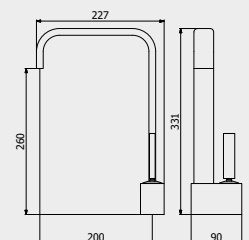

PORTATE | WATER FLOW | DÉBIT D'EAU

1 BAR	2 BAR	3 BAR
10 l/m	14 l/m	17 l/m



SNATCH / ACCESSORIES COLLECTION

ARTICLE | ARTICOLO | ARTICLE

HJ001



Wall soap-holder
Porta sapone a muro
Porte distributeur de savon encastré

CODICE / COEFFICIENTE | CODE / COEFFICIENT

CC	HJ001CC	5,5
SS	HJ001SS	5,7
BO	HJ001BO	5,7
NP	HJ001NP	5,7
CF	HJ001CF	5,7
CS	HJ001CS	5,7
II	HJ001II	5,7
IS	HJ001IS	5,7
RS	HJ001RS	5,7
SR	HJ001SR	5,7
OO	HJ001OO	5,7
OS	HJ001OS	5,7

PACKAGING

	L: 150 mm D: 190 mm H: 98 mm		0,4 kg
--	------------------------------------	--	--------

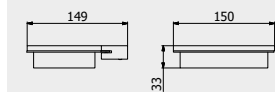

ARTICLE | ARTICOLO | ARTICLE

HJ003



Wall toothbrush holder
Porta spazzolino a muro
Porte brosse à dents encastré

CODICE / COEFFICIENTE | CODE / COEFFICIENT

CC	HJ003CC	6,1
SS	HJ003SS	6,3
BO	HJ003BO	6,3
NP	HJ003NP	6,3
CF	HJ003CF	6,3
CS	HJ003CS	6,3
II	HJ003II	6,3
IS	HJ003IS	6,3
RS	HJ003RS	6,3
SR	HJ003SR	6,3
OO	HJ003OO	6,3
OS	HJ003OS	6,3

PACKAGING

	L: 175 mm D: 125 mm H: 90 mm		0,2 kg
--	------------------------------------	--	--------

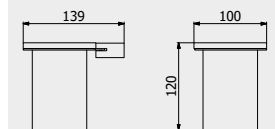

ARTICLE | ARTICOLO | ARTICLE

HJ016



Soap dispenser
Porta sapone da appoggio
Porte distributeur de savon

CODICE / COEFFICIENTE | CODE / COEFFICIENT

CC	HJ016CC	2,2
SS	HJ016SS	2,4
BO	HJ016BO	2,4
NP	HJ016NP	2,4
CF	HJ016CF	2,4
CS	HJ016CS	2,4
II	HJ016II	2,4
IS	HJ016IS	2,4
RS	HJ016RS	2,4
SR	HJ016SR	2,4
OO	HJ016OO	2,4
OS	HJ016OS	2,4

PACKAGING

	L: 150 mm D: 190 mm H: 98 mm		1,1 kg
--	------------------------------------	--	--------

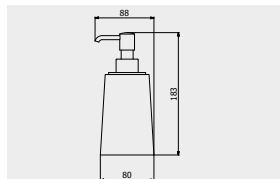

ARTICLE | ARTICOLO | ARTICLE

HJ017



Soap holder
Porta sapone da appoggio
Porte savon

CODE / COEFFICIENT | CODICE / COEFFICIENT

CC	HJ017CC	3,8
----	---------	-----

PACKAGING

	L: 175 mm D: 125 mm H: 90 mm		0,5 kg
--	------------------------------------	--	--------

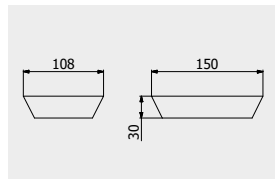

ARTICLE | ARTICOLO | ARTICLE

HJ010

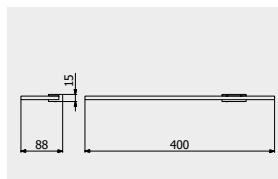

Shelf

Mensola

Etagère

CODICE / COEFFICIENTE | CODE /
COEFFICIENT | CODE / COEFFICIENT

CC	HJ010CC	5,1
SS	HJ010SS	5,3
BO	HJ010BO	5,3
NP	HJ010NP	5,3
CF	HJ010CF	5,3
CS	HJ010CS	5,3
II	HJ010II	5,3
IS	HJ010IS	5,3
RS	HJ010RS	5,3
SR	HJ010SR	5,3
OO	HJ010OO	5,3
OS	HJ010OS	5,3

PACKAGING

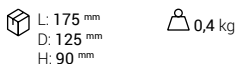

ARTICLE | ARTICOLO | ARTICLE

HJ011

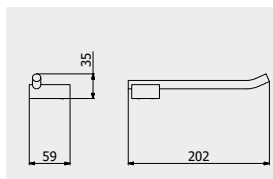

Toilet paper holder

Porta rotolo

Porte rouleaux de toilette

CODICE / COEFFICIENTE | CODE /
COEFFICIENT | CODE / COEFFICIENT

CC	HJ011CC	3,5
SS	HJ011SS	4,4
BO	HJ011BO	4,4
NP	HJ011NP	4,2
CF	HJ011CF	5,3
CS	HJ011CS	5,7
II	HJ011II	5,3
IS	HJ011IS	5,7
RS	HJ011RS	5,3
SR	HJ011SR	5,7
OO	HJ011OO	5,7
OS	HJ011OS	5,3

PACKAGING

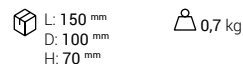

ARTICLE | ARTICOLO | ARTICLE

HJ009

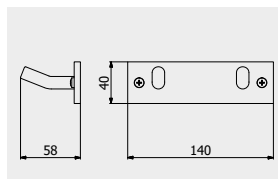

Double robe hook

Doppio appendino a parete

Double cintre

CODICE / COEFFICIENTE | CODE /
COEFFICIENT | CODE / COEFFICIENT

CC	HJ009CC	3,4
SS	HJ009SS	4,3
BO	HJ009BO	4,3
NP	HJ009NP	4,3
CF	HJ009CF	5,1
CS	HJ009CS	5,4
II	HJ009II	5,4
IS	HJ009IS	5,4
RS	HJ009RS	5,1
SR	HJ009SR	5,4
OO	HJ009OO	5,1
OS	HJ009OS	5,4

PACKAGING

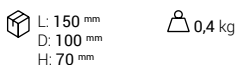

ARTICLE | ARTICOLO | ARTICLE

HJ004

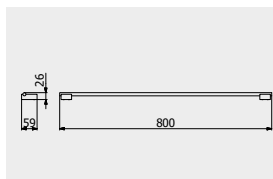

Towel holder

Porta salvietta

Porte-serviette

CODICE / COEFFICIENTE | CODE /
COEFFICIENT | CODE / COEFFICIENT

CC	HJ004CC	7,5
SS	HJ004SS	9,4
BO	HJ004BO	9,4
NP	HJ004NP	9,4
CF	HJ004CF	11,3
CS	HJ004CS	12,0
II	HJ004II	11,3
IS	HJ004IS	12,0
RS	HJ004RS	11,3
SR	HJ004SR	12,0
OO	HJ004OO	11,3
OS	HJ004OS	12,0

PACKAGING

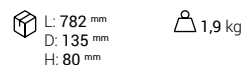

ARTICLE | ARTICOLO | ARTICLE

HJ014

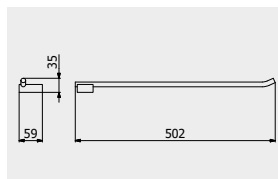

Towel holder

Porta salvietta

Porte-serviette

CODICE / COEFFICIENTE | CODE /
COEFFICIENT | CODE / COEFFICIENT

CC	HJ014CC	5,1
SS	HJ014SS	6,4
BO	HJ014BO	6,4
NP	HJ014NP	6,4
CF	HJ014CF	7,7
CS	HJ014CS	8,2
II	HJ014II	7,7
IS	HJ014IS	8,2
RS	HJ014RS	7,7
SR	HJ014SR	8,2
OO	HJ014OO	7,7
OS	HJ014OS	8,2

PACKAGING

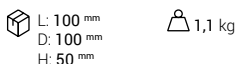

ARTICLE | ARTICOLO | ARTICLE

HJ006

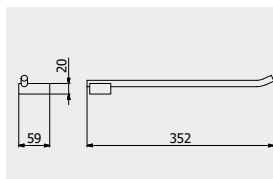

Towel holder

Porta salvietta

Porte-serviette

CODICE / COEFFICIENTE | CODE /
COEFFICIENT | CODE / COEFFICIENT

CC	HJ006CC	4,9
SS	HJ006SS	6,1
BO	HJ006BO	6,1
NP	HJ006NP	6,1
CF	HJ006CF	7,4
CS	HJ006CS	7,8
II	HJ006II	7,4
IS	HJ006IS	7,8
RS	HJ006RS	7,4
SR	HJ006SR	7,8
OO	HJ006OO	7,4
OS	HJ006OS	7,8

PACKAGING

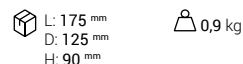

ARTICLE | ARTICOLO | ARTICLE

HJ007

Ring Towel holder

Porta salvietta ad anello

Porte-serviette anneau

CODICE / COEFFICIENTE | CODE / COEFFICIENT

CC	HJ007CC	5,0
SS	HJ007SS	6,3
BO	HJ007BO	6,3
NP	HJ007NP	6,3
CF	HJ007CF	7,5
CS	HJ007CS	8,0
II	HJ007II	7,5
IS	HJ007IS	8,0
RS	HJ007RS	7,5
SR	HJ007SR	8,0
OO	HJ007OO	7,5
OS	HJ007OS	8,0

PACKAGING

L:	340 mm	Weight icon	1,9 kg
D:	180 mm		
H:	70 mm		

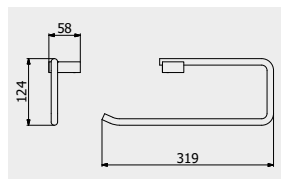

ARTICLE | ARTICOLO | ARTICLE

HJ012

Toilet brush holder

Porta scopino da terra

Porte balayette au sol

CODICE / COEFFICIENTE | CODE / COEFFICIENT

CC	HJ012CC	7,8
SS	HJ012SS	9,8
BO	HJ012BO	9,8
NP	HJ012NP	9,8
CF	HJ012CF	11,7
CS	HJ012CS	12,5
II	HJ012II	11,7
IS	HJ012IS	12,5
RS	HJ012RS	11,7
SR	HJ012SR	12,5
OO	HJ012OO	11,7
OS	HJ012OS	12,5

PACKAGING

L:	100 mm	Weight icon	1,8 kg
D:	100 mm		
H:	50 mm		

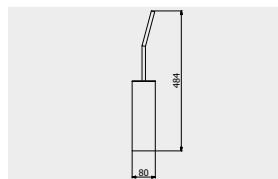

ARTICLE | ARTICOLO | ARTICLE

HJ015

Toothbrush holder

Porta spazzolino

Porte brosse à dents

CODICE / COEFFICIENTE | CODE / COEFFICIENT

CC	HJ015CC	2,8
----	---------	-----

PACKAGING

L:	175 mm	Weight icon	0,6 kg
D:	125 mm		
H:	90 mm		

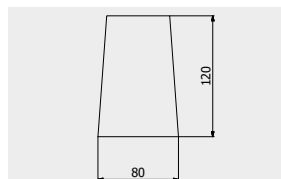

ARTICLE | ARTICOLO | ARTICLE

HJ018

Box

Scatola

Boîte

CODICE / COEFFICIENTE | CODE / COEFFICIENT

CC	HJ018CC	4,1
SS	HJ018SS	4,3
BO	HJ018BO	4,3
NP	HJ018NP	4,3
CF	HJ018CF	4,3
CS	HJ018CS	4,3
II	HJ018II	4,3
IS	HJ018IS	4,3
RS	HJ018RS	4,3
SR	HJ018SR	4,3
OO	HJ018OO	4,3
OS	HJ018OS	4,3

PACKAGING

L:	240 mm	Weight icon	1,2 kg
D:	215 mm		
H:	110 mm		

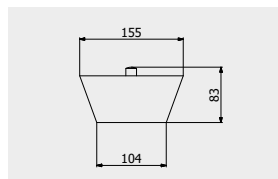

Superbox

MILANOTORINO

Simple and versatile shapes as a trait of strength and identity without equal.

Forme semplici e versatili come tratto di forza e identità senza eguali.
Formes simples et polyédriques un trait de force et d'identité sans égaux.

Two great eclectic cities, two Italian cultural and economical capitals, two original and a little bit crazy souls, joined in the name of a famous cocktail with a strong and uncompromised flavour. From the name of the aperitif with an intense character and flavour, the vigorous and audacious MILANOTORINO collection is born, whose versatility becomes a trait of strength and identity without equal.

Due grandi città eclettiche, due capitali della cultura e dell'economia italiana, due anime originali e un poco pazze, unite nel nome di un famoso cocktail dal sapore forte e senza compromessi. Dal nome dell'aperitivo dal carattere e dal sapore intensi, nasce una collezione vigorosa e audace, che fa della sua poliedricità un tratto di forza e di identità senza eguali.

Deux grandes villes éclectiques, deux capitales de la culture et de l'économie italiennes, deux âmes originales et un peu folles, réunies dans le nom d'un célèbre cocktail à la saveur résolue et sans compromis. Du nom de l'apéritif au caractère et à la saveur intenses est née une collection vigoureuse et audacieuse, qui fait de son essence polyédrique un trait de force et d'identité sans égaux.



KITCHEN
AVAILABLE



CRYSTAL CLEAR
WATER



LEAD FREE



ZINC FREE





Milano
Torino

DESIGN
ANDREA + DAVIDE BREGOLI



- ↑ **MT200CC**
Monohole washbasin mixer
Miscelatore lavabo monoforo
Mitigeur lavabo
- ↙ **MT220CC**
Monohole bidet mixer
Miscelatore bidet monoforo
Mitigeur bidet
- **MT202CC**
Tall monohole washbasin mixer
Miscelatore lavabo monoforo alto
Mitigeur lavabo haut



Milano
Torino



↑ MT200CC
Monohole washbasin mixer
Miscelatore lavabo monoforo
Mitigeur lavabo



Milano
Torino

← MT299CC
Monohole free-standing washbasin mixer
complete with drain
Miscelatore lavabo da terra completo di
scarico automatico
Mitigeur Lavabo Free standing complet avec
bonde automatique

↑ MT202CC
Tall monohole washbasin mixer
Miscelatore lavabo monoforo alto
Mitigeur lavabo haut



- MT201SS
Mini monohole washbasin mixer
Miscelatore lavabo monoforo mini
Mitigeur lavabo mini
- ↙ MT206CC
Wall mounted washbasin mixer
Miscelatore lavabo due fori a parete
Mitigeur lavabo mural



Milano
Torino





← MT299CC
Monohole free-standing washbasin mixer
Miscelatore lavabo da terra
Mitigeur lavabo free standing

↑ MT392CC
Three holes washbasin set with low spout
Lavabo tre fori a bocca bassa
Lavabo trois trous bec bas

→ MT314CC
Three ways wall shower mixer complete with
shower kit
Miscelatore doccia a parete con deviatore tre vie e
doccino integrato
Mitigeur douche mural trois voies avec
inverseur et douchette encastrée



Milano
Torino



- ↑ **MT250CC**
 Wall mounted bath filler complete with hand shower kit
 Bordo vasca esterno a parete completo di kit doccia
 Mitigeur Bain/douche Mural avec douchette encastrée
- ← **MT706CC**
 Exposed parts for bidet spray complete with mixer
 Set di parti esterne per Idroscopino igienico con miscelatore
 Partie extérieure pour douchette hygiénique avec mitigeur
- **MT350CC**
 Wall mounted bath filler complete with hand shower kit
 Bordo vasca esterno a parete completo di kit doccia
 Mitigeur Bain/douche Mural avec douchette encastrée



Milano
Torino

ARTICLE | ARTICOLO | ARTICLE

MT200



Monohole washbasin mixer complete with drain

Miscelatore lavabo monoforo completo di scarico automatico

Mitigeur Lavabo complet avec bonde automatique

CODE / COEFFICIENT | CODICE /
COEFFICIENTE | CODE / COEFFICIENT

CC	MT200CC	6,0
SS	MT200SS	7,5
ON	MT200ON	6,0
BO	MT200BO	7,2
NP	MT200NP	7,2
CF	MT200CF	9,0
CS	MT200CS	9,6
II	MT200II	9,0
IS	MT200IS	9,6
RS	MT200RS	9,0
SR	MT200SR	9,6
OO	MT200OO	9,0
OS	MT200OS	9,6

PACKAGING

 L: 340 mm
D: 180 mm
H: 70 mm

1,6 kg

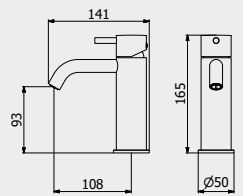

PORTATE | WATER FLOW | DÉBIT D'EAU

1 BAR	2 BAR	3 BAR
6,5 l/m	9 l/m	11 l/m

ARTICLE | ARTICOLO | ARTICLE

MT201



Mini monohole washbasin mixer complete with drain

Miscelatore lavabo monoforo mini completo di scarico automatico

Mitigeur lavabo Mini complet avec bonde automatique

CODE / COEFFICIENT | CODICE /
COEFFICIENTE | CODE / COEFFICIENT

CC	MT201CC	4,9
SS	MT201SS	6,1
ON	MT201ON	4,9
BO	MT201BO	5,9
NP	MT201NP	5,9
CF	MT201CF	7,4
CS	MT201CS	7,8
II	MT201II	7,4
IS	MT201IS	7,8
RS	MT201RS	7,4
SR	MT201SR	7,8
OO	MT201OO	7,4
OS	MT201OS	7,8

PACKAGING

 L: 340 mm
D: 180 mm
H: 70 mm

1,2 kg

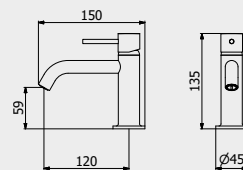

PORTATE | WATER FLOW | DÉBIT D'EAU

1 BAR	2 BAR	3 BAR
4,5 l/m	6,4 l/m	7,5 l/m

ARTICLE | ARTICOLO | ARTICLE

MT202



Tall monohole washbasin mixer complete with drain

Miscelatore lavabo monoforo alto completo di scarico automatico

Mitigeur lavabo Haut complet avec bonde automatique

CODE / COEFFICIENTE | CODE /
COEFFICIENT

CC	MT202CC	9,4
SS	MT202SS	11,8
ON	MT202ON	9,4
BO	MT202BO	11,3
NP	MT202NP	11,3
CF	MT202CF	14,1
CS	MT202CS	15,0
II	MT202II	14,1
IS	MT202IS	15,0
RS	MT202RS	14,1
SR	MT202SR	15,0
OO	MT202OO	14,1
OS	MT202OS	15,0

PACKAGING

 L: 425 mm
D: 188 mm
H: 98 mm

2,3 kg

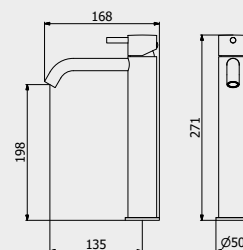

PORTATE | WATER FLOW | DÉBIT D'EAU

1 BAR	2 BAR	3 BAR
6,4 l/m	8,9 l/m	10,9 l/m

ARTICLE | ARTICOLO | ARTICLE

MT203



Tall mini monohole washbasin mixer complete with drain

Miscelatore lavabo monoforo alto mini completo di scarico automatico

Mitigeur Lavabo haut Mini complet avec bonde automatique

CODE / COEFFICIENT | CODICE /
COEFFICIENTE | CODE / COEFFICIENT

CC	MT203CC	6,4
SS	MT203SS	8,0
ON	MT203ON	6,4
BO	MT203BO	7,7
NP	MT203NP	7,7
CF	MT203CF	9,6
CS	MT203CS	10,2
II	MT203II	9,6
IS	MT203IS	10,2
RS	MT203RS	9,6
SR	MT203SR	10,2
OO	MT203OO	9,6
OS	MT203OS	10,2

PACKAGING

 L: 370 mm
D: 270 mm
H: 80 mm

1,8 kg

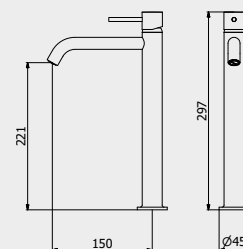

PORTATE | WATER FLOW | DÉBIT D'EAU

1 BAR	2 BAR	3 BAR
4,5 l/m	6,5 l/m	7,8 l/m



ARTICLE | ARTICOLO | ARTICLE

MT206



Wall mounted washbasin mixer complete with drain
Miscelatore lavabo due fori a parete completo di scarico automatico
Mitigeur lavabo mural complet avec bonde automatique

CODE / COEFFICIENT CODICE / COEFFICIENTE CODE / COEFFICIENT	
CC EMT206CC	7,9
SS EMT206SS	9,9
ON EMT206ON	7,9
BO EMT206BO	9,5
NP EMT206NP	9,5
CF EMT206CF	11,9
CS EMT206CS	12,6
II EMT206II	11,9
IS EMT206IS	12,6
RS EMT206RS	11,9
SR EMT206SR	12,6
OO EMT206OO	11,9
OS EMT206OS	12,6

PACKAGING

L: 265 mm
D: 260 mm
H: 70 mm

1,2 kg

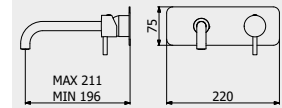

PORTATE | WATER FLOW | DÉBIT D'EAU

1 BAR	2 BAR	3 BAR
7,6 l/m	10,5 l/m	13 l/m

Built-in body to be purchased separately
Corpo incasso da acquistare separatamente
Corps intégré à acheter séparément



CODICE | CODE | CODE

INC206XXXN_19

COEFFICIENTE | COEFFICIENT | COEFFICIENT

2,9



ARTICLE | ARTICOLO | ARTICLE

MT207



Wall mounted washbasin mixer with long spout complete with drain
Miscelatore lavabo due fori a parete con bocca lunga completo di scarico
Mitigeur lavabo mural bec long complet avec bonde automatique

CODE / COEFFICIENT CODICE / COEFFICIENTE CODE / COEFFICIENT	
CC EMT207CC	9,6
SS EMT207SS	12,0
ON EMT207ON	9,6
BO EMT207BO	11,5
NP EMT207NP	11,5
CF EMT207CF	14,4
CS EMT207CS	15,4
II EMT207II	14,4
IS EMT207IS	15,4
RS EMT207RS	14,4
SR EMT207SR	15,4
OO EMT207OO	14,4
OS EMT207OS	15,4

PACKAGING

L: 265 mm
D: 260 mm
H: 70 mm

1,2 kg

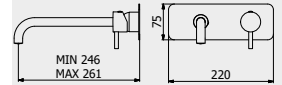

PORTATE | WATER FLOW | DÉBIT D'EAU

1 BAR	2 BAR	3 BAR
7,6 l/m	10,5 l/m	13 l/m

Built-in body to be purchased separately
Corpo incasso da acquistare separatamente
Corps intégré à acheter séparément



CODICE | CODE | CODE

INC206XXXN_19

COEFFICIENTE | COEFFICIENT | COEFFICIENT

2,9

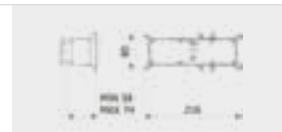

ARTICLE | ARTICOLO | ARTICLE

MT208



Wall mounted washbasin mixer with short spout complete with drain
Miscelatore lavabo due fori a parete con bocca corta completo di scarico
Mitigeur lavabo mural bec court complet avec bonde automatique

CODE / COEFFICIENT CODICE / COEFFICIENTE CODE / COEFFICIENT	
CC EMT208CC	9,6
SS EMT208SS	12,0
ON EMT208ON	9,6
BO EMT208BO	11,5
NP EMT208NP	11,5
CF EMT208CF	14,4
CS EMT208CS	15,4
II EMT208II	14,4
IS EMT208IS	15,4
RS EMT208RS	14,4
SR EMT208SR	15,4
OO EMT208OO	14,4
OS EMT208OS	15,4

PACKAGING

L: 265 mm
D: 260 mm
H: 70 mm

1,2 kg

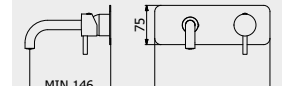

PORTATE | WATER FLOW | DÉBIT D'EAU

1 BAR	2 BAR	3 BAR
7,6 l/m	10,5 l/m	13 l/m

Built-in body to be purchased separately
Corpo incasso da acquistare separatamente
Corps intégré à acheter séparément



CODICE | CODE | CODE

INC206XXXN_19

COEFFICIENTE | COEFFICIENT | COEFFICIENT

2,9



Milano
Torino

ARTICLE | ARTICOLO | ARTICLE

MT210



Ceiling spout with wall mounted mixer

Bocca da soffitto con comando remoto ad incasso

Mitigeur lavabo mural avec bec plafond complet avec bonde automatique

CODICE / COEFFICIENTE	CODE / COEFFICIENT	
● CC	EMT210CC	27,5
● BO	EMT210BO	33,0
● NP	EMT210NP	33,0

PACKAGING

L: 150 mm
D: 190 mm
H: 98 mm

L: 1700 mm
Ø: 70 mm

4,5 kg

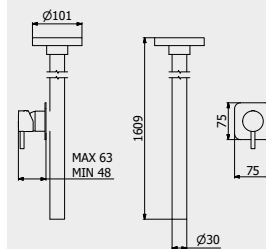
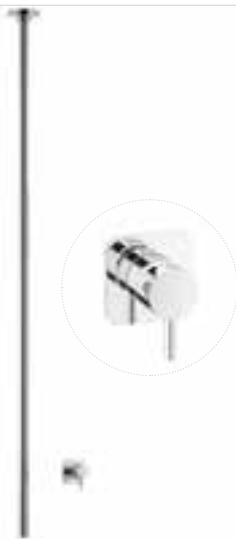

PORTATE | WATER FLOW | DÉBIT D'EAU

1 BAR	2 BAR	3 BAR
4,3 l/m	5,2 l/m	7 l/m

Built-in body to be purchased separately

Corpo incasso da acquistare separatamente

Corps intégré à acheter séparément



CODICE | CODE | CODE

INC300XXXN_19

COEFFICIENTE | COEFFICIENT | COEFFICIENT

1,8



ARTICLE | ARTICOLO | ARTICLE

MT299



Monohole free-standing washbasin mixer complete with drain

Miscelatore lavabo da terra completo di scarico automatico

Mitigeur lavabo free standing complet avec bonde automatique

CODICE / COEFFICIENTE	CODE / COEFFICIENT	
● CC	EMT299CC	27,6
● SS	EMT299SS	34,5
● ON	EMT299ON	27,6
● BO	EMT299BO	33,1
● NP	EMT299NP	33,1
● CF	EMT299CF	41,4
● CS	EMT299CS	44,2
● II	EMT299II	41,4
● IS	EMT299IS	44,2
● RS	EMT299RS	41,4
● SR	EMT299SR	44,2
● OO	EMT299OO	41,4
● OS	EMT299OS	44,2

PACKAGING

L: 1160 mm
D: 360 mm
H: 180 mm

13,8 kg

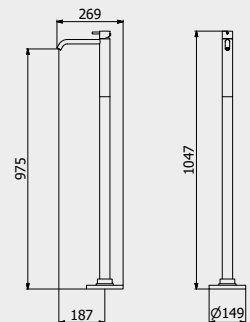

PORTATE | WATER FLOW | DÉBIT D'EAU

1 BAR	2 BAR	3 BAR
5,5 l/m	7,8 l/m	9,6 l/m

Built-in body to be purchased separately
AVAILABLE FROM JANUARY 2020

Corpo incasso da acquistare separatamente
DISPONIBILE DA GENNAIO 2020

Corps intégré à acheter séparément
DISPONIBLE À PARTIR DE JANVIER 2020



CODICE | CODE | CODE

INC399XXXN_19

COEFFICIENTE | COEFFICIENT | COEFFICIENT

2,8

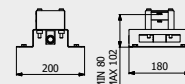

ARTICLE | ARTICOLO | ARTICLE

MT392



Three holes washbasin set with low spout

Lavabo tre fori a bocca bassa completo di scarico automatico

Lavabo trois trous bec bas

CODICE / COEFFICIENTE	CODE / COEFFICIENT	
● CC	MT392CC	11,5
● SS	MT392SS	14,4
● ON	MT392ON	11,5
● BO	MT392BO	13,8
● NP	MT392NP	13,8
● CF	MT392CF	17,3
● CS	MT392CS	18,4
● II	MT392II	17,3
● IS	MT392IS	18,4
● RS	MT392RS	17,3
● SR	MT392SR	18,4
● OO	MT392OO	17,3
● OS	MT392OS	18,4

PACKAGING

L: 370 mm
D: 270 mm
H: 80 mm

4,5 kg

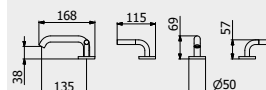

PORTATE | WATER FLOW | DÉBIT D'EAU

1 BAR	2 BAR	3 BAR
6,5 l/m	9 l/m	11 l/m



ARTICLE | ARTICOLO | ARTICLE

MT220



Monohole bidet mixer complete with drain

Miscelatore bidet monoforo completo di scarico automatico

Mitigeur bidet complet avec bonde automatique

CODE / COEFFICIENT	CODICE / COEFFICIENTE	COEFFICIENT
CC	MT220CC	6,0
SS	MT220SS	7,5
ON	MT220ON	6,0
BO	MT220BO	7,2
NP	MT220NP	7,2
CF	MT220CF	9,0
CS	MT220CS	9,6
II	MT220II	9,0
IS	MT220IS	9,6
RS	MT220RS	9,0
SR	MT220SR	9,6
OO	MT220OO	9,0
OS	MT220OS	9,6

PACKAGING

L: 340 mm
D: 180 mm
H: 70 mm

1,6 kg

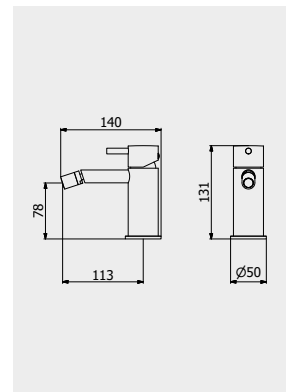

PORTATE | WATER FLOW | DÉBIT D'EAU

1 BAR	2 BAR	3 BAR
6,5 l/m	9 l/m	11 l/m

ARTICLE | ARTICOLO | ARTICLE

MT223



Mini monohole bidet mixer complete with drain

Miscelatore bidet monoforo mini completo di scarico automatico

Mitigeur bidet complet avec bonde automatique

CODE / COEFFICIENT	CODICE / COEFFICIENTE	COEFFICIENT
CC	MT223CC	4,9
SS	MT223SS	6,1
ON	MT223ON	4,9
BO	MT223BO	5,9
NP	MT223NP	5,9
CF	MT223CF	7,4
CS	MT223CS	7,8
II	MT223II	7,4
IS	MT223IS	7,8
RS	MT223RS	7,4
SR	MT223SR	7,8
OO	MT223OO	7,4
OS	MT223OS	7,8

PACKAGING

L: 340 mm
D: 180 mm
H: 70 mm

1,3 kg

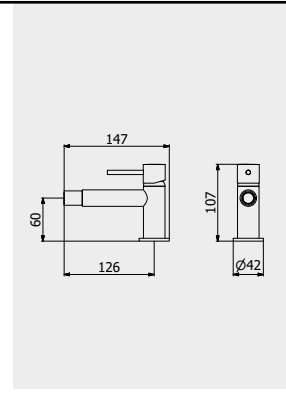

PORTATE | WATER FLOW | DÉBIT D'EAU

1 BAR	2 BAR	3 BAR
4,5 l/m	6,5 l/m	7,5 l/m

Milano Torino

ARTICLE | ARTICOLO | ARTICLE

MT300



Exposed parts for manual wall mixer

Set di parti esterne per miscelatore a parete ad una via

Partie extérieure pour mitigeur encastré à une voie

CODE / COEFFICIENT	CODICE / COEFFICIENTE	COEFFICIENT
CC	EMT300CC	4,1
SS	EMT300SS	5,1
ON	EMT300ON	4,1
BO	EMT300BO	4,9
NP	EMT300NP	4,9
CF	EMT300CF	6,2
CS	EMT300CS	6,6
II	EMT300II	6,2
IS	EMT300IS	6,6
RS	EMT300RS	6,2
SR	EMT300SR	6,6
OO	EMT300OO	6,2
OS	EMT300OS	6,6

PACKAGING

L: 150 mm
D: 190 mm
H: 98 mm

1,2 kg

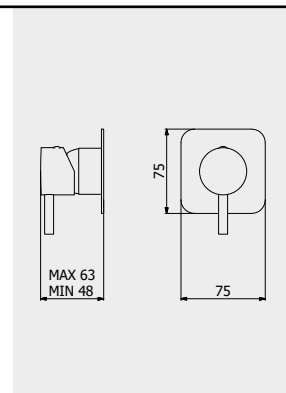

PORTATE | WATER FLOW | DÉBIT D'EAU

1 BAR	2 BAR	3 BAR
11,5 l/m	16,3 l/m	20 l/m

Built-in body to be purchased separately

Corpo incasso da acquistare separatamente

Corps intégré à acheter séparément



CODICE | CODE | CODE

INC300XXXN_19

COEFFICIENTE | COEFFICIENT | COEFFICIENT

1,8



ARTICLE | ARTICOLO | ARTICLE

MT310



Exposed parts for manual wall mixer with two ways diverter
Miscelatore doccia a parete con deviatore due vie
Mitigeur douche mural deux voies avec inverseur

CODE / COEFFICIENTE	CODICE / CODICE	COEFFICIENTE / COEFFICIENTE
CC	EMT310CC	6,1
SS	EMT310SS	7,6
ON	EMT310ON	6,1
BO	EMT310BO	7,3
NP	EMT310NP	7,3
CF	EMT310CF	9,2
CS	EMT310CS	9,8
II	EMT310II	9,2
IS	EMT310IS	9,8
RS	EMT310RS	9,2
SR	EMT310SR	9,8
OO	EMT310OO	9,2
OS	EMT310OS	9,8

PACKAGING

L: 150 mm
D: 190 mm
H: 98 mm

1,2 kg

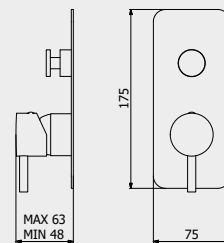

PORTATE | WATER FLOW | DÉBIT D'EAU

1 BAR	2 BAR	3 BAR
9,2 l/m	12,8 l/m	16 l/m

Built-in body to be purchased separately

Corpo incasso da acquistare separatamente

Corps intégré à acheter séparément



CODICE | CODE | CODE

INC310XXXN_19

COEFFICIENTE | COEFFICIENT | COEFFICIENT

3,3

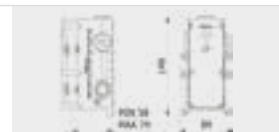

ARTICLE | ARTICOLO | ARTICLE

MT312



Exposed parts for manual wall mixer with three ways diverter
Set di parti esterne per miscelatore a parete a tre vie
Mitigeur douche mural trois voies avec inverseur

CODE / COEFFICIENTE	CODICE / CODICE	COEFFICIENTE / COEFFICIENTE
CC	EMT312CC	7,4
SS	EMT312SS	9,3
ON	EMT312ON	7,4
BO	EMT312BO	8,9
NP	EMT312NP	8,9
CF	EMT312CF	11,1
CS	EMT312CS	11,8
II	EMT312II	11,1
IS	EMT312IS	11,8
RS	EMT312RS	11,1
SR	EMT312SR	11,8
OO	EMT312OO	11,1
OS	EMT312OS	11,8

PACKAGING

L: 150 mm
D: 190 mm
H: 98 mm

1,2 kg

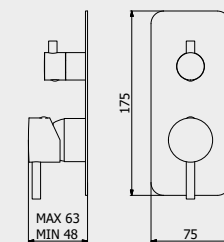

PORTATE | WATER FLOW | DÉBIT D'EAU

1 BAR	2 BAR	3 BAR
8,3 l/m	11,7 l/m	14,3 l/m

Built-in body to be purchased separately

Corpo incasso da acquistare separatamente

Corps intégré à acheter séparément



CODICE | CODE | CODE

INC312XXXN_19

COEFFICIENTE | COEFFICIENT | COEFFICIENT

3,3

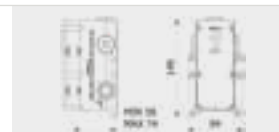

ARTICLE | ARTICOLO | ARTICLE

MT313



Exposed parts for manual wall mixer with 2 ways with shower kit
Set di parti esterne per miscelatore a parete a due vie completo di kit doccia
Partie extérieure pour mitigeur encastré à deux voies avec douchette

CODE / COEFFICIENTE	CODICE / CODICE	COEFFICIENTE / COEFFICIENTE
CC	EMT313CC	10,1
SS	EMT313SS	12,6
ON	EMT313ON	10,1
BO	EMT313BO	12,1
NP	EMT313NP	12,1
CF	EMT313CF	15,2
CS	EMT313CS	16,2
II	EMT313II	15,2
IS	EMT313IS	16,2
RS	EMT313RS	15,2
SR	EMT313SR	16,2
OO	EMT313OO	15,2
OS	EMT313OS	16,2

PACKAGING

L: 370 mm
D: 270 mm
H: 80 mm

1,9 kg

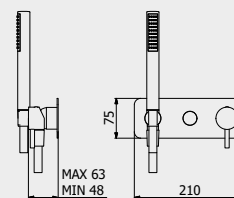

PORTATE | WATER FLOW | DÉBIT D'EAU

1 BAR	2 BAR	3 BAR
10 l/m	14,1 l/m	17,2 l/m

Built-in body to be purchased separately

Corpo incasso da acquistare separatamente

Corps intégré à acheter séparément



CODICE | CODE | CODE

INC313XXXN_19

COEFFICIENTE | COEFFICIENT | COEFFICIENT

3,6



ARTICLE | ARTICOLO | ARTICLE

MT314



Exposed parts for manual wall mixer with 3 ways with shower kit
Set di parti esterne per miscelatore a parete a tre vie completo di kit doccia
Partie extérieure pour mitigeur encastré à trois voies avec douchette

CODE / COEFFICIENT	CODICE / COEFFICIENTE	CODE / COEFFICIENT
CC	EMT314CC	11,4
SS	EMT314SS	14,3
ON	EMT314ON	11,4
BO	EMT314BO	13,7
NP	EMT314NP	13,7
CF	EMT314CF	17,1
CS	EMT314CS	18,2
II	EMT314II	17,1
IS	EMT314IS	18,2
RS	EMT314RS	17,1
SR	EMT314SR	18,2
OO	EMT314OO	17,1
OS	EMT313OS	18,2

PACKAGING

L: 370 mm
D: 270 mm
H: 80 mm

1,9 kg

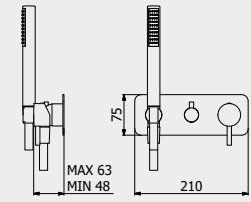

PORTATE | WATER FLOW | DÉBIT D'EAU

1 BAR	2 BAR	3 BAR
8,3 l/m	11,7 l/m	14,3 l/m

Built-in body to be purchased separately

Corpo incasso da acquistare separatamente

Corps intégré à acheter séparément



CODICE | CODE | CODE

INC314XXXN_19

COEFFICIENTE | COEFFICIENT | COEFFICIENT

3,7



ARTICLE | ARTICOLO | ARTICLE

MT610



Two ways wall shower thermostatic valve
Valvola termostatica doccia a parete con deviatore due vie
Valve thermostatique douche mural deux voies avec inverseur

CODE / COEFFICIENT	CODICE / COEFFICIENTE	CODE / COEFFICIENT
CC	EMT610CC	10,4
SS	EMT610SS	13,0
ON	EMT610ON	10,4
BO	EMT610BO	12,5
NP	EMT610NP	12,5
CF	EMT610CF	15,6
CS	EMT610CS	16,6
II	EMT610II	15,6
IS	EMT610IS	16,6
RS	EMT610RS	15,6
SR	EMT610SR	16,6
OO	EMT610OO	15,6
OS	EMT610OS	16,6

PACKAGING

L: 150 mm
D: 190 mm
H: 98 mm

2,4 kg

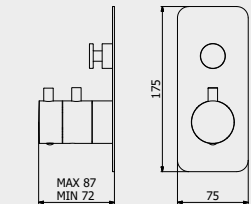

PORTATE | WATER FLOW | DÉBIT D'EAU

1 BAR	2 BAR	3 BAR
11,6 l/m	16,3 l/m	20,1 l/m

Built-in body to be purchased separately

Corpo incasso da acquistare separatamente

Corps intégré à acheter séparément



CODICE | CODE | CODE

INC310XXXN_19

COEFFICIENTE | COEFFICIENT | COEFFICIENT

3,3

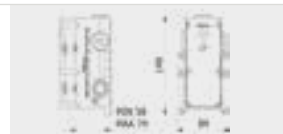

Milano Torino

ARTICLE | ARTICOLO | ARTICLE

MT613



Two ways wall shower thermostatic valve complete with shower kit
Valvola termostatica doccia a parete con deviatore due vie e doccia integrato
Valve thermostatique douche mural deux voies avec inverseur et douchette

CODE / COEFFICIENT	CODICE / COEFFICIENTE	CODE / COEFFICIENT
CC	EMT613CC	14,1
SS	EMT613SS	17,6
ON	EMT613ON	14,1
BO	EMT613BO	16,9
NP	EMT613NP	16,9
CF	EMT613CF	21,1
CS	EMT613CS	22,5
II	EMT613II	21,1
IS	EMT613IS	22,5
RS	EMT613RS	21,1
SR	EMT613SR	22,5
OO	EMT613OO	21,1
OS	EMT613OS	22,5

PACKAGING

L: 150 mm
D: 190 mm
H: 98 mm

2,4 kg

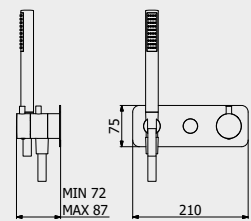

PORTATE | WATER FLOW | DÉBIT D'EAU

1 BAR	2 BAR	3 BAR
11,6 l/m	16,3 l/m	20,1 l/m

Built-in body to be purchased separately

Corpo incasso da acquistare separatamente

Corps intégré à acheter séparément



CODICE | CODE | CODE

INC313XXXN_19

COEFFICIENTE | COEFFICIENT | COEFFICIENT

3,6

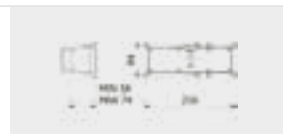

ARTICLE | ARTICOLO | ARTICLE

MT350



Wall mounted shower mixer with shower kit

Doccia esterno a parete completo di kit doccia

Mitigeur de douche externe avec flexible et douchette

CODE / COEFFICIENT | CODICE /
COEFFICIENTE | CODE / COEFFICIENT

● CC	MT350CC	11,7
● SS	MT350SS	14,6
● BO	MT350BO	14,0
● NP	MT350NP	14,0
● CF	MT350CF	17,6
● CS	MT350CS	18,7
● II	MT350II	17,6
● IS	MT350IS	18,7
● RS	MT350RS	17,6
● SR	MT350SR	18,7
● OO	MT350OO	17,6
● OS	MT350OS	18,7

PACKAGING

L: 370 mm
D: 270 mm
H: 80 mm

3,9 kg

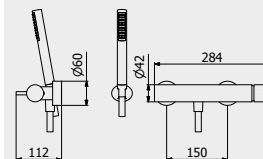

PORTATE | WATER FLOW | DÉBIT D'EAU

1 BAR	2 BAR	3 BAR
12,5 l/m	17,4 l/m	21 l/m

ARTICLE | ARTICOLO | ARTICLE

MT250



Wall mounted bath filler complete with hand shower kit

Bordo vasca esterno a parete completo di kit doccia

Mitigeur Bain/douche mural avec douchette encastrée

CODE / COEFFICIENT | CODICE /
COEFFICIENTE | CODE / COEFFICIENT

● CC	MT250CC	13,1
● SS	MT250SS	16,4
● ON	MT250ON	13,1
● BO	MT250BO	15,7
● NP	MT250NP	15,7
● CF	MT250CF	19,7
● CS	MT250CS	21,0
● II	MT250II	19,7
● IS	MT250IS	21,0
● RS	MT250RS	19,7
● SR	MT250SR	21,0
● OO	MT250OO	19,7
● OS	MT250OS	21,0

PACKAGING

L: 370 mm
D: 270 mm
H: 80 mm

4,2 kg

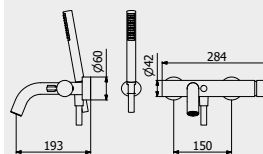

PORTATE | WATER FLOW | DÉBIT D'EAU

1 BAR	2 BAR	3 BAR
10 l/m	14,3 l/m	18 l/m

ARTICLE | ARTICOLO | ARTICLE

MT399



Free-standing bath filler with shower kit

Bordo vasca da terra con kit doccia

Bain douche complet alimentation au sol

CODE / COEFFICIENT | CODICE /
COEFFICIENTE | CODE / COEFFICIENT

● CC	EMT399CC	28,0
● SS	EMT399SS	35,0
● ON	EMT399ON	28,0
● BO	EMT399BO	33,6
● NP	EMT399NP	33,6
● CF	EMT399CF	42,0
● CS	EMT399CS	44,8
● II	EMT399II	42,0
● IS	EMT399IS	44,8
● RS	EMT399RS	42,0
● SR	EMT399SR	44,8
● OO	EMT399OO	42,0
● OS	EMT399OS	44,8

PACKAGING

L: 1100 mm
D: 395 mm
H: 150 mm

15,6 kg

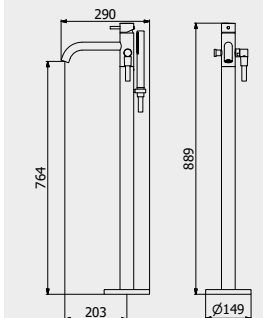

PORTATE | WATER FLOW | DÉBIT D'EAU

1 BAR	2 BAR	3 BAR
11,2 l/m	16 l/m	19,5 l/m

Built-in body to be purchased separately
AVAILABLE FROM JANUARY 2020Corpo incasso da acquistare separatamente
DISPONIBILE DA GENNAIO 2020Corps intégré à acheter séparément
DISPONIBLE À PARTIR DE JANVIER 2020

CODICE | CODE | CODE

INC399XXXN_19

COEFFICIENTE | COEFFICIENT | COEFFICIENT

2,8

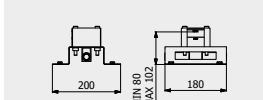

ARTICLE | ARTICOLO | ARTICLE

MT396



Four holes deck mounted bath filler with shower kit
Bordo vasca quattro fori con deviatore e kit doccia
Bain quatre trous avec inverseur et kit douche

CODE / COEFFICIENT	CODICE / COEFFICIENTE	
CC	MT396CC	14,9
SS	MT396SS	18,6
ON	MT396ON	14,9
BO	MT396BO	17,9
NP	MT396NP	17,9
CF	MT396CF	22,4
CS	MT396CS	23,8
II	MT396II	22,4
IS	MT396IS	23,8
RS	MT396RS	22,4
SR	MT396SR	23,8
OO	MT396OO	22,4
OS	MT396OS	23,8

PACKAGING

L: 400 mm
D: 250 mm
H: 140 mm
4,0 kg

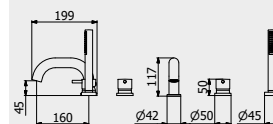

PORTATE	WATER FLOW	DÉBIT D'EAU
1 BAR	2 BAR	3 BAR
9,3 l/m	13,2 l/m	16,2 l/m

ARTICLE | ARTICOLO | ARTICLE

MT397



3 holes bath filler with overflow outlet connection, diverter and shower kit
Bordo vasca 3 fori per colonna riempimento con deviatore e kit doccia
Bain e 3 trous avec inverseur et kit douche pour remplissage ETP

CODE / COEFFICIENT	CODICE / COEFFICIENTE	
CC	MT397CC	11,2
SS	MT397SS	14,0
ON	MT397ON	11,2
BO	MT397BO	13,4
NP	MT397NP	13,4
CF	MT397CF	16,8
CS	MT397CS	17,9
II	MT397II	16,8
IS	MT397IS	17,9
RS	MT397RS	16,8
SR	MT397SR	17,9
OO	MT397OO	16,8
OS	MT397OS	17,9

PACKAGING

L: 370 mm
D: 270 mm
H: 80 mm
3,2 kg

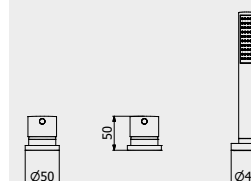

PORTATE	WATER FLOW	DÉBIT D'EAU
1 BAR	2 BAR	3 BAR
12 l/m	17 l/m	22 l/m

Milano
Torino

ARTICLE | ARTICOLO | ARTICLE

RU318



Built-in wall mounted waterfall spout
Cascata a parete con erogazione a lama esterna
Cascade murale avec bec externe

CODE / COEFFICIENT	CODICE / COEFFICIENTE	
CC	RU318CC	22,9
SS	RU318SS	28,6
BO	RU318BO	27,5
NP	RU318NP	27,5
CF	RU318CF	34,4
CS	RU318CS	36,6
II	RU318II	34,4
IS	RU318IS	36,6
RS	RU318RS	34,4
SR	RU318SR	36,6
OO	RU318OO	34,4
OS	RU318OS	36,6

PACKAGING

L: 340 mm
D: 180 mm
H: 70 mm
4,0 kg

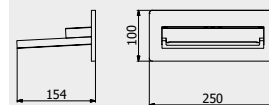

PORTATE	WATER FLOW	DÉBIT D'EAU
1 BAR	2 BAR	3 BAR
13 l/m	17 l/m	20 l/m

ARTICLE | ARTICOLO | ARTICLE

RU319



Wall mounted waterfall

Cascata a parete con erogazione diretta

Cascade murale

CODE / COEFFICIENT | CODICE /
COEFFICIENTE | CODE / COEFFICIENT

● CC	RU319CC	12,8
● SS	RU319SS	16,0
● BO	RU319BO	15,4
● NP	RU319NP	15,4
● CF	RU319CF	19,2
● CS	RU319CS	20,5
● II	RU319II	19,2
● IS	RU319IS	20,5
● RS	RU319RS	19,2
● SR	RU319SR	20,5
● OO	RU319OO	19,2
● OS	RU319OS	20,5

PACKAGING

 L: 340 mm
D: 180 mm
H: 70 mm

3,1 kg

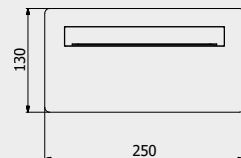

PORTATE | WATER FLOW | DÉBIT D'EAU

1 BAR	2 BAR	3 BAR
13 l/m	17 l/m	20 l/m

ARTICLE | ARTICOLO | ARTICLE

MT320



Wall mounted spout

Bocca d'erogazione a parete

Bec de remplissage mural

CODE / COEFFICIENT | CODICE /
COEFFICIENTE | CODE / COEFFICIENT

● CC	MT320CC	2,1
● SS	MT320SS	2,6
● ON	MT320ON	2,1
● BO	MT320BO	2,5
● NP	MT320NP	2,5
● CF	MT320CF	3,2
● CS	MT320CS	3,4
● II	MT320II	3,2
● IS	MT320IS	3,4
● RS	MT320RS	3,2
● SR	MT320SR	3,4
● OO	MT320OO	3,2
● OS	MT320OS	3,4

PACKAGING

 L: 150 mm
D: 190 mm
H: 98 mm

0,2 kg

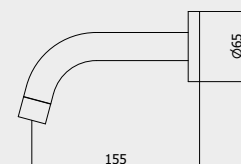

PORTATE | WATER FLOW | DÉBIT D'EAU

1 BAR	2 BAR	3 BAR
10 l/m	14 l/m	17 l/m

ARTICLE | ARTICOLO | ARTICLE

MT321



Short wall mounted spout

Bocca d'erogazione corta a parete

Bec de remplissage mural court

CODE / COEFFICIENT | CODICE /
COEFFICIENTE | CODE / COEFFICIENT

● CC	MT321CC	2,5
● SS	MT321SS	3,1
● ON	MT321ON	2,5
● BO	MT321BO	3,0
● NP	MT321NP	3,0
● CF	MT321CF	3,8
● CS	MT321CS	4,0
● II	MT321II	3,8
● IS	MT321IS	4,0
● RS	MT321RS	3,8
● SR	MT321SR	4,0
● OO	MT321OO	3,8
● OS	MT321OS	4,0

PACKAGING

 L: 150 mm
D: 190 mm
H: 98 mm

0,2 kg

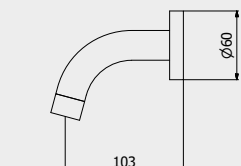

PORTATE | WATER FLOW | DÉBIT D'EAU

1 BAR	2 BAR	3 BAR
10 l/m	14 l/m	17 l/m

ARTICLE | ARTICOLO | ARTICLE

MT322



Long wall mounted spout

Bocca d'erogazione lunga a parete

Bec de remplissage mural long

CODE / COEFFICIENT | CODICE /
COEFFICIENTE | CODE / COEFFICIENT

● CC	MT322CC	2,5
● SS	MT322SS	3,1
● ON	MT322ON	2,5
● BO	MT322BO	3,0
● NP	MT322NP	3,0
● CF	MT322CF	3,8
● CS	MT322CS	4,0
● II	MT322II	3,8
● IS	MT322IS	4,0
● RS	MT322RS	3,8
● SR	MT322SR	4,0
● OO	MT322OO	3,8
● OS	MT322OS	4,0

PACKAGING

 L: 150 mm
D: 190 mm
H: 98 mm

0,2 kg



PORTATE | WATER FLOW | DÉBIT D'EAU

1 BAR	2 BAR	3 BAR
10 l/m	14 l/m	17 l/m



ARTICLE | ARTICOLO | ARTICLE

MT801



Milano Torino thermostatic shower column with shower kit
Colonna doccia Milano Torino termostatica con kit doccia
Milano Torino colonne de douche thermostatique avec kit douche

CODE / COEFFICIENT	CODICE / COEFFICIENTE	COEFFICIENT
CC	MT801CC	25,1
SS	MT801SS	31,4
BO	MT801BO	30,1
NP	MT801NP	30,1

PACKAGING

L: 1020 mm
D: 490 mm
H: 120 mm
3,4 kg

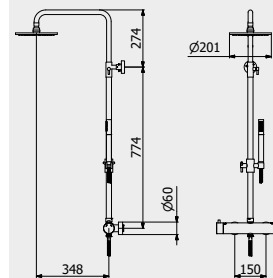

PORTATE | WATER FLOW | DÉBIT D'EAU

1 BAR	2 BAR	3 BAR
11,2 l/m	17 l/m	21,2 l/m

ARTICLE | ARTICOLO | ARTICLE

MT706



Exposed parts for bidet spray complete with mixer
Set di parti esterne per Idroscopino igienico con miscelatore
Partie extérieure pour douchette hygiénique avec mitigeur

CODE / COEFFICIENT	CODICE / COEFFICIENTE	COEFFICIENT
CC	EMT706CC	9,8
SS	EMT706SS	12,3
ON	EMT706ON	9,8
BO	EMT706BO	11,8
NP	EMT706NP	11,8
CF	EMT706CF	14,7
CS	EMT706CS	15,7
II	EMT706II	14,7
IS	EMT706IS	15,7
RS	EMT706RS	14,7
SR	EMT706SR	15,7
OO	EMT706OO	14,7
OS	EMT706OS	15,7

PACKAGING

L: 370 mm
D: 270 mm
H: 80 mm
3,1 kg

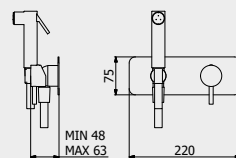

PORTATE | WATER FLOW | DÉBIT D'EAU

1 BAR	2 BAR	3 BAR
2,3 l/m	3,2 l/m	12,5 l/m

Milano Torino

Built-in body to be purchased separately

Corpo incasso da acquistare separatamente

Corps intégré à acheter séparément



CODICE | CODE | CODE

INC206XXXN_19

COEFFICIENTE | COEFFICIENT | COEFFICIENT

2,9

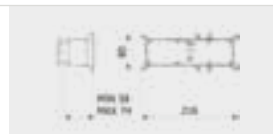

ARTICLE | ARTICOLO | ARTICLE

MT370



Single Lever kitchen mixer
Miscelatore lavello monoforo
Évier de cuisine

CODE / COEFFICIENT	CODICE / COEFFICIENTE	COEFFICIENT
CC	MT370CC	9,6
SS	MT370SS	12,0
ON	MT370ON	9,6
BO	MT370BO	11,5
NP	MT370NP	11,5
CF	MT370CF	14,4
CS	MT370CS	15,4
II	MT370II	14,4
IS	MT370IS	15,4
RS	MT370RS	14,4
SR	MT370SR	15,4
OO	MT370OO	14,4
OS	MT370OS	15,4

PACKAGING

L: 455 mm
D: 310 mm
H: 75 mm
2,6 kg

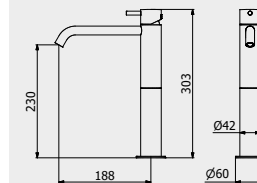

PORTATE | WATER FLOW | DÉBIT D'EAU

1 BAR	2 BAR	3 BAR
6,3 l/m	89 l/m	10,9 l/m

MODERNA / ACCESSORIES COLLECTION

ARTICLE | ARTICOLO | ARTICLE

MO001

Wall soap-holder

Porta sapone a muro

Porte distributeur de savon encastré

CODE / COEFFICIENT | CODICE /
COEFFICIENTE | CODE / COEFFICIENT

CC MO001CC 1,5

PACKAGING

L: 110 mm
 D: 130 mm
 H: 50 mm
 0,4 kg

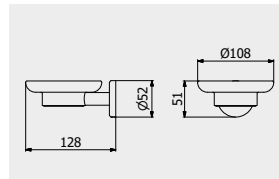

ARTICLE | ARTICOLO | ARTICLE

MO002

Wall soap dispenser holder

Porta dispenser sapone liquido a parete

Porte distributeur de savon en verre gravé

CODE / COEFFICIENT | CODICE /
COEFFICIENTE | CODE / COEFFICIENT

CC MO002CC 2,3

PACKAGING

L: 80 mm
 D: 130 mm
 H: 180 mm
 0,1 kg

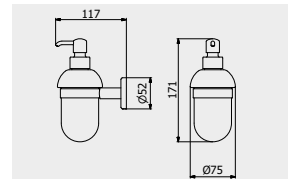

ARTICLE | ARTICOLO | ARTICLE

MO003

Wall toothbrush holder

Bicchieri porta spazzolino a parete

Porte-verre en verre gravé

CODE / COEFFICIENT | CODICE /
COEFFICIENTE | CODE / COEFFICIENT

CC MO003CC 1,5

PACKAGING

L: 70 mm
 D: 110 mm
 H: 100 mm
 0,4 kg

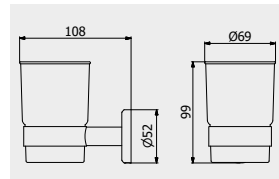

ARTICLE | ARTICOLO | ARTICLE

MO004

Towel holder

Porta salvietta

Porte-serviette

CODE / COEFFICIENT | CODICE /
COEFFICIENTE | CODE / COEFFICIENT

CC MO004CC 2,4

PACKAGING

L: 650 mm
 D: 70 mm
 H: 50 mm
 0,5 kg

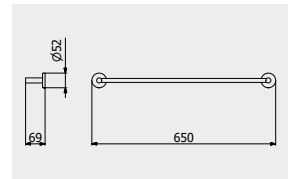

ARTICLE | ARTICOLO | ARTICLE

MO014

Towel holder

Porta salvietta

Porte-serviette

CODE / COEFFICIENT | CODICE /
COEFFICIENTE | CODE / COEFFICIENT

CC MO014CC 2,2

PACKAGING

L: 500 mm
 D: 70 mm
 H: 50 mm
 0,5 kg

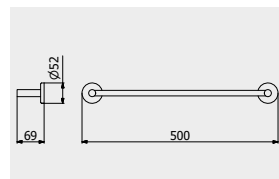

ARTICLE | ARTICOLO | ARTICLE

MO006

Towel holder

Porta salvietta

Porte-serviette

CODE / COEFFICIENT | CODICE /
COEFFICIENTE | CODE / COEFFICIENT

CC MO006CC 2,1

PACKAGING

L: 350 mm
 D: 70 mm
 H: 50 mm
 0,4 kg

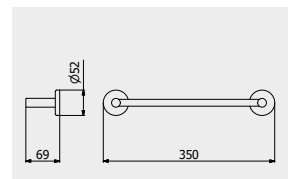

ARTICLE | ARTICOLO | ARTICLE

MO007

Ring Towel holder

Porta salvietta ad anello

Porte-serviettes anneau

CODE / COEFFICIENT | CODICE /
COEFFICIENTE | CODE / COEFFICIENT

CC MO007CC 1,6

PACKAGING

L: 180 mm
D: 70 mm
H: 200 mm

0,8 kg

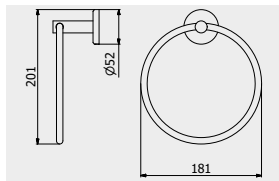

ARTICLE | ARTICOLO | ARTICLE

MO008

Robe Hook

Appendino a parete

Cintre

CODE / COEFFICIENT | CODICE /
COEFFICIENTE | CODE / COEFFICIENT

CC MO008CC 0,9

PACKAGING

L: 50 mm
D: 50 mm
H: 50 mm

0,3 kg

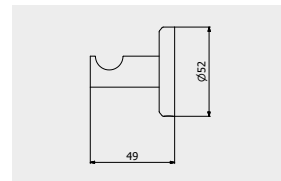

ARTICLE | ARTICOLO | ARTICLE

MO009

Double robe hook

Doppio appendino a parete

Double cintre

CODE / COEFFICIENT | CODICE /
COEFFICIENTE | CODE / COEFFICIENT

CC MO009CC 1,4

PACKAGING

L: 70 mm
D: 70 mm
H: 50 mm

0,1 kg

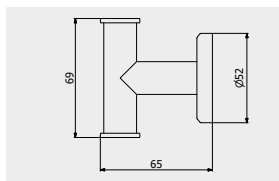

ARTICLE | ARTICOLO | ARTICLE

MO010

Shelf

Mensola

Etagère

CODE / COEFFICIENT | CODICE /
COEFFICIENTE | CODE / COEFFICIENT

CC MO010CC 3,0

PACKAGING

L: 600 mm
D: 140 mm
H: 50 mm

0,3 kg

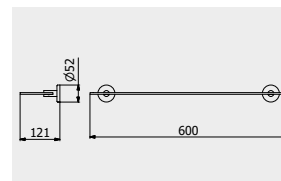

ARTICLE | ARTICOLO | ARTICLE

MO005

Swiveable towel holder

Porta salvietta doppio

Porte-serviettes noeud

CODE / COEFFICIENT | CODICE /
COEFFICIENTE | CODE / COEFFICIENT

CC MO005CC 3,5

PACKAGING

L: 430 mm
D: 70 mm
H: 50 mm

0,5 kg

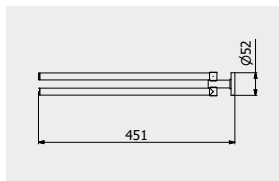

ARTICLE | ARTICOLO | ARTICLE

MO011

Toilet paper holder

Porta rotolo

Porte rouleaux de toilette

CODE / COEFFICIENT | CODICE /
COEFFICIENTE | CODE / COEFFICIENT

CC MO011CC 1,4

PACKAGING

L: 150 mm
D: 70 mm
H: 50 mm

0,2 kg

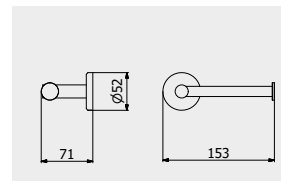

ARTICLE | ARTICOLO | ARTICLE

MO012

Toilet brush holder

Porta scopino da terra

Porte balayette au sol

CODE / COEFFICIENT | CODICE /
COEFFICIENTE | CODE / COEFFICIENT

CC MO012CC 2,5

PACKAGING

L: 80 mm
D: 80 mm
H: 380 mm

0,7 kg

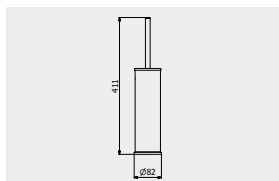

ARTICLE | ARTICOLO | ARTICLE

MO013

Wall toilet brush holder

Porta scopino da parete

Porte balayette

CODE / COEFFICIENT | CODICE /
COEFFICIENTE | CODE / COEFFICIENT

CC MO013CC 2,9

PACKAGING

L: 80 mm
D: 80 mm
H: 380 mm

0,7 kg

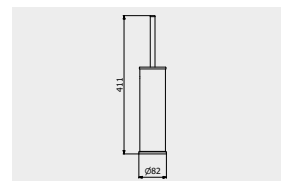

BATLÒ

The reference is the archetype, the shape of the bottle.

Il riferimento è l'archetipo, la forma della bottiglia.

Le point de repère est l'archétype, la forme d'une bouteille.

The collection is inspired by the traditional form of the most iconic and sinuous liquid container, a bottle of water. The lever control, corresponding to the narrow neck of the bottle, allows a soft and vertical closing and opening of the water flow. The fluidity and the intuitive identity of the form is applied to the entire collection, which ranges from the ceiling washbasin mixer to the free-standing bath filler.

La serie è ispirata alla tradizionale forma di una bottiglia d'acqua, contenitore di liquidi sinuoso e iconico. Il comando di erogazione, corrispondente al restringimento del collo della bottiglia, permette un movimento di chiusura e apertura del flusso d'acqua morbido e verticale. La fluidità e l'intuitiva riconoscibilità della forma si estendono alla ricca collezione, che spazia dal lavabo mixer e a soffitto, fino al bordo vasca free-standing.

La collection s'inspire de la forme traditionnelle d'une bouteille d'eau, récipient de liquide sinuose et emblématique. La poignée de commande, correspondant au resserrement du col de la bouteille, permet un mouvement de fermeture et d'ouverture de l'eau doux et vertical. La fluidité et la notoriété intuitive de la forme concernent à l'entière riche collection, qui va du lavabo mixer à plafond jusqu'au bord free-standing de la baignoire.



KITCHEN
AVAILABLE



CRYSTAL CLEAR
WATER



LEAD FREE



ZINC FREE





Batlo

DESIGN
GIULIO IACCHETTI

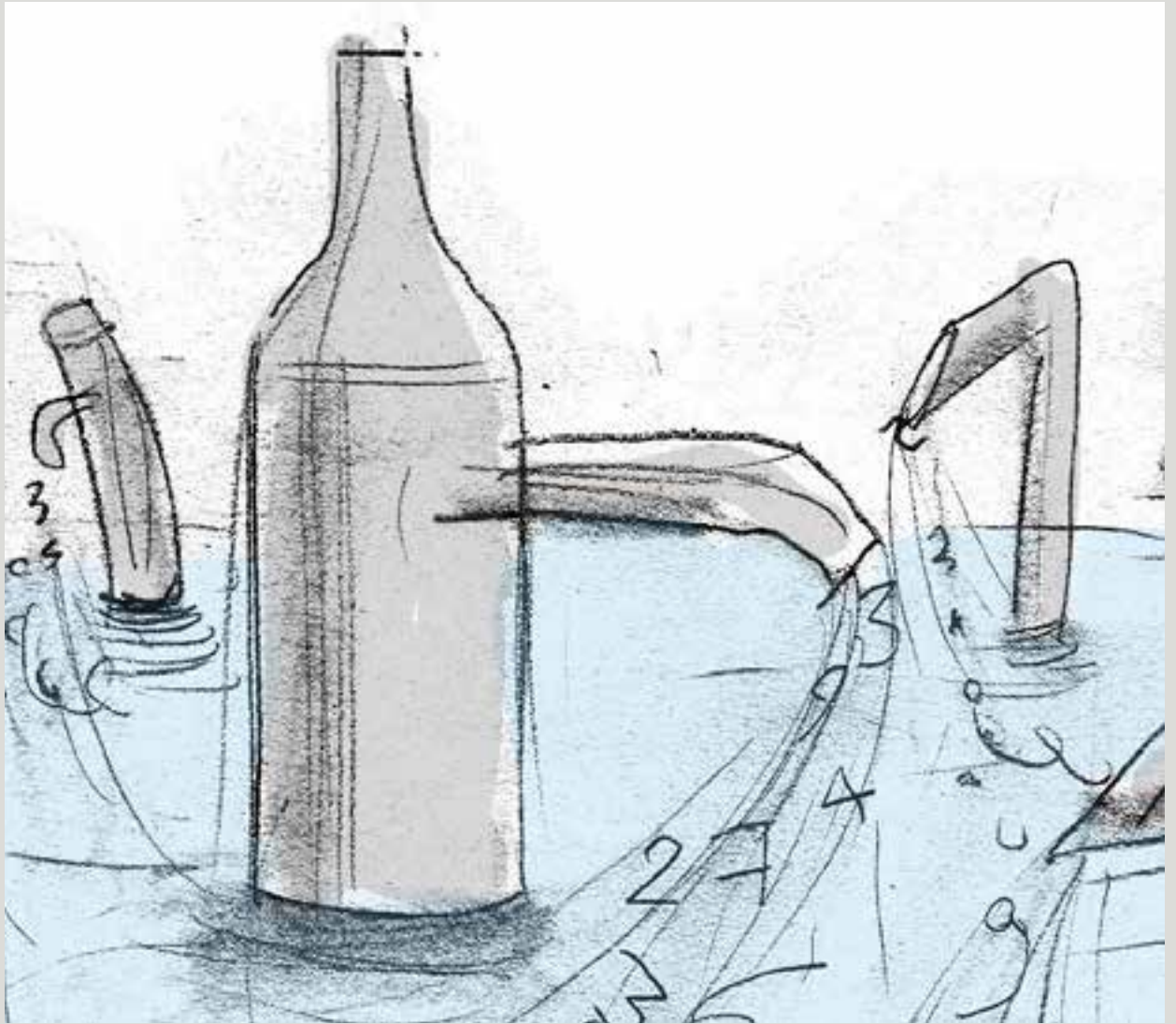

I like the idea that, only by watching the objects I designed, it's easy to connect them to the function they are appointed to perform.

Mi piace l'idea che guardando gli oggetti che disegno sia semplice ricondurli alla funzione che sono chiamati a compiere.

J'aime l'idée qu'il soit facile, juste en regardant les objets que j'ai conçus, de les ramener à la fonction qu'ils sont appelés à exécuter.

“ Having to design a new faucet, I was inspired by the form of a bottle, the container for liquids par excellence ... for the handles I designed some inverted goblets and the shower is an umbrella handle!... It's still water, isn't it?!

Dovendo progettare un nuovo rubinetto ho pensato alla bottiglia, contenitore per eccellenza di liquidi... per le manopole ho disegnato dei calici rovesciati e la doccia è il manico di un ombrello!... sempre di acqua si tratta no?!

Devant concevoir un nouveau robinet, j'ai pensé à une bouteille, le récipient de liquides par excellence... pour ce qui concerne les manettes, j'ai conçu des verres renversés et la douche est le manche d'un parapluie!... il s'agit quand même d'eau, n'est-ce pas?!

”

Giulio Iacchetti design for BATLÓ



↑ BI200CC
Monohole washbasin mixer
Miscelatore lavabo monoforo
Mitigeur lavabo

→ BI202CC
Tall monohole washbasin mixer
Miscelatore lavabo monoforo alto
Mitigeur lavabo haut



Batlo





Batlo

← BI200CC
Monohole washbasin mixer
Miscelatore lavabo monoforo
Mitigeur lavabo

↗ BI220CC
Monohole bidet mixer
Miscelatore bidet monoforo
Mitigeur bidet



↑ BI206CC
Wall mounted washbasin mixer
Miscelatore lavabo due fori a parete
Mitigeur lavabo mural

→ BI392CC
Three holes washbasin set with low spout
Lavabo tre fori a bocca bassa
Lavabo trois trous bec bas



Batlo



↶ **BI300CC**
One way wall shower mixer
Miscelatore doccia a parete una via
Mitigeur douche mural une voie

→ **BI250CC**
Wall mounted bath filler complete with hand shower kit
Bordo vasca esterno a parete completo di kit doccia
Mitigeur Bain/douche Mural avec douchette encastrée





ARTICLE | ARTICOLO | ARTICLE

BI200



Monohole washbasin mixer complete with drain

Miscelatore lavabo monoforo completo di scarico automatico

Mitigeur Lavabo complet avec bonde automatique

CODE / COEFFICIENT | CODICE /
COEFFICIENTE | CODE / COEFFICIENT

●	CC	BI200CC	7,5
●	SS	BI200SS	9,4
●	BO	BI200BO	9,0
●	NP	BI200NP	9,0
●	CF	BI200CF	11,3
●	CS	BI200CS	12,0
●	II	BI200II	11,3
●	IS	BI200IS	12,0
●	RS	BI200RS	11,3
●	SR	BI200SR	12,0
●	OO	BI200OO	11,3
●	OS	BI200OS	12,0

PACKAGING

L: 340 mm
 D: 180 mm
 H: 70 mm

1,9 kg

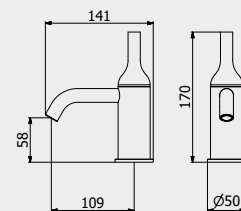

PORTATE | WATER FLOW | DÉBIT D'EAU

1 BAR	2 BAR	3 BAR
6,3 l/m	9 l/m	11 l/m

ARTICLE | ARTICOLO | ARTICLE

BI204



Mid-size monohole washbasin mixer complete with drain

Miscelatore lavabo monoforo medio completo di scarico automatico

Mitigeur Lavabo Moyen complet avec bonde automatique

CODE / COEFFICIENT | CODICE /
COEFFICIENTE | CODE / COEFFICIENT

●	CC	BI204CC	7,7
●	SS	BI204SS	9,6
●	BO	BI204BO	9,2
●	NP	BI204NP	9,2
●	CF	BI204CF	11,6
●	CS	BI204CS	12,3
●	II	BI204II	11,6
●	IS	BI204IS	12,3
●	RS	BI204RS	11,6
●	SR	BI204SR	12,3
●	OO	BI204OO	11,6
●	OS	BI204OS	12,3

PACKAGING

L: 340 mm
 D: 180 mm
 H: 70 mm

1,7 kg

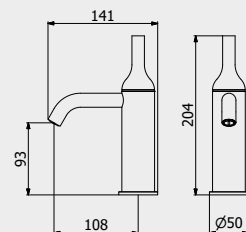

PORTATE | WATER FLOW | DÉBIT D'EAU

1 BAR	2 BAR	3 BAR
6,3 l/m	9 l/m	11 l/m

ARTICLE | ARTICOLO | ARTICLE

BI202



Tall monohole washbasin mixer complete with drain

Miscelatore lavabo monoforo alto completo di scarico automatico

Mitigeur lavabo Haut complet avec bonde automatique

CODE / COEFFICIENT | CODICE /
COEFFICIENTE | CODE / COEFFICIENT

●	CC	BI202CC	10,4
●	SS	BI202SS	13,0
●	BO	BI202BO	12,5
●	NP	BI202NP	12,5
●	CF	BI202CF	15,6
●	CS	BI202CS	16,6
●	II	BI202II	15,6
●	IS	BI202IS	16,6
●	RS	BI202RS	15,6
●	SR	BI202SR	16,6
●	OO	BI202OO	15,6
●	OS	BI202OS	16,6

PACKAGING

L: 425 mm
 D: 188 mm
 H: 98 mm

2,8 kg

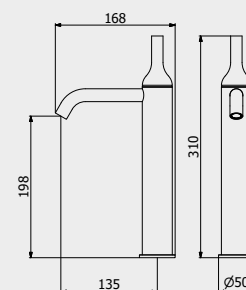

PORTATE | WATER FLOW | DÉBIT D'EAU

1 BAR	2 BAR	3 BAR
6,3 l/m	9 l/m	11 l/m



ARTICLE | ARTICOLO | ARTICLE

BI206



Wall mounted washbasin mixer complete with drain
Miscelatore lavabo due fori a parete completo di scarico automatico
Mitigeur lavabo mural complet avec bonde automatique

CODE / COEFFICIENT CODICE / COEFFICIENTE	COEFFICIENT CODE / COEFFICIENT
CC	EBI206CC 8,8
SS	EBI206SS 11,0
BO	EBI206BO 10,6
NP	EBI206NP 10,6
CF	EBI206CF 13,2
CS	EBI206CS 14,1
II	EBI206II 13,2
IS	EBI206IS 14,1
RS	EBI206RS 13,2
SR	EBI206SR 14,1
OO	EBI206OO 13,2
OS	EBI206OS 14,1

PACKAGING

L: 265 mm
D: 260 mm
H: 70 mm
1,2 kg

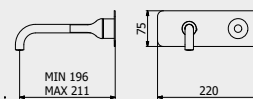

PORTATE | WATER FLOW | DÉBIT D'EAU

1 BAR	2 BAR	3 BAR
7,6 l/m	10,5 l/m	13 l/m

Built-in body to be purchased separately

Corpo incasso da acquistare separatamente

Corps intégré à acheter séparément



CODICE | CODE | CODE

INC206XXXN_19

COEFFICIENTE | COEFFICIENT | COEFFICIENT

2,9



ARTICLE | ARTICOLO | ARTICLE

BI207



Wall mounted washbasin mixer with long spout complete with drain
Miscelatore lavabo 2 fori a parete con bocca lunga completo di scarico
Mitigeur lavabo mural bec long complet avec bonde automatique

CODE / COEFFICIENT CODICE / COEFFICIENTE	COEFFICIENT CODE / COEFFICIENT
CC	EBI207CC 9,6
SS	EBI207SS 12,0
ON	EBI207ON 9,6
BO	EBI207BO 11,5
NP	EBI207NP 11,5
CF	EBI207CF 14,4
CS	EBI207CS 15,4
II	EBI207II 14,4
IS	EBI207IS 15,4
RS	EBI207RS 14,4
SR	EBI207SR 15,4
OO	EBI207OO 14,4
OS	EBI207OS 15,4

PACKAGING

L: 265 mm
D: 260 mm
H: 70 mm
1,2 kg

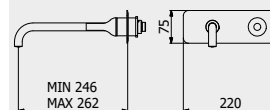

PORTATE | WATER FLOW | DÉBIT D'EAU

1 BAR	2 BAR	3 BAR
7,6 l/m	10,5 l/m	13 l/m

Built-in body to be purchased separately

Corpo incasso da acquistare separatamente

Corps intégré à acheter séparément



CODICE | CODE | CODE

INC206XXXN_19

COEFFICIENTE | COEFFICIENT | COEFFICIENT

2,9



ARTICLE | ARTICOLO | ARTICLE

BI208



Wall mounted washbasin mixer with short spout complete with drain
Miscelatore lavabo 2 fori a parete con bocca corta completo di scarico
Mitigeur lavabo mural bec court complet avec bonde automatique

CODE / COEFFICIENT CODICE / COEFFICIENTE	COEFFICIENT CODE / COEFFICIENT
CC	EBI208CC 9,6
SS	EBI208SS 12,0
ON	EBI208ON 9,6
BO	EBI208BO 11,5
NP	EBI208NP 11,5
CF	EBI208CF 14,4
CS	EBI208CS 15,4
II	EBI208II 14,4
IS	EBI208IS 15,4
RS	EBI208RS 14,4
SR	EBI208SR 15,4
OO	EBI208OO 14,4
OS	EBI208OS 15,4

PACKAGING

L: 265 mm
D: 260 mm
H: 70 mm
1,2 kg

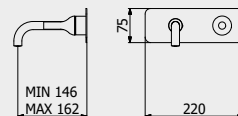

PORTATE | WATER FLOW | DÉBIT D'EAU

1 BAR	2 BAR	3 BAR
7,6 l/m	10,5 l/m	13 l/m

Built-in body to be purchased separately

Corpo incasso da acquistare separatamente

Corps intégré à acheter séparément



CODICE | CODE | CODE

INC206XXXN_19

COEFFICIENTE | COEFFICIENT | COEFFICIENT

2,9



ARTICLE | ARTICOLO | ARTICLE

BI210

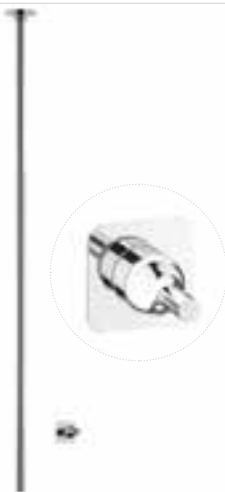

Ceiling spout with wall mounted mixer

Bocca da soffitto con comando remoto ad incasso

Mitigeur lavabo mural avec bec plafond complet avec bonde automatique

CODE / COEFFICIENT	CODICE / COEFFICIENTE	CODE / COEFFICIENT
● CC	EBI210CC	27,5
● SS	EBI210SS	34,4
● BO	EBI210BO	33,0
● NP	EBI210NP	33,0

PACKAGING

L: 150 mm
D: 190 mm
H: 98 mm

L: 1700 mm
Ø: 70 mm

4,5 kg

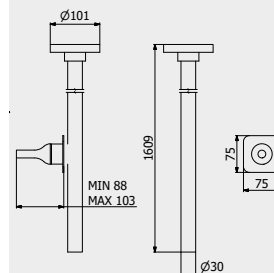

PORTATE | WATER FLOW | DÉBIT D'EAU

1 BAR	2 BAR	3 BAR
4,3 l/m	5,2 l/m	7 l/m

Built-in body to be purchased separately

Corpo incasso da acquistare separatamente

Corps intégré à acheter séparément



CODICE | CODE | CODE

INC300XXXN_19

COEFFICIENTE | COEFFICIENT | COEFFICIENT

1,8

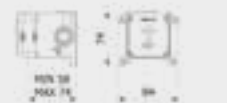

ARTICLE | ARTICOLO | ARTICLE

BI299



Monohole free-standing washbasin mixer complete with drain

Miscelatore lavabo da terra completo di scarico automatico

Mitigeur lavabo free standing complet avec bonde automatique

CODE / COEFFICIENT	CODICE / COEFFICIENTE	CODE / COEFFICIENT
● CC	EBI299CC	29,7
● SS	EBI299SS	37,1
● BO	EBI299BO	35,6
● NP	EBI299NP	35,6
● CF	EBI299CF	44,6
● CS	EBI299CS	47,5
● II	EBI299II	44,6
● IS	EBI299IS	47,5
● RS	EBI299RS	44,6
● SR	EBI299SR	47,5
● OO	EBI299OO	44,6
● OS	EBI299OS	47,5

PACKAGING

L: 1160 mm
D: 360 mm
H: 180 mm

13,8 kg

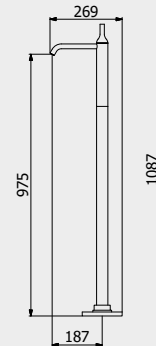

PORTATE | WATER FLOW | DÉBIT D'EAU

1 BAR	2 BAR	3 BAR
13 l/m	16 l/m	19 l/m

Built-in body to be purchased separately
AVAILABLE FROM JANUARY 2020

Corpo incasso da acquistare separatamente
DISPONIBILE DA GENNAIO 2020

Corps intégré à acheter séparément
DISPONIBLE À PARTIR DE JANVIER 2020



CODICE | CODE | CODE

INC399XXXN_19

COEFFICIENTE | COEFFICIENT | COEFFICIENT

2,8

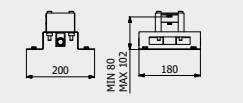

ARTICLE | ARTICOLO | ARTICLE

BI392



Three holes washbasin set with low spout

Lavabo tre fori a bocca bassa completo di scarico automatico

Lavabo trois trous bec bas

CODE / COEFFICIENT	CODICE / COEFFICIENTE	CODE / COEFFICIENT
● CC	BI392CC	12,1
● SS	BI392SS	15,1
● BO	BI392BO	14,5
● NP	BI392NP	14,5
● CF	BI392CF	18,2
● CS	BI392CS	19,4
● II	BI392II	18,2
● IS	BI392IS	19,4
● RS	BI392RS	18,2
● SR	BI392SR	19,4
● OO	BI392OO	18,2
● OS	BI392OS	19,4

PACKAGING

L: 370 mm
D: 270 mm
H: 80 mm

3 kg

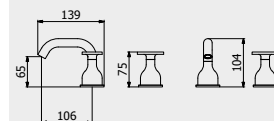

PORTATE | WATER FLOW | DÉBIT D'EAU

1 BAR	2 BAR	3 BAR
6,3 l/m	8,9 l/m	11 l/m



ARTICLE | ARTICOLO | ARTICLE

BI220



Monohole bidet mixer complete with drain

Miscelatore bidet monoforo completo di scarico automatico

Mitigeur bidet complet avec bonde automatique

CODE / COEFFICIENT	CODICE / COEFFICIENTE	COEFFICIENT
CC	BI220CC	7,5
SS	BI220SS	9,4
BO	BI220BO	9,0
NP	BI220NP	9,0
CF	BI220CF	11,3
CS	BI220CS	12,0
II	BI220II	11,3
IS	BI220IS	12,0
RS	BI220RS	11,3
SR	BI220SR	12,0
OO	BI220OO	11,3
OS	BI220OS	12,0

PACKAGING

L: 340 mm
D: 180 mm
H: 70 mm
1,7 kg

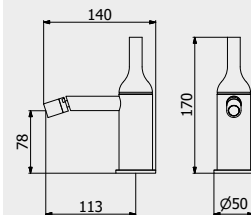

PORTATE | WATER FLOW | DÉBIT D'EAU

1 BAR	2 BAR	3 BAR
6,3 l/m	8,5 l/m	11 l/m

ARTICLE | ARTICOLO | ARTICLE

BI300



Exposed parts for manual wall mixer

Set di parti esterne per miscelatore a parete ad una via

Partie extérieure pour mitigeur encastré à une voie

CODE / COEFFICIENT	CODICE / COEFFICIENTE	COEFFICIENT
CC	EBI300CC	4,1
SS	EBI300SS	5,1
BO	EBI300BO	4,9
NP	EBI300NP	4,9
CF	EBI300CF	6,2
CS	EBI300CS	6,6
II	EBI300II	6,2
IS	EBI300IS	6,6
RS	EBI300RS	6,2
SR	EBI300SR	6,6
OO	EBI300OO	6,2
OS	EBI300OS	6,6

PACKAGING

L: 150 mm
D: 190 mm
H: 98 mm
1,2 kg

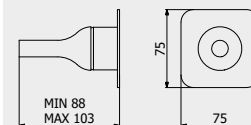

PORTATE | WATER FLOW | DÉBIT D'EAU

1 BAR	2 BAR	3 BAR
13,5 l/m	19 l/m	23,3 l/m

Batìò

Built-in body to be purchased separately

Corpo incasso da acquistare separatamente

Corps intégré à acheter séparément



CODICE | CODE | CODE

INC300XXXN_19

COEFFICIENTE | COEFFICIENT | COEFFICIENT

1,8



ARTICLE | ARTICOLO | ARTICLE

BI310



Exposed parts for manual wall mixer with two ways diverter

Miscelatore doccia a parete con deviatore due vie

Mitigeur douche mural deux voies avec inverseur

CODE / COEFFICIENT	CODICE / COEFFICIENTE	COEFFICIENT
CC	EBI310CC	7,3
SS	EBI310SS	9,1
ON	EBI310ON	7,3
BO	EBI310BO	8,8
NP	EBI310NP	8,8
CF	EBI310CF	11,0
CS	EBI310CS	11,7
II	EBI310II	11,0
IS	EBI310IS	11,7
RS	EBI310RS	11,0
SR	EBI310SR	11,7
OO	EBI310OO	11,0
OS	EBI310OS	11,7

PACKAGING

L: 150 mm
D: 190 mm
H: 98 mm
1,2 kg

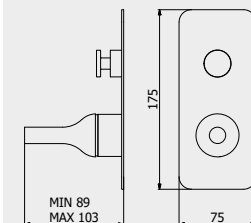

PORTATE | WATER FLOW | DÉBIT D'EAU

1 BAR	2 BAR	3 BAR
13,5 l/m	19 l/m	23,3 l/m

Built-in body to be purchased separately

Corpo incasso da acquistare separatamente

Corps intégré à acheter séparément



CODICE | CODE | CODE

INC310XXXN_19

COEFFICIENTE | COEFFICIENT | COEFFICIENT

3,3



ARTICLE | ARTICOLO | ARTICLE

BI312



Exposed parts for manual wall mixer with three ways diverter
Set di parti esterne per miscelatore a parete a tre vie
Mitigeur douche mural trois voies avec inverseur

CODE / COEFFICIENT	CODICE / COEFFICIENTE	CODE / COEFFICIENT
● CC	EBI312CC	7,8
● SS	EBI312SS	9,8
● BO	EBI312BO	9,4
● NP	EBI312NP	9,4
● CF	EBI312CF	11,7
● CS	EBI312CS	12,5
● II	EBI312II	11,7
● IS	EBI312IS	12,5
● RS	EBI312RS	11,7
● SR	EBI312SR	12,5
● OO	EBI312OO	11,7
● OS	EBI312OS	12,5

PACKAGING

L: 150 mm
D: 190 mm
H: 98 mm

1,2 kg

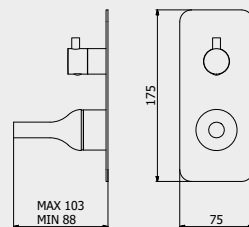

PORTATE | WATER FLOW | DÉBIT D'EAU

1 BAR	2 BAR	3 BAR
9,5 l/m	13,4 l/m	16,9 l/m

! Built-in body to be purchased separately

Corpo incasso da acquistare separatamente

Corps intégré à acheter séparément



CODICE | CODE | CODE

INC312XXXN_19

COEFFICIENTE | COEFFICIENT | COEFFICIENT

3,3

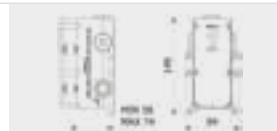

ARTICLE | ARTICOLO | ARTICLE

BI313



Exposed parts for manual wall mixer with 2 ways with shower kit
Set di parti esterne per miscelatore a parete a due vie completo di kit doccia
Partie extérieure pour mitigeur encastré à deux voies avec douchette

CODE / COEFFICIENT	CODICE / COEFFICIENTE	CODE / COEFFICIENT
● CC	EBI313CC	10,4
● SS	EBI313SS	13,0
● BO	EBI313BO	12,5
● NP	EBI313NP	12,5
● CF	EBI313CF	15,6
● CS	EBI313CS	16,6
● II	EBI313II	15,6
● IS	EBI313IS	16,6
● RS	EBI313RS	15,6
● SR	EBI313SR	16,6
● OO	EBI313OO	15,6
● OS	EBI313OS	16,6

PACKAGING

L: 370 mm
D: 270 mm
H: 80 mm

1,9 kg

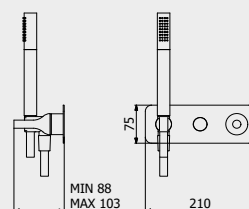

PORTATE | WATER FLOW | DÉBIT D'EAU

1 BAR	2 BAR	3 BAR
9,8 l/m	13,7 l/m	16,6 l/m

! Built-in body to be purchased separately

Corpo incasso da acquistare separatamente

Corps intégré à acheter séparément



CODICE | CODE | CODE

INC313XXXN_19

COEFFICIENTE | COEFFICIENT | COEFFICIENT

3,6



ARTICLE | ARTICOLO | ARTICLE

BI314



Exposed parts for manual wall mixer with 3 ways with shower kit
Set di parti esterne per miscelatore a parete a tre vie completo di kit doccia
Partie extérieure pour mitigeur encastré à trois voies avec douchette

CODE / COEFFICIENT	CODICE / COEFFICIENTE	CODE / COEFFICIENT
● CC	EBI314CC	11,8
● SS	EBI314SS	14,8
● BO	EBI314BO	14,2
● NP	EBI314NP	14,2
● CF	EBI314CF	17,7
● CS	EBI314CS	18,9
● II	EBI314II	17,7
● IS	EBI314IS	18,9
● RS	EBI314RS	17,7
● SR	EBI314SR	18,9
● OO	EBI314OO	17,7
● OS	EBI314OS	18,9

PACKAGING

L: 370 mm
D: 270 mm
H: 80 mm

1,9 kg

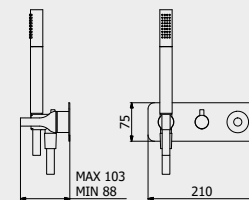

PORTATE | WATER FLOW | DÉBIT D'EAU

1 BAR	2 BAR	3 BAR
8 l/m	11 l/m	13,7 l/m

! Built-in body to be purchased separately

Corpo incasso da acquistare separatamente

Corps intégré à acheter séparément



CODICE | CODE | CODE

INC314XXXN_19

COEFFICIENTE | COEFFICIENT | COEFFICIENT

3,7



ARTICLE | ARTICOLO | ARTICLE

BI740



Two holes deck mounted bath filler mixer with shower kit
 Miscelatore Bordo vasca da appoggio due fori con doccia
 Mitigeur Bain/douche deux trous avec douchette

CODE / COEFFICIENT	CODICE / COEFFICIENTE	
CC	BI740CC	16,3
SS	BI740SS	20,4
CF	BI740CF	24,5
CS	BI740CS	26,1
II	BI740II	24,5
IS	BI740IS	26,1
RS	BI740RS	24,5
SR	BI740SR	26,1
OO	BI740OO	24,5
OS	BI740OS	26,1

PACKAGING

L: 360 mm
 D: 220 mm
 H: 150 mm
 4,9 kg

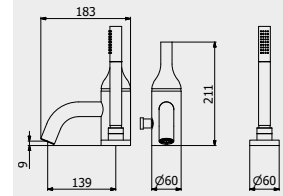

PORTATE | WATER FLOW | DÉBIT D'EAU

1 BAR	2 BAR	3 BAR
20,5 l/m	29 l/m	35,7 l/m

ARTICLE | ARTICOLO | ARTICLE

BI750



Deck mounted bath filler mixer
 Miscelatore bordo vasca da appoggio
 Mitigeur bain/douche

CODE / COEFFICIENT	CODICE / COEFFICIENTE	
CC	BI750CC	12,1
SS	BI750SS	15,1
CF	BI750CF	18,2
CS	BI750CS	19,4
II	BI750II	18,2
IS	BI750IS	19,4
RS	BI750RS	18,2
SR	BI750SR	19,4
OO	BI750OO	18,2
OS	BI750OS	19,4

PACKAGING

L: 360 mm
 D: 220 mm
 H: 150 mm
 3,6 kg

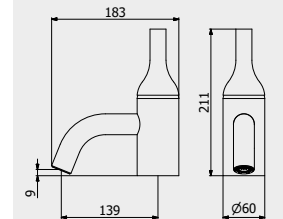

PORTATE | WATER FLOW | DÉBIT D'EAU

1 BAR	2 BAR	3 BAR
20,5 l/m	29 l/m	35,7 l/m

Batlo

ARTICLE | ARTICOLO | ARTICLE

BI250



Wall mounted bath filler complete with hand shower kit
 Bordo vasca esterno a parete completo di kit doccia
 Mitigeur Bain/douche Mural avec douchette encastrée

CODE / COEFFICIENT	CODICE / COEFFICIENTE	
CC	BI250CC	14,6
SS	BI250SS	18,3
BO	BI250BO	17,5
NP	BI250NP	17,5
CF	BI250CF	21,9
CS	BI250CS	23,4
II	BI250II	21,9
IS	BI250IS	23,4
RS	BI250RS	21,9
SR	BI250SR	23,4
OO	BI250OO	21,9
OS	BI250OS	23,4

PACKAGING

L: 360 mm
 D: 220 mm
 H: 150 mm
 4,7 kg

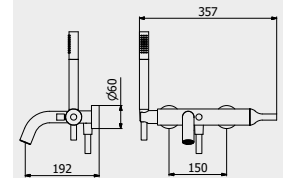

PORTATE | WATER FLOW | DÉBIT D'EAU

1 BAR	2 BAR	3 BAR
10 l/m	14 l/m	18 l/m

ARTICLE | ARTICOLO | ARTICLE

BI350



Wall mounted shower mixer with shower kit
 Doccia esterno a parete completo di kit doccia
 Mitigeur de douche externe avec flexible et douchette

CODE / COEFFICIENT	CODICE / COEFFICIENTE	
CC	BI350CC	12,7
SS	BI350SS	15,9
BO	BI350BO	15,2
NP	BI350NP	15,2
CF	BI350CF	19,1
CS	BI350CS	20,3
II	BI350II	19,1
IS	BI350IS	20,3
RS	BI350RS	19,1
SR	BI350SR	20,3
OO	BI350OO	19,1
OS	BI350OS	20,3

PACKAGING

L: 360 mm
 D: 220 mm
 H: 150 mm
 4,2 kg

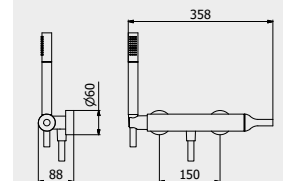

PORTATE | WATER FLOW | DÉBIT D'EAU

1 BAR	2 BAR	3 BAR
12,4 l/m	17,6 l/m	22 l/m

ARTICLE | ARTICOLO | ARTICLE

BI396



Five holes deck mounted bath filler with shower kit

Bordo vasca cinque fori con deviatore e kit doccia

Bain/douche cinq trous avec inverseur et Kit douche

CODE / COEFFICIENT | CODICE /
COEFFICIENTE | CODE / COEFFICIENT

● CC	BI396CC	19,1
● SS	BI396SS	23,9
● BO	BI396BO	22,9
● NP	BI396NP	22,9
● CF	BI396CF	28,7
● CS	BI396CS	30,6
● II	BI396II	28,7
● IS	BI396IS	30,6
● RS	BI396RS	28,7
● SR	BI396SR	30,6
● OO	BI396OO	28,7
● OS	BI396OS	30,6

PACKAGING

L: 400 mm
D: 250 mm
H: 140 mm

4,2 kg

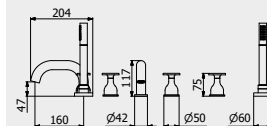

PORTATE | WATER FLOW | DÉBIT D'EAU

1 BAR	2 BAR	3 BAR
14 l/m	19 l/m	24 l/m

ARTICLE | ARTICOLO | ARTICLE

BI397



4 holes bath filler with overflow outlet connection, diverter and shower kit

Bordo vasca 4 fori per colonna riempimento con deviatore e kit doccia

Bain/douche 4 trous avec inverseur et Kit Douche pour remplissage ETP

CODE / COEFFICIENT | CODICE /
COEFFICIENTE | CODE / COEFFICIENT

● CC	BI397CC	15,5
● SS	BI397SS	19,4
● BO	BI397BO	18,6
● NP	BI397NP	18,6
● CF	BI397CF	23,3
● CS	BI397CS	24,8
● II	BI397II	23,3
● IS	BI397IS	24,8
● RS	BI397RS	23,3
● SR	BI397SR	24,8
● OO	BI397OO	23,3
● OS	BI397OS	24,8

PACKAGING

L: 400 mm
D: 250 mm
H: 140 mm

2,5 kg

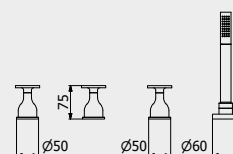

PORTATE | WATER FLOW | DÉBIT D'EAU

1 BAR	2 BAR	3 BAR
12 l/m	17 l/m	22 l/m

ARTICLE | ARTICOLO | ARTICLE

BI399



Free-standing bath filler with shower kit

Bordo vasca da terra con kit doccia

Bain douche complet alimentation au sol

CODE / COEFFICIENT | CODICE /
COEFFICIENTE | CODE / COEFFICIENT

● CC	EBI399CC	38,6
● SS	EBI399SS	48,3
● BO	EBI399BO	46,3
● NP	EBI399NP	46,3
● CF	EBI399CF	57,9
● CS	EBI399CS	61,8
● II	EBI399II	57,9
● IS	EBI399IS	61,8
● RS	EBI399RS	57,9
● SR	EBI399SR	61,8
● OO	EBI399OO	57,9
● OS	EBI399OS	61,8

PACKAGING

L: 1160 mm
D: 360 mm
H: 180 mm

15,6 kg

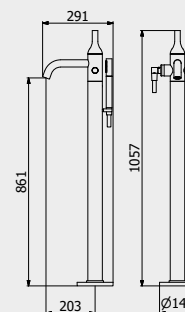

PORTATE | WATER FLOW | DÉBIT D'EAU

1 BAR	2 BAR	3 BAR
14 l/m	19 l/m	24 l/m

Built-in body to be purchased separately
AVAILABLE FROM JANUARY 2020Corpo incasso da acquistare separatamente
DISPONIBILE DA GENNAIO 2020Corps intégré à acheter séparément
DISPONIBLE À PARTIR DE JANVIER 2020

CODICE | CODE | CODE

INC399XXXN_19

COEFFICIENTE | COEFFICIENT | COEFFICIENT

2,8

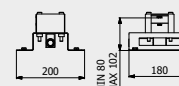

ARTICLE | ARTICOLO | ARTICLE

RU319



Wall mounted waterfall

Cascata a parete con erogazione diretta

Cascade murale

CODE / COEFFICIENT | CODICE /
COEFFICIENTE | CODE / COEFFICIENT

CC	RU319CC	12,8
SS	RU319SS	16,0
BO	RU319BO	15,4
NP	RU319NP	15,4
CF	RU319CF	19,2
CS	RU319CS	20,5
II	RU319II	19,2
IS	RU319IS	20,5
RS	RU319RS	19,2
SR	RU319SR	20,5
OO	RU319OO	19,2
OS	RU319OS	20,5

PACKAGING

L: 340 mm
D: 180 mm
H: 70 mm

3,1 kg

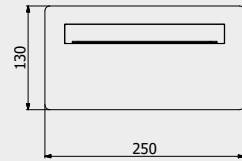

PORTATE | WATER FLOW | DÉBIT D'EAU

1 BAR	2 BAR	3 BAR
13 l/m	17,7 l/m	20 l/m

ARTICLE | ARTICOLO | ARTICLE

BI320



Wall mounted spout

Bocca d'erogazione a parete

Bec de remplissage mural

CODE / COEFFICIENT | CODICE /
COEFFICIENTE | CODE / COEFFICIENT

CC	MT320CC	2,1
SS	MT320SS	2,6
BO	MT320BO	2,5
NP	MT320NP	2,5
CF	MT320CF	3,2
CS	MT320CS	3,4
II	MT320II	3,2
IS	MT320IS	3,4
RS	MT320RS	3,2
SR	MT320SR	3,4
OO	MT320OO	3,2
OS	MT320OS	3,4

PACKAGING

L: 175 mm
D: 125 mm
H: 90 mm

0,2 kg

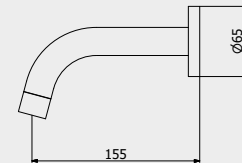

PORTATE | WATER FLOW | DÉBIT D'EAU

1 BAR	2 BAR	3 BAR
6,5 l/m	8 l/m	8 l/m

ARTICLE | ARTICOLO | ARTICLE

BI321



Short wall mounted spout

Bocca d'erogazione corta a parete

Bec de remplissage mural court

CODE / COEFFICIENT | CODICE /
COEFFICIENTE | CODE / COEFFICIENT

CC	MT321CC	2,5
SS	MT321SS	3,1
BO	MT321BO	3,0
NP	MT321NP	3,0
CF	MT321CF	3,8
CS	MT321CS	4,0
II	MT321II	3,8
IS	MT321IS	4,0
RS	MT321RS	3,8
SR	MT321SR	4,0
OO	MT321OO	3,8
OS	MT321OS	4,0

PACKAGING

L: 175 mm
D: 125 mm
H: 90 mm

0,2 kg

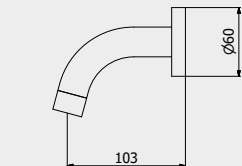

PORTATE | WATER FLOW | DÉBIT D'EAU

1 BAR	2 BAR	3 BAR
6,5 l/m	8 l/m	8 l/m

ARTICLE | ARTICOLO | ARTICLE

BI322



Long wall mounted spout

Bocca d'erogazione lunga a parete

Bec de remplissage mural long

CODE / COEFFICIENT | CODICE /
COEFFICIENTE | CODE / COEFFICIENT

CC	MT322CC	2,5
SS	MT322SS	3,1
BO	MT322BO	3,0
NP	MT322NP	3,0
CF	MT322CF	3,8
CS	MT322CS	4,0
II	MT322II	3,8
IS	MT322IS	4,0
RS	MT322RS	3,8
SR	MT322SR	4,0
OO	MT322OO	3,8
OS	MT322OS	4,0

PACKAGING

L: 175 mm
D: 125 mm
H: 90 mm

0,2 kg

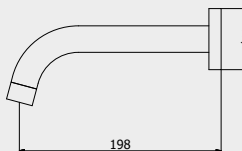

PORTATE | WATER FLOW | DÉBIT D'EAU

1 BAR	2 BAR	3 BAR
6,5 l/m	8 l/m	8 l/m

ARTICLE | ARTICOLO | ARTICLE

BI706



Exposed parts for bidet spray complete with mixer

Set di parti esterne per Idroscopino igienico con miscelatore

Partie extérieure pour douchette hygiénique avec mitigeur

CODE / COEFFICIENT	CODICE / COEFFICIENTE	CODE / COEFFICIENT
● CC	EBI706CC	9,9
● SS	EBI706SS	12,4
● BO	EBI706EBO	11,9
● NP	EBI706NP	11,9
● CF	EBI706CF	14,9
● CS	EBI706CS	15,8
● II	EBI706II	14,9
● IS	EBI706IS	15,8
● RS	EBI706RS	14,9
● SR	EBI706SR	15,8
● OO	EBI706OO	14,9
● OS	EBI706OS	15,8

PACKAGING

L: 370 mm
D: 270 mm
H: 80 mm

3,1 kg

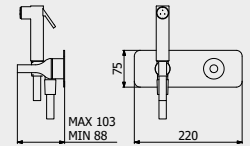

PORTATE | WATER FLOW | DÉBIT D'EAU

1 BAR	2 BAR	3 BAR
2,3 l/m	3,2 l/m	4 l/m

Built-in body to be purchased separately

Corpo incasso da acquistare separatamente

Corps intégré à acheter séparément



CODICE | CODE | CODE

INC206XXXN_19

COEFFICIENTE | COEFFICIENT | COEFFICIENT

2,9

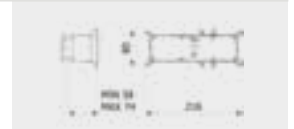

ARTICLE | ARTICOLO | ARTICLE

BI370



Single Lever kitchen mixer

Miscelatore lavello monoforo

Évier de cuisine

CODE / COEFFICIENT	CODICE / COEFFICIENTE	CODE / COEFFICIENT
● CC	BI370CC	10,8
● SS	BI370SS	13,5
● BO	BI370BO	13,0
● NP	BI370NP	13,0
● CF	BI370CF	16,2
● CS	BI370CS	17,3
● II	BI370II	16,2
● IS	BI370IS	17,3
● RS	BI370RS	16,2
● SR	BI370SR	17,3
● OO	BI370OO	16,2
● OS	BI370OS	17,3

PACKAGING

L: 425 mm
D: 188 mm
H: 98 mm

2,7 kg

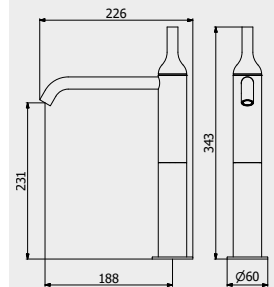

PORTATE | WATER FLOW | DÉBIT D'EAU

1 BAR	2 BAR	3 BAR
9,2 l/m	13,3 l/m	16,6 l/m



SNATCH / ACCESSORIES COLLECTION

ARTICLE | ARTICOLO | ARTICLE

HJ001



Wall soap-holder
Porta sapone a muro
Porte distributeur de savon encastré

**CODICE / COEFFICIENTE | CODE /
COEFFICIENT | CODE / COEFFICIENT**

☐ CC	HJ001CC	5,5
☐ SS	HJ001SS	5,7
☐ BO	HJ001BO	5,7
● NP	HJ001NP	5,7
● CF	HJ001CF	5,7
● CS	HJ001CS	5,7
● II	HJ001II	5,7
● IS	HJ001IS	5,7
● RS	HJ001RS	5,7
● SR	HJ001SR	5,7
● OO	HJ001OO	5,7
● OS	HJ001OS	5,7

PACKAGING

☐	L: 150 mm	⚖	0,4 kg
	D: 190 mm		
	H: 98 mm		

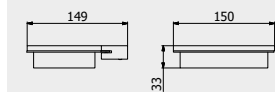

ARTICLE | ARTICOLO | ARTICLE

HJ003



Wall toothbrush holder
Porta spazzolino a muro
Porte brosse à dents encastré

**CODICE / COEFFICIENTE | CODE /
COEFFICIENT | CODE / COEFFICIENT**

☐ CC	HJ003CC	6,1
☐ SS	HJ003SS	6,3
☐ BO	HJ003BO	6,3
● NP	HJ003NP	6,3
● CF	HJ003CF	6,3
● CS	HJ003CS	6,3
● II	HJ003II	6,3
● IS	HJ003IS	6,3
● RS	HJ003RS	6,3
● SR	HJ003SR	6,3
● OO	HJ003OO	6,3
● OS	HJ003OS	6,3

PACKAGING

☐	L: 175 mm	⚖	0,2 kg
	D: 125 mm		
	H: 90 mm		

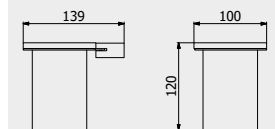

ARTICLE | ARTICOLO | ARTICLE

HJ016



Soap dispenser
Porta sapone da appoggio
Porte distributeur de savon

**CODICE / COEFFICIENTE | CODE /
COEFFICIENT | CODE / COEFFICIENT**

☐ CC	HJ016CC	2,2
☐ SS	HJ016SS	2,4
☐ BO	HJ016BO	2,4
● NP	HJ016NP	2,4
● CF	HJ016CF	2,4
● CS	HJ016CS	2,4
● II	HJ016II	2,4
● IS	HJ016IS	2,4
● RS	HJ016RS	2,4
● SR	HJ016SR	2,4
● OO	HJ016OO	2,4
● OS	HJ016OS	2,4

PACKAGING

☐	L: 150 mm	⚖	1,1 kg
	D: 190 mm		
	H: 98 mm		

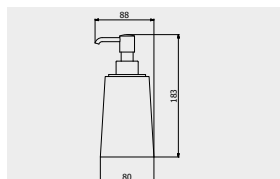

ARTICLE | ARTICOLO | ARTICLE

HJ017



Soap holder
Porta sapone da appoggio
Porte savon

**CODE / COEFFICIENT | CODE /
COEFFICIENT | CODE / COEFFICIENT**

☐ CC	HJ017CC	3,8
------	---------	-----

PACKAGING

☐	L: 175 mm	⚖	0,5 kg
	D: 125 mm		
	H: 90 mm		

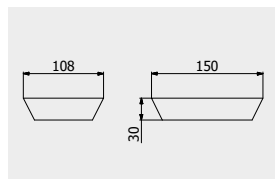

ARTICLE | ARTICOLO | ARTICLE

HJ010

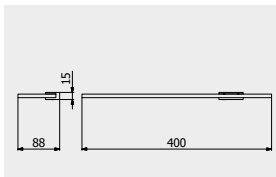

Shelf

Mensola

Étagère

CODICE / COEFFICIENTE | CODE /
COEFFICIENT | CODE / COEFFICIENT

CC	HJ010CC	5,1
SS	HJ010SS	5,3
BO	HJ010BO	5,3
NP	HJ010NP	5,3
CF	HJ010CF	5,3
CS	HJ010CS	5,3
II	HJ010II	5,3
IS	HJ010IS	5,3
RS	HJ010RS	5,3
SR	HJ010SR	5,3
OO	HJ010OO	5,3
OS	HJ010OS	5,3

PACKAGING

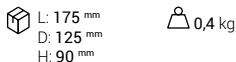

ARTICLE | ARTICOLO | ARTICLE

HJ011

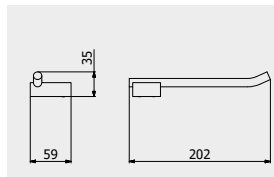

Toilet paper holder

Porta rotolo

Porte rouleaux de toilette

CODICE / COEFFICIENTE | CODE /
COEFFICIENT | CODE / COEFFICIENT

CC	HJ011CC	3,5
SS	HJ011SS	4,4
BO	HJ011BO	4,4
NP	HJ011NP	4,2
CF	HJ011CF	5,3
CS	HJ011CS	5,7
II	HJ011II	5,3
IS	HJ011IS	5,7
RS	HJ011RS	5,3
SR	HJ011SR	5,7
OO	HJ011OO	5,7
OS	HJ011OS	5,3

PACKAGING

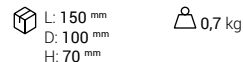

ARTICLE | ARTICOLO | ARTICLE

HJ009

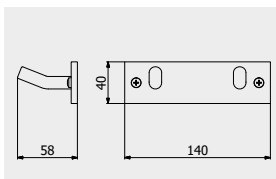

Double robe hook

Doppio appendino a parete

Double cintre

CODICE / COEFFICIENTE | CODE /
COEFFICIENT | CODE / COEFFICIENT

CC	HJ009CC	3,4
SS	HJ009SS	4,3
BO	HJ009BO	4,3
NP	HJ009NP	4,3
CF	HJ009CF	5,1
CS	HJ009CS	5,4
II	HJ009II	5,4
IS	HJ009IS	5,4
RS	HJ009RS	5,1
SR	HJ009SR	5,4
OO	HJ009OO	5,1
OS	HJ009OS	5,4

PACKAGING

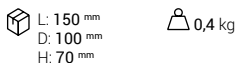

ARTICLE | ARTICOLO | ARTICLE

HJ004

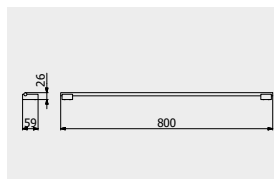

Towel holder

Porta salvietta

Porte-serviette

CODICE / COEFFICIENTE | CODE /
COEFFICIENT | CODE / COEFFICIENT

CC	HJ004CC	7,5
SS	HJ004SS	9,4
BO	HJ004BO	9,4
NP	HJ004NP	9,4
CF	HJ004CF	11,3
CS	HJ004CS	12,0
II	HJ004II	11,3
IS	HJ004IS	12,0
RS	HJ004RS	11,3
SR	HJ004SR	12,0
OO	HJ004OO	11,3
OS	HJ004OS	12,0

PACKAGING

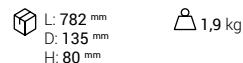

ARTICLE | ARTICOLO | ARTICLE

HJ014

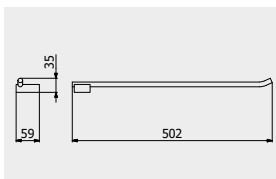

Towel holder

Porta salvietta

Porte-serviette

CODICE / COEFFICIENTE | CODE /
COEFFICIENT | CODE / COEFFICIENT

CC	HJ014CC	5,1
SS	HJ014SS	6,4
BO	HJ014BO	6,4
NP	HJ014NP	6,4
CF	HJ014CF	7,7
CS	HJ014CS	8,2
II	HJ014II	7,7
IS	HJ014IS	8,2
RS	HJ014RS	7,7
SR	HJ014SR	8,2
OO	HJ014OO	7,7
OS	HJ014OS	8,2

PACKAGING

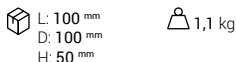

ARTICLE | ARTICOLO | ARTICLE

HJ006

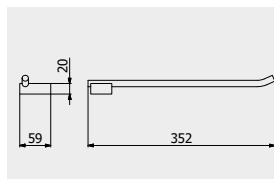

Towel holder

Porta salvietta

Porte-serviette

CODICE / COEFFICIENTE | CODE /
COEFFICIENT | CODE / COEFFICIENT

CC	HJ006CC	4,9
SS	HJ006SS	6,1
BO	HJ006BO	6,1
NP	HJ006NP	6,1
CF	HJ006CF	7,4
CS	HJ006CS	7,8
II	HJ006II	7,4
IS	HJ006IS	7,8
RS	HJ006RS	7,4
SR	HJ006SR	7,8
OO	HJ006OO	7,4
OS	HJ006OS	7,8

PACKAGING

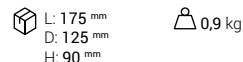

ARTICLE | ARTICOLO | ARTICLE

HJ007

Ring Towel holder

Porta salvietta ad anello

Porte-serviette anneau

CODICE / COEFFICIENTE | CODE / COEFFICIENT

CC	HJ007CC	5,0
SS	HJ007SS	6,3
BO	HJ007BO	6,3
NP	HJ007NP	6,3
CF	HJ007CF	7,5
CS	HJ007CS	8,0
II	HJ007II	7,5
IS	HJ007IS	8,0
RS	HJ007RS	7,5
SR	HJ007SR	8,0
OO	HJ007OO	7,5
OS	HJ007OS	8,0

PACKAGING

L:	340 mm	Weight icon	1,9 kg
D:	180 mm		
H:	70 mm		

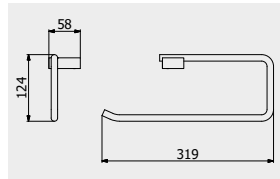

ARTICLE | ARTICOLO | ARTICLE

HJ015

Toothbrush holder

Porta spazzolino

Porte brosse à dents

CODICE / COEFFICIENTE | CODE / COEFFICIENT

CC	HJ015CC	2,8
----	---------	-----

PACKAGING

L:	175 mm	Weight icon	0,6 kg
D:	125 mm		
H:	90 mm		

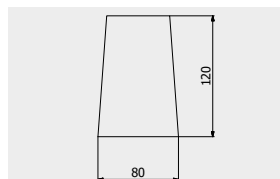

ARTICLE | ARTICOLO | ARTICLE

HJ012

Toilet brush holder

Porta scopino da terra

Porte balayette au sol

CODICE / COEFFICIENTE | CODE / COEFFICIENT

CC	HJ012CC	7,8
SS	HJ012SS	9,8
BO	HJ012BO	9,8
NP	HJ012NP	9,8
CF	HJ012CF	11,7
CS	HJ012CS	12,5
II	HJ012II	11,7
IS	HJ012IS	12,5
RS	HJ012RS	11,7
SR	HJ012SR	12,5
OO	HJ012OO	11,7
OS	HJ012OS	12,5

PACKAGING

L:	100 mm	Weight icon	1,8 kg
D:	100 mm		
H:	50 mm		

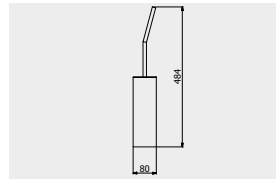

ARTICLE | ARTICOLO | ARTICLE

HJ018

Box

Scatola

Boîte

CODICE / COEFFICIENTE | CODE / COEFFICIENT

CC	HJ018CC	4,1
SS	HJ018SS	4,3
BO	HJ018BO	4,3
NP	HJ018NP	4,3
CF	HJ018CF	4,3
CS	HJ018CS	4,3
II	HJ018II	4,3
IS	HJ018IS	4,3
RS	HJ018RS	4,3
SR	HJ018SR	4,3
OO	HJ018OO	4,3
OS	HJ018OS	4,3

PACKAGING

L:	240 mm	Weight icon	1,2 kg
D:	215 mm		
H:	110 mm		

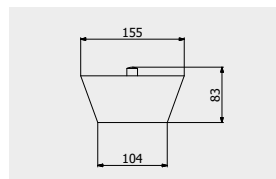

Batlò

ONLYONE

Simplify everything in a single gesture.

Semplificare tutto in un unico gesto.
Simplifiez tout à travers un seul geste.

Innovation begins with the discovery of ancient forms for new purposes. In ONLY ONE, the features of a traditional tube, as a typical industrial water container, shape a new product with a traditional and yet original design.

Innovation also means to combine aesthetics and high practicality: that's why ONLY ONE focuses on a fast and simple gestural action, enabling to open and direct the water flow with just one hand, thus creating the effect of a small man-operated waterfall.

L'innovazione parte dalla riscoperta di antiche forme per nuovi utilizzi.

In ONLY ONE, le fattezze di un tubo, tradizionale contenitore industriale d'acqua, modellano un nuovo prodotto, dal design tradizionale e al contempo originale.

Innovazione significa anche affiancare estetica e alta funzionalità: ecco perché ONLY ONE punta su una gestualità veloce e semplice, che con una sola mano permette di aprire e direzionare il flusso d'acqua, creando l'effetto di una piccola cascata manovrata dall'uomo.

L'innovation commence par la redécouverte de formes anciennes pour des nouveaux usages. Dans ONLY ONE, les formes d'un tuyau, le traditionnel réservoir d'eau industriel, façonnent un nouveau produit au design à la fois traditionnel et original. Innovation c'est aussi allier esthétique et haute fonctionnalité: c'est pourquoi ONLY ONE se concentre sur une gestualité simple et rapide qui, d'une seule main, ouvre et dirige l'écoulement d'eau, créant ainsi l'effet d'une petite cascade manœuvrée par l'homme.



LEAD FREE



ZINC FREE



CASCADE





Onlyone

DESIGN
LORENZO DAMIANI

“ With this product, I wanted to go back to the archetype of water distribution: a simple tube (originally a hose), from which water flows without technological mediations. The innovation lies in water management, where the whole body becomes the handle.”

Con questo prodotto ho voluto ritornare all'archetipo della distribuzione dell'acqua: un semplice tubo (all'origine canna) dal quale sgorga senza mediazioni tecnologiche. L'invenzione sta nella gestione dell'acqua dove tutto il corpo diventa maniglia.

Avec ce produit, j'ai voulu revenir à l'archétype de la distribution de l'eau: un tube simple (à l'origine un tuyau d'arrosage) duquel elle jaillit sans médiation technologique. L'innovation concerne la gestion de l'eau, du moment que le corps entier du robinet devient la poignée de commande. ”

Lorenzo Damiani design for ONLYONE

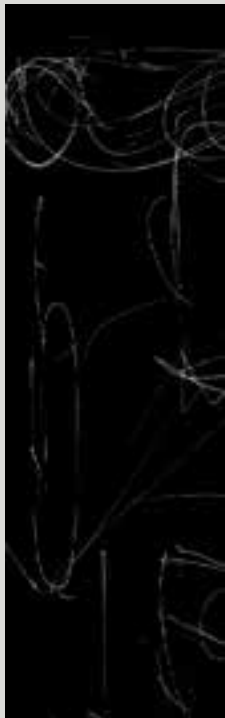



Onlyone



- ↑ 00200CC
Monohole washbasin mixer
Miscelatore lavabo monoforo
Mitigeur lavabo
- 00202CC
Tall monohole washbasin mixer
Miscelatore lavabo monoforo alto
Mitigeur lavabo haut



Onlyone





Onlyone

← 00200CC
Monohole washbasin mixer
Miscelatore lavabo monoforo
Mitigeur lavabo

↗ 00392CC
Three holes washbasin set with low spout
Lavabo tre fori a bocca bassa
Lavabo trois trous bec bas

→ 00209CC
Wall mounted washbasin mixer
Miscelatore lavabo a parete
Mitigeur lavabo mural





- ↖ 00350CC
Wall mounted shower mixer with shower kit
Doccia esterno a parete completo di kit doccia
Mitigeur de douche externe avec flexible et douchette

- 00800CC
Shower column with mixer and shower kit
Colonna doccia con miscelatore e e kit doccia
Colonne de douche avec mitigeur et kit douche







Onlyone

← 00314CC

Three ways wall shower mixer complete with shower kit

Miscelatore doccia a parete con deviatore tre vie e doccia integrato

Mitigeur douche mural trois voies avec inverseur et douchette encastrée

↑ 00250CC

→ Wall mounted bath filler complete with hand shower kit

Bordo vasca esterno a parete completo di kit doccia

Mitigeur Bain/douche Mural avec douchette encastrée





↑ 00399CC

Free-standing bath filler with shower kit
Bordo vasca da terra con kit doccia
Bain douche complet alimentation au sol



ARTICLE | ARTICOLO | ARTICLE

00200



Monohole washbasin mixer complete with drain
 Miselatore lavabo monoforo completo di scarico automatico
 Mitigeur lavabo complet avec bonde automatique

CODICE / COEFFICIENTE | CODE / COEFFICIENT
 CC 00200CC 12,5

PACKAGING

L: 340 mm
 D: 180 mm
 H: 70 mm

2,5 kg

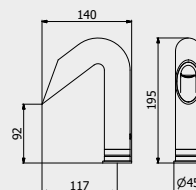

PORTATE | WATER FLOW | DÉBIT D'EAU

1 BAR	2 BAR	3 BAR
5,8 l/m	8,4 l/m	10,3 l/m

ARTICLE | ARTICOLO | ARTICLE

00202



Tall monohole washbasin mixer complete with drain
 Miselatore lavabo monoforo alto completo di scarico automatico
 Mitigeur lavabo haut complet avec bonde automatique

CODICE / COEFFICIENTE | CODE / COEFFICIENT
 CC 00202CC 14,8

PACKAGING

L: 425 mm
 D: 188 mm
 H: 98 mm

3,1 kg

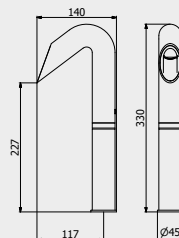

PORTATE | WATER FLOW | DÉBIT D'EAU

1 BAR	2 BAR	3 BAR
5,8 l/m	8,4 l/m	10,3 l/m

Onlyone

ARTICLE | ARTICOLO | ARTICLE

00209



Wall mounted washbasin mixer complete with drain
 Miselatore lavabo a parete completo di scarico automatico
 Mitigeur lavabo mural complet avec bonde automatique

CODICE / COEFFICIENTE | CODE / COEFFICIENT
 CC 00209CC 13,3

PACKAGING

L: 340 mm
 D: 180 mm
 H: 70 mm

2,0 kg

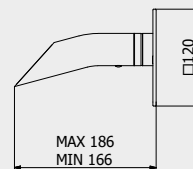

PORTATE | WATER FLOW | DÉBIT D'EAU

1 BAR	2 BAR	3 BAR
5,5 l/m	7,5 l/m	9,3 l/m

ARTICLE | ARTICOLO | ARTICLE

00220



Monohole bidet mixer complete with drain

Miscelatore bidet monoforo completo di scarico automatico

Mitigeur bidet complet avec bonde automatique

CODICE / COEFFICIENTE | CODE /
COEFFICIENT | CODE / COEFFICIENT

CC 00220CC 12,5

PACKAGING

L: 340 mm
D: 180 mm
H: 70 mm

2,3 kg

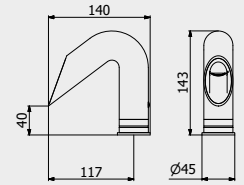

PORTATE | WATER FLOW | DÉBIT D'EAU

1 BAR	2 BAR	3 BAR
5,8 l/m	8,4 l/m	10,3 l/m

ARTICLE | ARTICOLO | ARTICLE

00300



Exposed parts for manual wall mixer

Set di parti esterne per miscelatore a parete ad una via

Partie extérieure pour mitigeur encastré à une voie

CODICE / COEFFICIENTE | CODE /
COEFFICIENT | CODE / COEFFICIENT

CC E00300CC 4,1

PACKAGING

L: 150 mm
D: 190 mm
H: 98 mm

1,4 kg

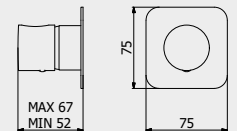

PORTATE | WATER FLOW | DÉBIT D'EAU

1 BAR	2 BAR	3 BAR
11,5 l/m	16,3 l/m	20 l/m

Built-in body to be purchased
separatelyCorpo incasso da acquistare
separatamenteCorps intégré à acheter
séparément

CODICE | CODE | CODE

INC300XXXN_19

COEFFICIENTE | COEFFICIENT | COEFFICIENT

1,8

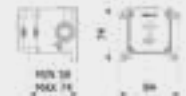

ARTICLE | ARTICOLO | ARTICLE

00310



Exposed parts for manual wall mixer with two ways diverter

Miscelatore doccia a parete con deviatore due vie

Mitigeur douche mural deux voies avec inverseur

CODICE / COEFFICIENTE | CODE /
COEFFICIENT | CODE / COEFFICIENT

CC E00310CC 6,1

PACKAGING

L: 150 mm
D: 190 mm
H: 98 mm

2,0 kg

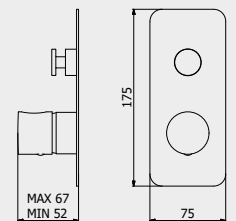

PORTATE | WATER FLOW | DÉBIT D'EAU

1 BAR	2 BAR	3 BAR
9,2 l/m	12,8 l/m	16 l/m

Built-in body to be purchased
separatelyCorpo incasso da acquistare
separatamenteCorps intégré à acheter
séparément

CODICE | CODE | CODE

INC310XXXN_19

COEFFICIENTE | COEFFICIENT | COEFFICIENT

3,3



ARTICLE | ARTICOLO | ARTICLE

00312



Exposed parts for manual wall mixer with three ways diverter
Set di parti esterne per miscelatore a parete a tre vie
Mitigeur douche mural trois voies avec inverseur



CODICE / COEFFICIENTE | CODE / COEFFICIENT
CC E00312CC 7,4

PACKAGING

L: 150 mm
D: 190 mm
H: 98 mm
2,4 kg

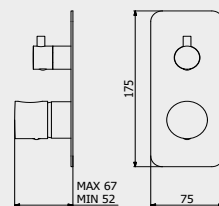

PORTATE | WATER FLOW | DÉBIT D'EAU

1 BAR	2 BAR	3 BAR
8,3 l/m	11,7 l/m	14,3 l/m

Built-in body to be purchased separately

Corpo incasso da acquistare separatamente
Corps intégré à acheter séparément



CODICE | CODE | CODE

INC312XXXN_19

COEFFICIENTE | COEFFICIENT | COEFFICIENT

3,3

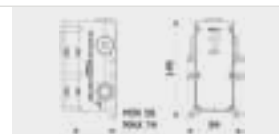

ARTICLE | ARTICOLO | ARTICLE

00313



Exposed parts for manual wall mixer with 2 ways with shower kit
Set di parti esterne per miscelatore a parete a due vie completo di kit doccia
Partie extérieure pour mitigeur encastré à deux voies avec douchette



CODICE / COEFFICIENTE | CODE / COEFFICIENT
CC E00313CC 10,1

PACKAGING

L: 370 mm
D: 270 mm
H: 80 mm
2,6 kg

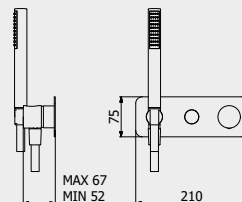

PORTATE | WATER FLOW | DÉBIT D'EAU

1 BAR	2 BAR	3 BAR
10 l/m	14,1 l/m	17,2 l/m

Built-in body to be purchased separately

Corpo incasso da acquistare separatamente
Corps intégré à acheter séparément



CODICE | CODE | CODE

INC313XXXN_19

COEFFICIENTE | COEFFICIENT | COEFFICIENT

3,6



Onlyone

ARTICLE | ARTICOLO | ARTICLE

00314



Exposed parts for manual wall mixer with 3 ways with shower kit
Set di parti esterne per miscelatore a parete a tre vie completo di kit doccia
Partie extérieure pour mitigeur encastré à trois voies avec douchette



CODICE / COEFFICIENTE | CODE / COEFFICIENT
CC E00314CC 11,4

PACKAGING

L: 370 mm
D: 270 mm
H: 80 mm
2,9 kg

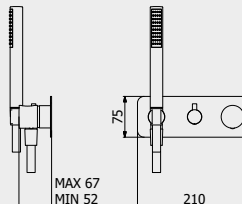

PORTATE | WATER FLOW | DÉBIT D'EAU

1 BAR	2 BAR	3 BAR
8,3 l/m	11,7 l/m	14,3 l/m

Built-in body to be purchased separately

Corpo incasso da acquistare separatamente
Corps intégré à acheter séparément



CODICE | CODE | CODE

INC314XXXN_19

COEFFICIENTE | COEFFICIENT | COEFFICIENT

3,7

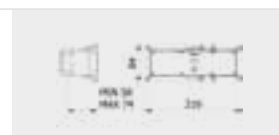

ARTICLE | ARTICOLO | ARTICLE

00250



Wall mounted bath filler complete with hand shower kit

Bordo vasca esterno a parete completo di kit doccia

Mitigeur Bain/douche Mural avec douchette encastrée

CODICE / COEFFICIENTE | CODE /
COEFFICIENT | CODE / COEFFICIENT

CC 00250CC 23,4

PACKAGING

L: 400 mm
D: 250 mm
H: 140 mm

5,3 kg

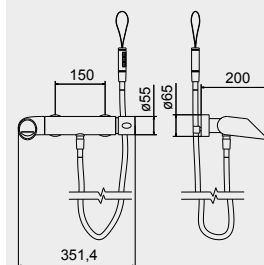

PORTATE | WATER FLOW | DÉBIT D'EAU

1 BAR	2 BAR	3 BAR
13 l/m	19,5 l/m	24 l/m

ARTICLE | ARTICOLO | ARTICLE

00350



Wall mounted shower mixer with shower kit

Doccia esterno a parete completo di kit doccia

Mitigeur de douche externe avec flexible et douchette

CODICE / COEFFICIENTE | CODE /
COEFFICIENT | CODE / COEFFICIENT

CC 00350CC 16,9

PACKAGING

L: 360 mm
D: 220 mm
H: 150 mm

3,6 kg

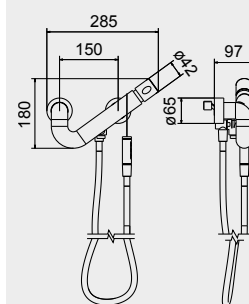

PORTATE | WATER FLOW | DÉBIT D'EAU

1 BAR	2 BAR	3 BAR
7,5 l/m	8,5 l/m	9,3 l/m

ARTICLE | ARTICOLO | ARTICLE

00740



2 holes deck mounted bath filler mixer with shower kit

Miscelatore bordo vasca da appoggio due fori con doccino

Mitigeur bain/douche 2 trous avec douchette

CODICE / COEFFICIENTE | CODE /
COEFFICIENT | CODE / COEFFICIENT

CC 00740CC 30,4

PACKAGING

L: 353 mm
D: 225 mm
H: 226 mm

7,1 kg

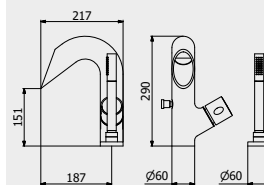

PORTATE | WATER FLOW | DÉBIT D'EAU

1 BAR	2 BAR	3 BAR
19 l/m	28 l/m	34 l/m



ARTICLE | ARTICOLO | ARTICLE

00750



Deck mounted bath filler mixer with shower kit

Miscelatore bordo vasca da appoggio

Mitigeur bain/douche

CODICE / COEFFICIENTE | CODE / COEFFICIENT
 CC 00750CC 24,8

PACKAGING

L: 353 mm
 D: 225 mm
 H: 226 mm

6,5 kg

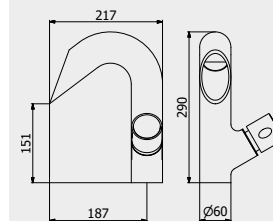

PORTATE | WATER FLOW | DÉBIT D'EAU

1 BAR	2 BAR	3 BAR
19 l/m	28 l/m	34 l/m

ARTICLE | ARTICOLO | ARTICLE

00396



Five holes deck mounted bath filler with shower kit

Bordo vasca cinque fori con deviatore e kit doccia

Bain/douche cinq trous avec inverseur et Kit Douche

CODICE / COEFFICIENTE | CODE / COEFFICIENT
 CC 00396CC 21,6

PACKAGING

L: 455 mm
 D: 310 mm
 H: 75 mm

5 kg

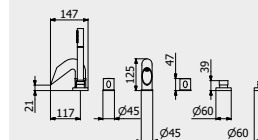

PORTATE | WATER FLOW | DÉBIT D'EAU

1 BAR	2 BAR	3 BAR
9 l/m	28 l/m	34 l/m

Onlyone

ARTICLE | ARTICOLO | ARTICLE

00397



4 holes bath filler with overflow outlet connection, diverter and shower kit

Bordo vasca 4 fori per colonna riempimento con deviatore e kit doccia

Bain/douche 4 trous avec inverseur et kit douche pour remplissage ETP

CODICE / COEFFICIENTE | CODE / COEFFICIENT
 CC 00397CC 14,3

PACKAGING

L: 455 mm
 D: 310 mm
 H: 75 mm

3,8 kg

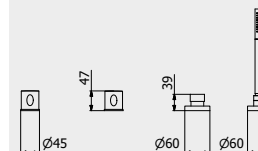

PORTATE | WATER FLOW | DÉBIT D'EAU

1 BAR	2 BAR	3 BAR
9 l/m	28 l/m	34 l/m

ARTICLE | ARTICOLO | ARTICLE

00399



Free-standing bath filler with shower kit

Bordo vasca da terra con kit doccia

Bain douche complet alimentation au sol

CODICE / COEFFICIENTE | CODICE /
COEFFICIENTE | CODE / COEFFICIENT

CC E00399CC 56,2

PACKAGING

L: 1160 mm
D: 360 mm
H: 180 mm

20,6 kg

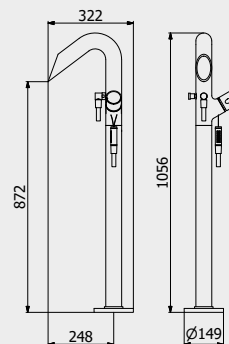

PORTATE | WATER FLOW | DÉBIT D'EAU

1 BAR 2 BAR 3 BAR
19 l/m 28 l/m 34 l/mBuilt-in body to be purchased separately
AVAILABLE FROM JANUARY 2020Corpo incasso da acquistare separatamente
DISPONIBILE DA GENNAIO 2020Corps intégré à acheter séparément
DISPONIBLE À PARTIR DE JANVIER 2020

CODICE | CODE | CODE

INC399XXXN_19

COEFFICIENTE | COEFFICIENT | COEFFICIENT

2,8

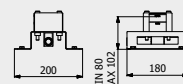

ARTICLE | ARTICOLO | ARTICLE

RU318



Built-in wall mounted waterfall spout

Cascata a parete con erogazione a lama esterna

Cascade murale avc bec externe

CODE / COEFFICIENTE | CODICE /
COEFFICIENTE | CODE / COEFFICIENT

CC RU318CC 22,9

SS RU318SS 28,6

BO RU318BO 27,5

NP RU318NP 27,5

CF RU318CF 34,4

CS RU318CS 36,6

II RU318II 34,4

IS RU318IS 36,6

RS RU318RS 34,4

SR RU318SR 36,6

OO RU318OO 34,4

OS RU318OS 36,6

PACKAGING

L: 340 mm
D: 180 mm
H: 70 mm

4,0 kg

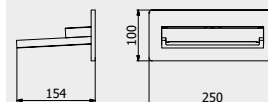

PORTATE | WATER FLOW | DÉBIT D'EAU

1 BAR 2 BAR 3 BAR
13 l/m 17 l/m 20 l/m

ARTICLE | ARTICOLO | ARTICLE

RU319



Wall mounted waterfall

Cascata a parete con erogazione diretta

Cascade murale

CODE / COEFFICIENTE | CODICE /
COEFFICIENTE | CODE / COEFFICIENT

CC RU319CC 12,8

SS RU319SS 16,0

BO RU319BO 15,4

NP RU319NP 15,4

CF RU319CF 19,2

CS RU319CS 20,5

II RU319II 19,2

IS RU319IS 20,5

RS RU319RS 19,2

SR RU319SR 20,5

OO RU319OO 19,2

OS RU319OS 20,5

PACKAGING

L: 340 mm
D: 180 mm
H: 70 mm

3,1 kg

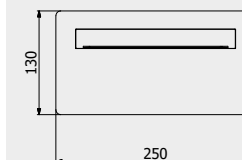

PORTATE | WATER FLOW | DÉBIT D'EAU

1 BAR 2 BAR 3 BAR
13 l/m 17,7 l/m 20 l/m

ARTICLE | ARTICOLO | ARTICLE

00320



Wall mounted spout

Bocca d'erogazione corta a parete

Bec de remplissage mural court

CODICE / COEFFICIENTE	CODE / COEFFICIENT	COEFFICIENT
CC	00320CC	7,1

PACKAGING

L: 150 mm
D: 190 mm
H: 98 mm

2,4 kg

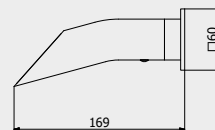

PORTATE | WATER FLOW | DÉBIT D'EAU

1 BAR	2 BAR	3 BAR
7,5 l/m	8,5 l/m	9,3 l/m

ARTICLE | ARTICOLO | ARTICLE

00800



Shower column with mixer and shower kit

Colonna doccia con miscelatore e e kit doccia

Colonne de douche avec mitigeur et kit douche

CODICE / COEFFICIENTE	CODE / COEFFICIENT	COEFFICIENT
CC	00800CC	52,5

PACKAGING

L: 1160 mm
D: 360 mm
H: 180 mm

14 kg

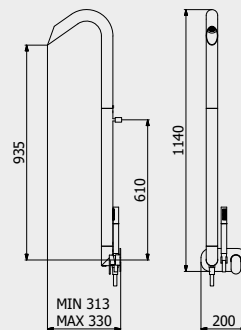

PORTATE | WATER FLOW | DÉBIT D'EAU

1 BAR	2 BAR	3 BAR
10 l/m	15 l/m	18,5 l/m

Onlyone

ARTICLE | ARTICOLO | ARTICLE

00706



Exposed parts for bidet spray complete with mixer

Set di parti esterne per Idroscopino igienico con miscelatore

Partie extérieure pour douchette hygiénique avec mitigeur

CODICE / COEFFICIENTE	CODE / COEFFICIENT	COEFFICIENT
CC	EO0706CC	9,8

PACKAGING

L: 370 mm
D: 270 mm
H: 80 mm

3,1 kg

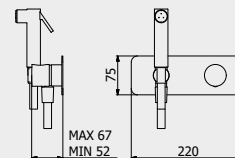

PORTATE | WATER FLOW | DÉBIT D'EAU

1 BAR	2 BAR	3 BAR
2,3 l/m	3,2 l/m	4 l/m

Built-in body to be purchased separately

Corpo incasso da acquistare separatamente

Corps intégré à acheter séparément



CODICE | CODE | CODE

INC206XXXN_19

COEFFICIENTE | COEFFICIENT | COEFFICIENT

2,9

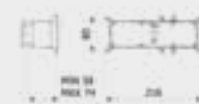

SNATCH / ACCESSORIES COLLECTION

ARTICLE | ARTICOLO | ARTICLE

HJ001

Wall soap-holder

Porta sapone a muro

Porte distributeur de savon encastré

CODICE / COEFFICIENTE | CODE /
COEFFICIENT | CODE / COEFFICIENT

CC	HJ001CC	5,5
SS	HJ001SS	5,7
BO	HJ001BO	5,7
NP	HJ001NP	5,7
CF	HJ001CF	5,7
CS	HJ001CS	5,7
II	HJ001II	5,7
IS	HJ001IS	5,7
RS	HJ001RS	5,7
SR	HJ001SR	5,7
OO	HJ001OO	5,7
OS	HJ001OS	5,7

PACKAGING

L: 150 mm
D: 190 mm
H: 98 mm

0,4 kg

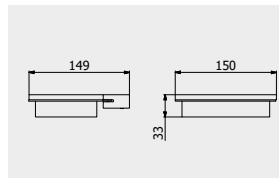

ARTICLE | ARTICOLO | ARTICLE

HJ003

Wall toothbrush holder

Porta spazzolino a muro

Porte brosse à dents encastré

CODICE / COEFFICIENTE | CODE /
COEFFICIENT | CODE / COEFFICIENT

CC	HJ003CC	6,1
SS	HJ003SS	6,3
BO	HJ003BO	6,3
NP	HJ003NP	6,3
CF	HJ003CF	6,3
CS	HJ003CS	6,3
II	HJ003II	6,3
IS	HJ003IS	6,3
RS	HJ003RS	6,3
SR	HJ003SR	6,3
OO	HJ003OO	6,3
OS	HJ003OS	6,3

PACKAGING

L: 175 mm
D: 125 mm
H: 90 mm

0,2 kg

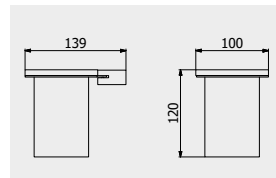

ARTICLE | ARTICOLO | ARTICLE

HJ016

Soap dispenser

Porta sapone da appoggio

Porte distributeur de savon

CODICE / COEFFICIENTE | CODE /
COEFFICIENT | CODE / COEFFICIENT

CC	HJ016CC	2,2
SS	HJ016SS	2,4
BO	HJ016BO	2,4
NP	HJ016NP	2,4
CF	HJ016CF	2,4
CS	HJ016CS	2,4
II	HJ016II	2,4
IS	HJ016IS	2,4
RS	HJ016RS	2,4
SR	HJ016SR	2,4
OO	HJ016OO	2,4
OS	HJ016OS	2,4

PACKAGING

L: 150 mm
D: 190 mm
H: 98 mm

1,1 kg

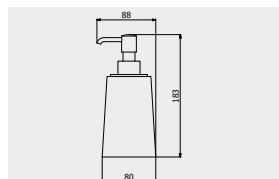

ARTICLE | ARTICOLO | ARTICLE

HJ017

Soap holder

Porta sapone da appoggio

Porte savon

CODICE / COEFFICIENTE | CODE /
COEFFICIENT | CODE / COEFFICIENT

CC	HJ017CC	3,8
----	---------	-----

PACKAGING

L: 175 mm
D: 125 mm
H: 90 mm

0,5 kg

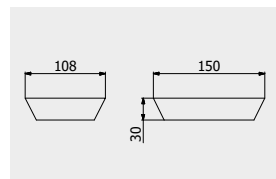

ARTICLE | ARTICOLO | ARTICLE

HJ010

Shelf
Mensola
Etagèr

CODICE / COEFFICIENTE | CODE / COEFFICIENT

CC	HJ010CC	5,1
SS	HJ010SS	5,3
BO	HJ010BO	5,3
NP	HJ010NP	5,3
CF	HJ010CF	5,3
CS	HJ010CS	5,3
II	HJ010II	5,3
IS	HJ010IS	5,3
RS	HJ010RS	5,3
SR	HJ010SR	5,3
OO	HJ010OO	5,3
OS	HJ010OS	5,3

PACKAGING

📦	L: 175 mm	📦	0,4 kg
	D: 125 mm		
	H: 90 mm		

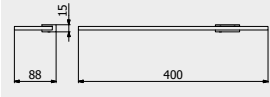

ARTICLE | ARTICOLO | ARTICLE

HJ011

Toilet paper holder
Porta rotolo
Porte rouleaux de toilette

CODICE / COEFFICIENTE | CODE / COEFFICIENT

CC	HJ011CC	3,5
SS	HJ011SS	4,4
BO	HJ011BO	4,4
NP	HJ011NP	4,2
CF	HJ011CF	5,3
CS	HJ011CS	5,7
II	HJ011II	5,3
IS	HJ011IS	5,7
RS	HJ011RS	5,3
SR	HJ011SR	5,7
OO	HJ011OO	5,7
OS	HJ011OS	5,3

PACKAGING

📦	L: 150 mm	📦	0,7 kg
	D: 100 mm		
	H: 70 mm		

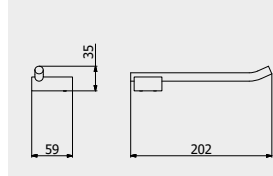

ARTICLE | ARTICOLO | ARTICLE

HJ009

Double robe hook
Doppio appendino a parete
Double cintre

CODICE / COEFFICIENTE | CODE / COEFFICIENT

CC	HJ009CC	3,4
SS	HJ009SS	4,3
BO	HJ009BO	4,3
NP	HJ009NP	4,3
CF	HJ009CF	5,1
CS	HJ009CS	5,4
II	HJ009II	5,4
IS	HJ009IS	5,4
RS	HJ009RS	5,1
SR	HJ009SR	5,4
OO	HJ009OO	5,1
OS	HJ009OS	5,4

PACKAGING

📦	L: 150 mm	📦	0,4 kg
	D: 100 mm		
	H: 70 mm		

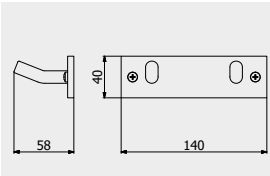

ARTICLE | ARTICOLO | ARTICLE

HJ004

Towel holder
Porta salvietta
Porte-serviette

CODICE / COEFFICIENTE | CODE / COEFFICIENT

CC	HJ004CC	7,5
SS	HJ004SS	9,4
BO	HJ004BO	9,4
NP	HJ004NP	9,4
CF	HJ004CF	11,3
CS	HJ004CS	12,0
II	HJ004II	11,3
IS	HJ004IS	12,0
RS	HJ004RS	11,3
SR	HJ004SR	12,0
OO	HJ004OO	11,3
OS	HJ004OS	12,0

PACKAGING

📦	L: 782 mm	📦	1,9 kg
	D: 135 mm		
	H: 80 mm		

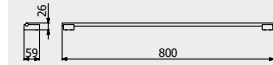
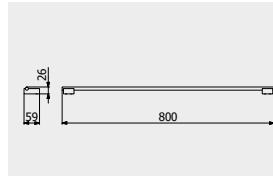

ARTICLE | ARTICOLO | ARTICLE

HJ014

Towel holder
Porta salvietta
Porte-serviette

CODICE / COEFFICIENTE | CODE / COEFFICIENT

CC	HJ014CC	5,1
SS	HJ014SS	6,4
BO	HJ014BO	6,4
NP	HJ014NP	6,4
CF	HJ014CF	7,7
CS	HJ014CS	8,2
II	HJ014II	7,7
IS	HJ014IS	8,2
RS	HJ014RS	7,7
SR	HJ014SR	8,2
OO	HJ014OO	7,7
OS	HJ014OS	8,2

PACKAGING

📦	L: 100 mm	📦	1,1 kg
	D: 100 mm		
	H: 50 mm		

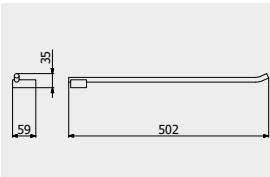

ARTICLE | ARTICOLO | ARTICLE

HJ006

Towel holder
Porta salvietta
Porte-serviette

CODICE / COEFFICIENTE | CODE / COEFFICIENT

CC	HJ006CC	4,9
SS	HJ006SS	6,1
BO	HJ006BO	6,1
NP	HJ006NP	6,1
CF	HJ006CF	7,4
CS	HJ006CS	7,8
II	HJ006II	7,4
IS	HJ006IS	7,8
RS	HJ006RS	7,4
SR	HJ006SR	7,8
OO	HJ006OO	7,4
OS	HJ006OS	7,8

PACKAGING

📦	L: 175 mm	📦	0,9 kg
	D: 125 mm		
	H: 90 mm		

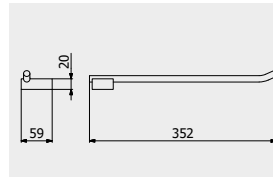

Onlyone

ARTICLE | ARTICOLO | ARTICLE

HJ007

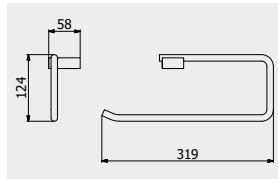

Ring Towel holder

Porta salvietta ad anello

Porte-serviette anneau

CODICE / COEFFICIENTE | CODE /
COEFFICIENT | CODE / COEFFICIENT

CC	HJ007CC	5,0
SS	HJ007SS	6,3
BO	HJ007BO	6,3
NP	HJ007NP	6,3
CF	HJ007CF	7,5
CS	HJ007CS	8,0
II	HJ007II	7,5
IS	HJ007IS	8,0
RS	HJ007RS	7,5
SR	HJ007SR	8,0
OO	HJ007OO	7,5
OS	HJ007OS	8,0

PACKAGING

📦	L: 340 mm	📦	1,9 kg
	D: 180 mm		
	H: 70 mm		

ARTICLE | ARTICOLO | ARTICLE

HJ012

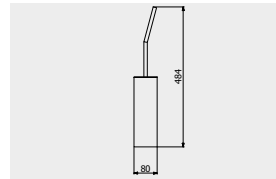

Toilet brush holder

Porta scopino da terra

Porte balayette au sol

CODICE / COEFFICIENTE | CODE /
COEFFICIENT | CODE / COEFFICIENT

CC	HJ012CC	7,8
SS	HJ012SS	9,8
BO	HJ012BO	9,8
NP	HJ012NP	9,8
CF	HJ012CF	11,7
CS	HJ012CS	12,5
II	HJ012II	11,7
IS	HJ012IS	12,5
RS	HJ012RS	11,7
SR	HJ012SR	12,5
OO	HJ012OO	11,7
OS	HJ012OS	12,5

PACKAGING

📦	L: 100 mm	📦	1,8 kg
	D: 100 mm		
	H: 50 mm		

ARTICLE | ARTICOLO | ARTICLE

HJ015

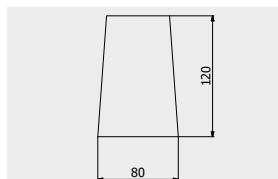

Toothbrush holder

Porta spazzolino

Porte brosse à dents

CODICE / COEFFICIENTE | CODE /
COEFFICIENT | CODE / COEFFICIENT

CC	HJ015CC	2,8
----	---------	-----

PACKAGING

📦	L: 175 mm	📦	0,6 kg
	D: 125 mm		
	H: 90 mm		

ARTICLE | ARTICOLO | ARTICLE

HJ018

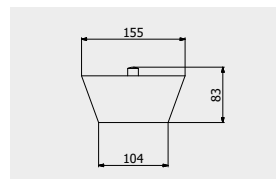

Box

Scatola

Boîte

CODICE / COEFFICIENTE | CODE /
COEFFICIENT | CODE / COEFFICIENT

CC	HJ018CC	4,1
SS	HJ018SS	4,3
BO	HJ018BO	4,3
NP	HJ018NP	4,3
CF	HJ018CF	4,3
CS	HJ018CS	4,3
II	HJ018II	4,3
IS	HJ018IS	4,3
RS	HJ018RS	4,3
SR	HJ018SR	4,3
OO	HJ018OO	4,3
OS	HJ018OS	4,3

PACKAGING

📦	L: 240 mm	📦	1,2 kg
	D: 215 mm		
	H: 110 mm		





RUBACUORI

The sober lines of the square give shape to full and empty volumes.

Le sobrie linee del quadrato danno forma a volumi pieni e vuoti.
Les lignes sobres du carré façonnent des volumes pleins et vides.

A sober and essential line, suitable for modern bathrooms with a strong character. RUBACUORI is able to seduce everyone with its geometric shapes, always in vogue. In addition to the traditional lever, cohesive with the clean forms of the body, two other levers are also available: Bark, which breaks the square lines by adding a small rounded concavity at the end of the lever, and Dr. Jekyll, lighter and more lively, defined only by its outlines.

Una linea sobria ed essenziale, adatta a bagni moderni dal carattere deciso. RUBACUORI è il rubinetto capace di conquistare tutti con le sue forme geometriche sempre in voga. Oltre alla leva tradizionale, coesa alle forme pure del corpo, sono anche disponibili le leve Bark, che rompe le linee squadrate tramite l'aggiunta all'estremità di una piccola insenatura dalla forma arrotondata, e Dr. Jekyll, più leggera e vivace, definita dai soli contorni.

Une ligne sobre et essentielle, adaptée aux salles de bain modernes au caractère résolu. RUBACUORI est le robinet capable de conquérir tout le monde avec ses formes géométriques toujours en vogue. Par delà du levier traditionnel, cohérent avec les formes pures du corps, sont également disponibles les leviers Bark, qui rompt avec les lignes carrées en ajoutant à l'extrémité une petite anse arrondie, et Dr. Jekyll, plus léger et vif, défini seulement par ses contours.



CRYSTAL CLEAR
WATER



TRIPLE LEVERS



LEAD FREE



ZINC FREE





Rubacuori

DESIGN
ANDREA + DAVIDE BREGOLI



- ← DJ200CC
Monohole washbasin mixer
Miscelatore lavabo monoforo
Mitigeur lavabo
- ↓ BK200CC
Monohole washbasin mixer
Miscelatore lavabo monoforo
Mitigeur lavabo
- RU202CC
Tall monohole washbasin mixer
Miscelatore lavabo monoforo alto
Mitigeur lavabo haut





Rubacuori





Rubacuori

← RU299CC
Monohole free-standing washbasin mixer
Miscelatore lavabo da terra
Mitigeur Lavabo Free standing

↑ RU206CC
Wall mounted washbasin mixer
Miscelatore lavabo due fori a parete
Mitigeur lavabo mural

→ RU200CC
Monohole washbasin mixer
Miscelatore lavabo monoforo
Mitigeur lavabo







Rubacuori

↑ DJ206CC
Wall mounted washbasin mixer
Miscelatore lavabo due fori a parete
Mitigeur lavabo mural

← RU201CC
Mini monohole washbasin mixer
Miscelatore lavabo monoforo mini
Mitigeur lavabo mini





Rubacuori

← DJ350CC
Wall mounted shower mixer with shower kit
Doccia esterno a parete con di kit doccia
Mitigeur de douche externe avec flexible et
douchette

↗ RU706CC
Exposed parts for bidet spray
Set di parti esterne per Idroscopino igienico
con miscelatore
Partie extérieure pour douchette hygiénique
avec mitigeur



← **RU314CC**

Three ways wall shower mixer complete with shower kit

Miscelatore doccia a parete con deviatore tre vie e doccino integrato

Mitigeur douche mural trois voies avec inverseur et douchette encastrée

→ **RU250CC**

Wall mounted bath filler complete with hand shower kit

Bordo vasca esterno a parete completo di kit doccia

Mitigeur Bain/douche Mural avec douchette encastrée



LEVER | LEVA | LEVIER



ARTICLE | ARTICOLO | ARTICLE

RU200 / BK200 / DJ200



Monohole washbasin mixer complete with drain

Miscelatore lavabo monoforo completo di scarico automatico

Mitigeur lavabo complet avec bonde automatique

CODE / COEFFICIENT | CODICE / COEFFICIENTE | CODE / COEFFICIENT

	CC	RU200CC	BK200CC	DJ200CC	7,6
	SS	RU200SS	BK200SS	DJ200SS	9,5
	BO	RU200BO	BK200BO	DJ200BO	9,1
	NP	RU200NP	BK200NP	DJ200NP	9,1
	CF	RU200CF	BK200CF	DJ200CF	11,4
	CS	RU200CS	BK200CS	DJ200CS	12,2
	II	RU200II	BK200II	DJ200II	11,4
	IS	RU200IS	BK200IS	DJ200IS	12,2
	RS	RU200RS	BK200RS	DJ200RS	11,4
	SR	RU200SR	BK200SR	DJ200SR	12,2
	OO	RU200OO	BK200OO	DJ200OO	11,4
	OS	RU200OS	BK200OS	DJ200OS	12,2

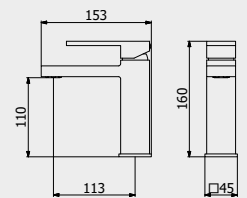

PORTATE | WATER FLOW | DÉBIT D'EAU

1 BAR	2 BAR	3 BAR
7 l/m	9,5 l/m	12 l/m

PACKAGING

	L: 340 mm D: 180 mm H: 70 mm		2,2 kg
--	------------------------------------	--	--------

ARTICLE | ARTICOLO | ARTICLE

RU201



Mini monohole washbasin mixer complete with drain

Miscelatore lavabo monoforo mini completo di scarico automatico

Mitigeur lavabo mini complet avec bonde automatique

CODE / COEFFICIENT | CODICE / COEFFICIENTE | CODE / COEFFICIENT

	CC	RU201CC	6,4
	SS	RU201SS	8,0
	BO	RU201BO	7,7
	NP	RU201NP	7,7
	CF	RU201CF	9,6
	CS	RU201CS	10,2
	II	RU201II	9,6
	IS	RU201IS	10,2
	RS	RU201RS	9,6
	SR	RU201SR	10,2
	OO	RU201OO	9,6
	OS	RU201OS	10,2

PACKAGING

	L: 340 mm D: 180 mm H: 70 mm		1,8 kg
--	------------------------------------	--	--------

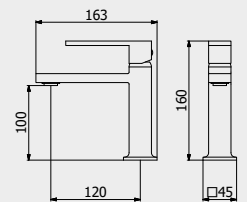

PORTATE | WATER FLOW | DÉBIT D'EAU

1 BAR	2 BAR	3 BAR
7 l/m	9,5 l/m	12 l/m

PACKAGING

	L: 425 mm D: 188 mm H: 98 mm		3,1 kg
--	------------------------------------	--	--------

ARTICLE | ARTICOLO | ARTICLE

RU202 / BK202 / DJ202



Tall monohole washbasin mixer complete with drain

Miscelatore lavabo monoforo alto completo di scarico automatico

Mitigeur lavabo haut complet avec bonde automatique

CODE / COEFFICIENT | CODICE / COEFFICIENTE | CODE / COEFFICIENT

	CC	RU202CC	BK202CC	DJ202CC	10,5
	SS	RU202SS	BK202SS	DJ202SS	13,1
	BO	RU202BO	BK202BO	DJ202BO	12,6
	NP	RU202NP	BK202NP	DJ202NP	12,6
	CF	RU202CF	BK202CF	DJ202CF	15,8
	CS	RU202CS	BK202CS	DJ202CS	16,8
	II	RU202II	BK202II	DJ202II	15,8
	IS	RU202IS	BK202IS	DJ202IS	16,8
	RS	RU202RS	BK202RS	DJ202RS	15,8
	SR	RU202SR	BK202SR	DJ202SR	16,8
	OO	RU202OO	BK202OO	DJ202OO	15,8
	OS	RU202OS	BK202OS	DJ202OS	16,8

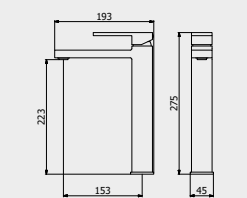

PORTATE | WATER FLOW | DÉBIT D'EAU

1 BAR	2 BAR	3 BAR
7 l/m	9,5 l/m	12 l/m

PACKAGING

	L: 425 mm D: 188 mm H: 98 mm		3,1 kg
--	------------------------------------	--	--------



ARTICLE | ARTICOLO | ARTICLE

RU203



Tall mini monohole washbasin mixer complete with drain
 Miscelatore lavabo monoforo alto mini completo di scarico automatico
 Mitigeur lavabo haut mini complet avec bonde automatique

CODE / COEFFICIENT CODICE / COEFFICIENTE CODE / COEFFICIENT		
CC	RU203CC	8,7
SS	RU203SS	10,9
BO	RU203BO	10,4
NP	RU203NP	10,4
CF	RU203CF	13,1
CS	RU203CS	13,9
II	RU203II	13,1
IS	RU203IS	13,9
RS	RU203RS	13,1
SR	RU203SR	13,9
OO	RU203OO	13,1
OS	RU203OS	13,9

PACKAGING

L: 370 mm
 D: 270 mm
 H: 80 mm
 2,4 kg

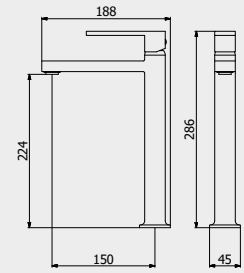

PORTATE | WATER FLOW | DÉBIT D'EAU

1 BAR	2 BAR	3 BAR
7 l/m	9,5 l/m	12 l/m

ARTICLE | ARTICOLO | ARTICLE

RU206 / BK206 / DJ206



Wall mounted washbasin mixer complete with drain
 Miscelatore lavabo due fori a parete completo di scarico automatico
 Mitigeur lavabo Mural complet avec bonde automatique

CODE / COEFFICIENT | CODICE / COEFFICIENTE | CODE / COEFFICIENT

CODE / COEFFICIENT CODICE / COEFFICIENTE CODE / COEFFICIENT				
CC	ERU206CC	EBK206CC	EDJ206CC	8,8
SS	ERU206SS	EBK206SS	EDJ206SS	11,0
BO	ERU206BO	EBK206BO	EDJ206BO	10,6
NP	ERU206NP	EBK206NP	EDJ206NP	10,6
CF	ERU206CF	EBK206CF	EDJ206CF	13,2
CS	ERU206CS	EBK206CS	EDJ206CS	14,1
II	ERU206II	EBK206II	EDJ206II	13,2
IS	ERU206IS	EBK206IS	EDJ206IS	14,1
RS	ERU206RS	EBK206RS	EDJ206RS	13,2
SR	ERU206SR	EBK206SR	EDJ206SR	14,1
OO	ERU206OO	EBK206OO	EDJ206OO	13,2
OS	ERU206OS	EBK206OS	EDJ206OS	14,1

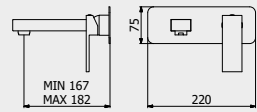

PORTATE | WATER FLOW | DÉBIT D'EAU

1 BAR	2 BAR	3 BAR
8,8 l/m	12,3 l/m	15,2 l/m

PACKAGING

L: 265 mm
 D: 260 mm
 H: 70 mm
 1,7 kg

Rubacuori

Built-in body to be purchased separately

Corpo incasso da acquistare separatamente

Corps intégré à acheter séparément



CODICE | CODE | CODE

INC206XXXN_19

COEFFICIENTE | COEFFICIENT | COEFFICIENT

2,9

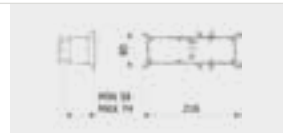

ARTICLE | ARTICOLO | ARTICLE

RU207 / BK207 / DJ207



Wall mounted washbasin mixer with long spout complete with drain
 Miscelatore lavabo due fori a parete completo di scarico automatico
 Mitigeur lavabo Mural complet avec bonde automatique

CODE / COEFFICIENT | CODICE / COEFFICIENTE | CODE / COEFFICIENT

CODE / COEFFICIENT CODICE / COEFFICIENTE CODE / COEFFICIENT				
CC	ERU207CC	EBK207CC	EDJ207CC	9,6
SS	ERU207SS	EBK207SS	EDJ207SS	12,0
BO	ERU207BO	EBK207BO	EDJ207BO	11,5
NP	ERU207NP	EBK207NP	EDJ207NP	11,5
CF	ERU207CF	EBK207CF	EDJ207CF	14,4
CS	ERU207CS	EBK207CS	EDJ207CS	15,4
II	ERU207II	EBK207II	EDJ207II	14,4
IS	ERU207IS	EBK207IS	EDJ207IS	15,4
RS	ERU207RS	EBK207RS	EDJ207RS	14,4
SR	ERU207SR	EBK207SR	EDJ207SR	15,4
OO	ERU207OO	EBK207OO	EDJ207OO	14,4
OS	ERU207OS	EBK207OS	EDJ207OS	15,4

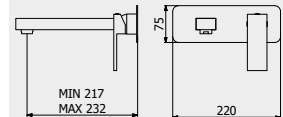

PORTATE | WATER FLOW | DÉBIT D'EAU

1 BAR	2 BAR	3 BAR
8,8 l/m	12,3 l/m	15,2 l/m

PACKAGING

L: 265 mm
 D: 260 mm
 H: 70 mm
 1,7 kg

Built-in body to be purchased separately

Corpo incasso da acquistare separatamente

Corps intégré à acheter séparément



CODICE | CODE | CODE

INC206XXXN_19

COEFFICIENTE | COEFFICIENT | COEFFICIENT

2,9



ARTICLE | ARTICOLO | ARTICLE

RU208 / BK208 / DJ208



Wall mounted washbasin mixer with long spout complete with drain
 Miscelatore lavabo due fori a parete completo di scarico automatico
 Mitigeur lavabo mural complet avec bonde automatique

CODE / COEFFICIENT | CODICE / COEFFICIENTE | CODE / COEFFICIENT

	CC	ERU208CC	EBK208CC	EDJ208CC
	SS	ERU208SS	EBK208SS	EDJ208SS
	BO	ERU208BO	EBK208BO	EDJ208BO
	NP	ERU208NP	EBK208NP	EDJ208NP
	CF	ERU208CF	EBK208CF	EDJ208CF
	CS	ERU208CS	EBK208CS	EDJ208CS
	II	ERU208II	EBK208II	EDJ208II
	IS	ERU208IS	EBK208IS	EDJ208IS
	RS	ERU208RS	EBK208RS	EDJ208RS
	SR	ERU208SR	EBK208SR	EDJ208SR
	OO	ERU208OO	EBK208OO	EDJ208OO
	OS	ERU208OS	EBK208OS	EDJ208OS

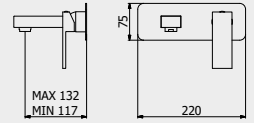

PORTATE | WATER FLOW | DÉBIT D'EAU

1 BAR	2 BAR	3 BAR
8,8 l/m	12,3 l/m	15,2 l/m

PACKAGING

	L: 265 mm D: 260 mm H: 70 mm		1,7 kg
--	------------------------------------	--	--------

! Built-in body to be purchased separately

Corpo incasso da acquistare separatamente

Corps intégré à acheter séparément



CODICE | CODE | CODE

INC206XXXN_19

COEFFICIENTE | COEFFICIENT | COEFFICIENT

2,9

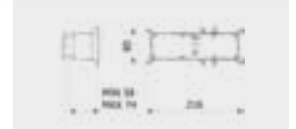

ARTICLE | ARTICOLO | ARTICLE

RU210 / BK210 / DJ210

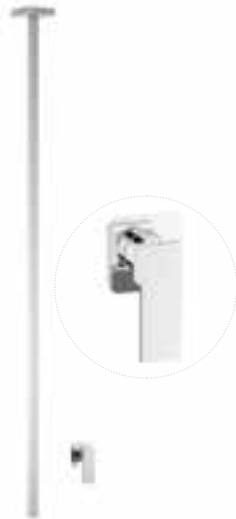

Ceiling spout with wall mounted mixer

Bocca da soffitto con comando remoto ad incasso

Mitigeur lavabo mural avec bec plafond complet avec bonde automatique

CODE / COEFFICIENT | CODICE / COEFFICIENTE | CODE / COEFFICIENT

	CC	ERU210CC	EBK210CC	EDJ210CC
	SS	ERU210SS	EBK210SS	EDJ210SS
	BO	ERU210BO	EBK210BO	EDJ210BO
	NP	ERU210NP	EBK210NP	EDJ210NP

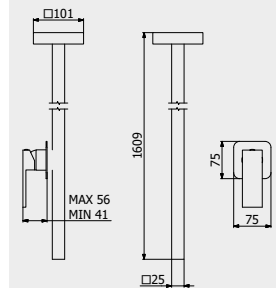

PORTATE | WATER FLOW | DÉBIT D'EAU

1 BAR	2 BAR	3 BAR
4,30 l/m	5,2 l/m	7 l/m

PACKAGING

	L: 150 mm D: 190 mm H: 98 mm		L: 1700 mm Ø: 70 mm
--	------------------------------------	--	------------------------

4,5 kg

! Built-in body to be purchased separately

Corpo incasso da acquistare separatamente

Corps intégré à acheter séparément



CODICE | CODE | CODE

INC300XXXN_19

COEFFICIENTE | COEFFICIENT | COEFFICIENT

1,8



ARTICLE | ARTICOLO | ARTICLE

RU299 / BK299 / DJ299



Monohole free-standing washbasin mixer complete with drain
 Miscelatore lavabo da terra completo di scarico automatico
 Mitigeur lavabo free standing complet avec bonde automatique

CODE / COEFFICIENT | CODICE / COEFFICIENTE | CODE / COEFFICIENT

	CC	SS	BO	NP	CF	CS	II	IS	RS	SR	OO	OS
	ERU299CC	ERU299SS	ERU299BO	ERU299NP	ERU299CF	ERU299CS	ERU299II	ERU299IS	ERU299RS	ERU299SR	ERU299OO	ERU299OS
	EBK299CC	EBK299SS	EBK299BO	EBK299NP	EBK299CF	EBK299CS	EBK299II	EBK299IS	EBK299RS	EBK299SR	EBK299OO	EBK299OS
	EEDJ299CC	EEDJ299SS	EEDJ299BO	EEDJ299NP	EEDJ299CF	EEDJ299CS	EEDJ299II	EEDJ299IS	EEDJ299RS	EEDJ299SR	EEDJ299OO	EEDJ299OS
	35,5	44,4	42,6	42,6	53,3	53,3	53,3	56,8	53,3	56,8	53,3	56,8

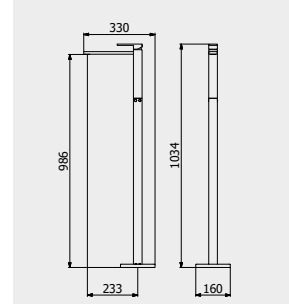

PORTATE | WATER FLOW | DÉBIT D'EAU

1 BAR	2 BAR	3 BAR
6 l/m	7,5 l/m	9 l/m

PACKAGING

L: 1160 mm	⚖️ 13,1 kg
D: 360 mm	
H: 180 mm	

Built-in body to be purchased separately
AVAILABLE FROM JANUARY 2020
 Corpo incasso da acquistare separatamente
DISPONIBILE DA GENNAIO 2020
 Corps intégré à acheter séparément
DISPONIBLE À PARTIR DE JANVIER 2020



CODICE | CODE | CODE

INC399XXXN_19

COEFFICIENTE | COEFFICIENT | COEFFICIENT

2,8

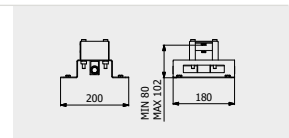

ARTICLE | ARTICOLO | ARTICLE

RU220 / BK220 / DJ220



Monohole bidet mixer complete with drain
 Miscelatore bidet monoforo completo di scarico automatico
 Mitigeur bidet complet avec bonde automatique

CODE / COEFFICIENT | CODICE / COEFFICIENTE | CODE / COEFFICIENT

	CC	SS	BO	NP	CF	CS	II	IS	RS	SR	OO	OS
	RU220CC	RU220SS	RU220BO	RU220NP	RU220CF	RU220CS	RU220II	RU220IS	RU220RS	RU220SR	RU220OO	RU220OS
	BK220CC	BK220SS	BK220BO	BK220NP	BK220CF	BK220CS	BK220II	BK220IS	BK220RS	BK220SR	BK220OO	BK220OS
	DJ220CC	DJ220SS	DJ220BO	DJ220NP	DJ220CF	DJ220CS	DJ220II	DJ220IS	DJ220RS	DJ220SR	DJ220OO	DJ220OS
	7,6	9,5	9,1	9,1	11,4	12,2	11,4	12,2	11,4	12,2	11,4	12,2

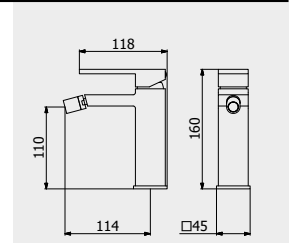

PORTATE | WATER FLOW | DÉBIT D'EAU

1 BAR	2 BAR	3 BAR
7 l/m	9,5 l/m	12 l/m

PACKAGING

L: 340 mm	⚖️ 2,3 kg
D: 180 mm	
H: 70 mm	

Rubacuori

ARTICLE | ARTICOLO | ARTICLE

RU223 / BK223 / DJ223



Mini monohole bidet mixer complete with drain
 Miscelatore bidet monoforo mini completo di scarico automatico
 Mitigeur bidet complet avec bonde automatique

CODE / COEFFICIENT | CODICE / COEFFICIENTE | CODE / COEFFICIENT

	CC	SS	BO	NP	CF	CS	II	IS	RS	SR	OO	OS
	RU223CC	RU223SS	RU223BO	RU223NP	RU223CF	RU223CS	RU223II	RU223IS	RU223RS	RU223SR	RU223OO	RU223OS
	BK223CC	BK223SS	BK223BO	BK223NP	BK223CF	BK223CS	BK223II	BK223IS	BK223RS	BK223SR	BK223OO	BK223OS
	DJ223CC	DJ223SS	DJ223BO	DJ223NP	DJ223CF	DJ223CS	DJ223II	DJ223IS	DJ223RS	DJ223SR	DJ223OO	DJ223OS
	6,4	8,0	7,7	7,7	9,6	10,2	9,6	10,2	9,6	10,2	9,6	10,2

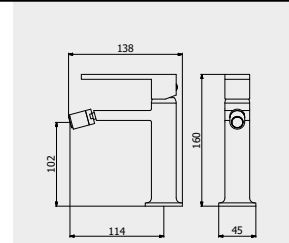

PORTATE | WATER FLOW | DÉBIT D'EAU

1 BAR	2 BAR	3 BAR
5 l/m	7,1 l/m	8,6 l/m

PACKAGING

L: 340 mm	⚖️ 2,3 kg
D: 180 mm	
H: 70 mm	

ARTICLE | ARTICOLO | ARTICLE

RU300 / BK300 / DJ300



Exposed parts for manual wall mixer

Set di parti esterne per miscelatore a parete ad una via

Partie extérieure pour mitigeur encastré à une voie

CODE / COEFFICIENT | CODICE / COEFFICIENTE | CODE / COEFFICIENT

	CC	ERU300CC	EBK300CC	EDJ300CC	4,1
	SS	ERU300SS	EBK300SS	EDJ300SS	5,1
	BO	ERU300BO	EBK300BO	EDJ300BO	4,9
	NP	ERU300NP	EBK300NP	EDJ300NP	4,9
	CF	ERU300CF	EBK300CF	EDJ300CF	6,2
	CS	ERU300CS	EBK300CS	EDJ300CS	6,6
	II	ERU300II	EBK300II	EDJ300II	6,2
	IS	ERU300IS	EBK300IS	EDJ300IS	6,6
	RS	ERU300RS	EBK300RS	EDJ300RS	6,2
	SR	ERU300SR	EBK300SR	EDJ300SR	6,6
	OO	ERU300OO	EBK300OO	EDJ300OO	6,2
	OS	ERU300OS	EBK300OS	EDJ300OS	6,6

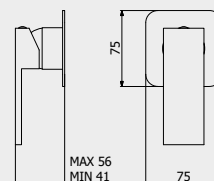

PORTATE | WATER FLOW | DÉBIT D'EAU

1 BAR	2 BAR	3 BAR
11,5 l/m	16,3 l/m	20 l/m

PACKAGING

L: 150 mm
D: 190 mm
H: 98 mm

1,7 kg

Built-in body to be purchased separately

Corpo incasso da acquistare separatamente

Corps intégré à acheter séparément



CODICE | CODE | CODE

INC300XXXN_19

COEFFICIENTE | COEFFICIENT | COEFFICIENT

1,8

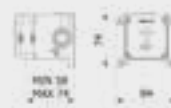

ARTICLE | ARTICOLO | ARTICLE

RU310 / BK310 / DJ310



Exposed parts for manual wall mixer with two ways diverter

Miscelatore doccia a parete con deviatore due vie

Mitigeur douche mural deux voies avec inverseur

CODE / COEFFICIENT | CODICE / COEFFICIENTE | CODE / COEFFICIENT

	CC	ERU310CC	EBK310CC	EDJ310CC	6,1
	SS	ERU310SS	EBK310SS	EDJ310SS	7,6
	BO	ERU310BO	EBK310BO	EDJ310BO	7,3
	NP	ERU310NP	EBK310NP	EDJ310NP	7,3
	CF	ERU310CF	EBK310CF	EDJ310CF	9,2
	CS	ERU310CS	EBK310CS	EDJ310CS	9,8
	II	ERU310II	EBK310II	EDJ310II	9,2
	IS	ERU310IS	EBK310IS	EDJ310IS	9,8
	RS	ERU310RS	EBK310RS	EDJ310RS	9,2
	SR	ERU310SR	EBK310SR	EDJ310SR	9,8
	OO	ERU310OO	EBK310OO	EDJ310OO	9,2
	OS	ERU310OS	EBK310OS	EDJ310OS	9,8

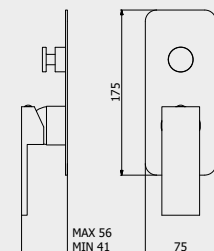

PORTATE | WATER FLOW | DÉBIT D'EAU

1 BAR	2 BAR	3 BAR
9,2 l/m	12,8 l/m	16 l/m

PACKAGING

L: 150 mm
D: 190 mm
H: 98 mm

1,7 kg

Built-in body to be purchased separately

Corpo incasso da acquistare separatamente

Corps intégré à acheter séparément



CODICE | CODE | CODE

INC310XXXN_19

COEFFICIENTE | COEFFICIENT | COEFFICIENT

3,3



ARTICLE | ARTICOLO | ARTICLE

RU312 / BK312 / DJ312



Exposed parts for manual wall mixer with three ways diverter
Set di parti esterne per miscelatore a parete a tre vie
Mitigeur douche mural trois voies avec inverseur

CODE / COEFFICIENT | CODICE / COEFFICIENTE | CODE / COEFFICIENT

	ERU312CC	EBK312CC	EDJ312CC	7,4
	ERU312SS	EBK312SS	EDJ312SS	9,3
	ERU312BO	EBK312BO	EDJ312BO	8,9
	ERU312NP	EBK312NP	EDJ312NP	8,9
	ERU312CF	EBK312CF	EDJ312CF	11,1
	ERU312CS	EBK312CS	EDJ312CS	11,8
	ERU312II	EBK312II	EDJ312II	11,1
	ERU312IS	EBK312IS	EDJ312IS	11,8
	ERU312RS	EBK312RS	EDJ312RS	11,1
	ERU312SR	EBK312SR	EDJ312SR	11,8
	ERU312OO	EBK312OO	EDJ312OO	11,1
	ERU312OS	EBK312OS	EDJ312OS	11,8

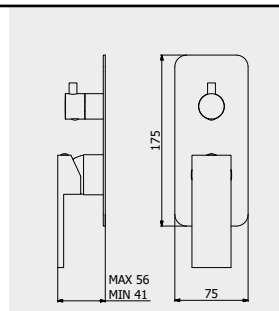

PORTATE | WATER FLOW | DÉBIT D'EAU

1 BAR	2 BAR	3 BAR
8,3 l/m	11,7 l/m	14,3 l/m

PACKAGING

L: 150 mm
D: 190 mm
H: 98 mm 1,7 kg

Built-in body to be purchased separately

Corpo incasso da acquistare separatamente
Corps intégré à acheter séparément



CODICE | CODE | CODE

INC312XXXN_19

COEFFICIENTE | COEFFICIENT | COEFFICIENT

3,3

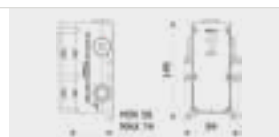

ARTICLE | ARTICOLO | ARTICLE

RU313 / BK313 / DJ313



Exposed parts for manual wall mixer with 2 ways with shower kit
Set di parti esterne per miscelatore a parete a due vie completo di kit doccia
Partie extérieure pour mitigeur encastré à deux voies avec douchette

CODE / COEFFICIENT | CODICE / COEFFICIENTE | CODE / COEFFICIENT

	ERU313CC	EBK313CC	EDJ313CC	10,1
	ERU313SS	EBK313SS	EDJ313SS	12,6
	ERU313BO	EBK313BO	EDJ313BO	12,1
	ERU313NP	EBK313NP	EDJ313NP	12,1
	ERU313CF	EBK313CF	EDJ313CF	15,2
	ERU313CS	EBK313CS	EDJ313CS	16,2
	ERU313II	EBK313II	EDJ313II	15,2
	ERU313IS	EBK313IS	EDJ313IS	16,2
	ERU313RS	EBK313RS	EDJ313RS	15,2
	ERU313SR	EBK313SR	EDJ313SR	16,2
	ERU313OO	EBK313OO	EDJ313OO	15,2
	ERU313OS	EBK313OS	EDJ313OS	16,2

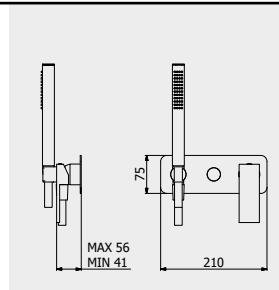

PORTATE | WATER FLOW | DÉBIT D'EAU

1 BAR	2 BAR	3 BAR
10 l/m	14,1 l/m	17,2 l/m

PACKAGING

L: 370 mm
D: 270 mm
H: 98 mm 2,1 kg

Built-in body to be purchased separately

Corpo incasso da acquistare separatamente
Corps intégré à acheter séparément



CODICE | CODE | CODE

INC313XXXN_19

COEFFICIENTE | COEFFICIENT | COEFFICIENT

3,6



ARTICLE | ARTICOLO | ARTICLE

RU314 / BK314 / DJ314



Exposed parts for manual wall mixer with 3 ways with shower kit
Set di parti esterne per miscelatore a parete a tre vie completo di kit doccia
Partie extérieure pour mitigeur encastré à trois voies avec douchette

CODE / COEFFICIENT | CODICE / COEFFICIENTE | CODE / COEFFICIENT

	ERU314CC	EBK314CC	EDJ314CC	11,4
	ERU314SS	EBK314SS	EDJ314SS	14,3
	ERU314BO	EBK314BO	EDJ314BO	13,7
	ERU314NP	EBK314NP	EDJ314NP	13,7
	ERU314CF	EBK314CF	EDJ314CF	17,1
	ERU314CS	EBK314CS	EDJ314CS	18,2
	ERU314II	EBK314II	EDJ314II	17,1
	ERU314IS	EBK314IS	EDJ314IS	18,2
	ERU314RS	EBK314RS	EDJ314RS	17,1
	ERU314SR	EBK314SR	EDJ314SR	18,2
	ERU314OO	EBK314OO	EDJ314OO	17,1
	ERU314OS	EBK314OS	EDJ314OS	18,2

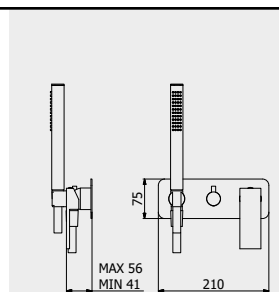

PORTATE | WATER FLOW | DÉBIT D'EAU

1 BAR	2 BAR	3 BAR
8,3 l/m	11,7 l/m	14,3 l/m

PACKAGING

L: 370 mm
D: 270 mm
H: 98 mm 2,1 kg

Built-in body to be purchased separately

Corpo incasso da acquistare separatamente
Corps intégré à acheter séparément



CODICE | CODE | CODE

INC314XXXN_19

COEFFICIENTE | COEFFICIENT | COEFFICIENT

3,7

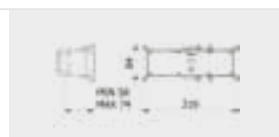

ARTICLE | ARTICOLO | ARTICLE

RU250 / BK250 / DJ250



Wall mounted bath filler complete with hand shower kit
Bordo vasca esterno a parete completo di kit doccia
Mitigeur Bain/douche Mural avec douchette encastrée

CODE / COEFFICIENT | CODICE / COEFFICIENTE | CODE / COEFFICIENT

	CC	RU250CC	BK250CC	DJ250CC
14,4				
	SS	RU250SS	BK250SS	DJ250SS
18,0				
	BO	RU250BO	BK250BO	DJ250BO
17,3				
	NP	RU250NP	BK250NP	DJ250NP
17,3				
	CF	RU250CF	BK250CF	DJ250CF
21,6				
	CS	RU250CS	BK250CS	DJ250CS
23				
	II	RU250II	BK250II	DJ250II
21,6				
	IS	RU250IS	BK250IS	DJ250IS
23				
	RS	RU250RS	BK250RS	DJ250RS
21,6				
	SR	RU250SR	BK250SR	DJ250SR
23				
	OO	RU250OO	BK250OO	DJ250OO
21,6				
	OS	RU250OS	BK250OS	DJ250OS
23				

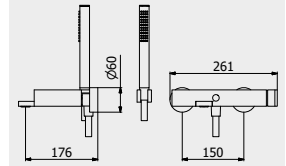

PORTATE | WATER FLOW | DÉBIT D'EAU

1 BAR	2 BAR	3 BAR
10 l/m	14 l/m	17 l/m

PACKAGING

L: 370 mm
D: 270 mm
H: 80 mm

4,6 kg

ARTICLE | ARTICOLO | ARTICLE

RU350 / BK350 / DJ350



Wall mounted shower mixer with shower kit

Doccia esterno a parete completo di kit doccia
Mitigeur de douche externe avec flexible et douchette

CODE / COEFFICIENT | CODICE / COEFFICIENTE | CODE / COEFFICIENT

	CC	RU350CC	BK350CC	DJ350CC
13,7				
	SS	RU350SS	BK350SS	DJ350SS
17,1				
	BO	RU350BO	BK350BO	DJ350BO
16,4				
	NP	RU350NP	BK350NP	DJ350NP
16,4				
	CF	RU350CF	BK350CF	DJ350CF
20,6				
	CS	RU350CS	BK350CS	DJ350CS
21,9				
	II	RU350II	BK350II	DJ350II
20,6				
	IS	RU350IS	BK350IS	DJ350IS
21,9				
	RS	RU350RS	BK350RS	DJ350RS
20,6				
	SR	RU350SR	BK350SR	DJ350SR
21,9				
	OO	RU350OO	BK350OO	DJ350OO
20,6				
	OS	RU350OS	BK350OS	DJ350OS
21,9				

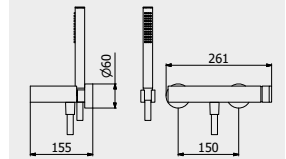

PORTATE | WATER FLOW | DÉBIT D'EAU

1 BAR	2 BAR	3 BAR
12 l/m	17 l/m	22 l/m

PACKAGING

L: 370 mm
D: 270 mm
H: 80 mm

4,2 kg

ARTICLE | ARTICOLO | ARTICLE

RU399 / BK399 / DJ399



Free-standing bath filler with shower kit

Bordo vasca da terra con kit doccia
Bain douche complet alimentation au sol

CODE / COEFFICIENT | CODICE / COEFFICIENTE | CODE / COEFFICIENT

	CC	ERU399CC	EBK399CC	EDJ399CC
26,3				
	SS	ERU399SS	EBK399SS	EDJ399SS
32,9				
	BO	ERU399BO	EBK399BO	EDJ399BO
31,6				
	NP	ERU399NP	EBK399NP	EDJ399NP
31,6				
	CF	ERU399CF	EBK399CF	EDJ399CF
39,5				
	CS	ERU399CS	EBK399CS	EDJ399CS
42,1				
	II	ERU399II	EBK399II	EDJ399II
39,5				
	IS	ERU399IS	EBK399IS	EDJ399IS
42,1				
	RS	ERU399RS	EBK399RS	EDJ399RS
39,5				
	SR	ERU399SR	EBK399SR	EDJ399SR
42,1				
	OO	ERU399OO	EBK399OO	EDJ399OO
39,5				
	OS	ERU399OS	EBK399OS	EDJ399OS
42,1				

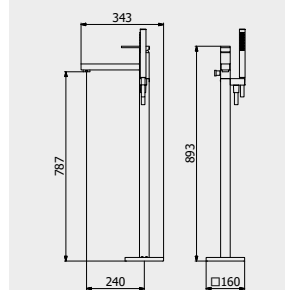

PORTATE | WATER FLOW | DÉBIT D'EAU

1 BAR	2 BAR	3 BAR
12 l/m	17 l/m	21 l/m

PACKAGING

L: 1110 mm
D: 400 mm
H: 170 mm

14 kg

Built-in body to be purchased separately
AVAILABLE FROM JANUARY 2020

Corpo incasso da acquistare separatamente
DISPONIBILE DA GENNAIO 2020

Corps intégré à acheter séparément
DISPONIBLE À PARTIR DE JANVIER 2020



CODICE | CODE | CODE

INC399XXXN_19

COEFFICIENTE | COEFFICIENT | COEFFICIENT

2,8

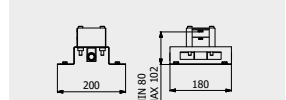

ARTICLE | ARTICOLO | ARTICLE

RU318



Built-in wall mounted waterfall spout
 Cascata a parete con erogazione a lama esterna
 Cascade murale avc bec externe



CODE / COEFFICIENT	CODICE / COEFFICIENTE	
CC	RU318CC	22,9
SS	RU318SS	28,6
BO	RU318BO	27,5
NP	RU318NP	27,5
CF	RU318CF	34,4
CS	RU318CS	36,6
II	RU318II	34,4
IS	RU318IS	36,6
RS	RU318RS	34,4
SR	RU318SR	36,6
OO	RU318OO	34,4
OS	RU318OS	36,6

PACKAGING

L: 340 mm
 D: 180 mm
 H: 70 mm
 4,0 kg

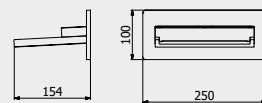

PORTATE | WATER FLOW | DÉBIT D'EAU

1 BAR	2 BAR	3 BAR
13 l/m	17 l/m	20 l/m

ARTICLE | ARTICOLO | ARTICLE

RU319



Wall mounted waterfall
 Cascata a parete con erogazione diretta
 Cascade murale



CODE / COEFFICIENT	CODICE / COEFFICIENTE	
CC	RU319CC	12,8
SS	RU319SS	16,0
BO	RU319BO	15,4
NP	RU319NP	15,4
CF	RU319CF	19,2
CS	RU319CS	20,5
II	RU319II	19,2
IS	RU319IS	20,5
RS	RU319RS	19,2
SR	RU319SR	20,5
OO	RU319OO	19,2
OS	RU319OS	20,5

PACKAGING

L: 340 mm
 D: 180 mm
 H: 70 mm
 3,1 kg

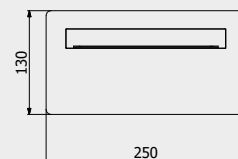

PORTATE | WATER FLOW | DÉBIT D'EAU

1 BAR	2 BAR	3 BAR
13 l/m	17 l/m	20 l/m

Rubacuori

ARTICLE | ARTICOLO | ARTICLE

RU320



Wall mounted spout
 Bocca d'erogazione a parete
 Bec de remplissage mural



CODE / COEFFICIENT	CODICE / COEFFICIENTE	
CC	RU320CC	2,1
SS	RU320SS	2,6
BO	RU320BO	2,5
NP	RU320NP	2,5
CF	RU320CF	3,2
CS	RU320CS	3,4
II	RU320II	3,2
IS	RU320IS	3,4
RS	RU320RS	3,2
SR	RU320SR	3,4
OO	RU320OO	3,2
OS	RU320OS	3,4

PACKAGING

L: 210 mm
 D: 130 mm
 H: 70 mm
 1,1 kg

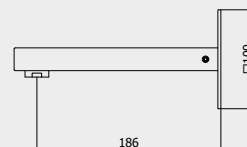

PORTATE | WATER FLOW | DÉBIT D'EAU

1 BAR	2 BAR	3 BAR
10 l/m	14 l/m	17 l/m

ARTICLE | ARTICOLO | ARTICLE

RU321



Short wall mounted spout
 Bocca d'erogazione corta a parete
 Bec de remplissage mural court



CODE / COEFFICIENT	CODICE / COEFFICIENTE	
CC	RU321CC	2,5
SS	RU321SS	3,1
BO	RU321BO	3,0
NP	RU321NP	3,0
CF	RU321CF	3,8
CS	RU321CS	4,0
II	RU321II	3,8
IS	RU321IS	4,0
RS	RU321RS	3,8
SR	RU321SR	4,0
OO	RU321OO	3,8
OS	RU321OS	4,0

PACKAGING

L: 210 mm
 D: 130 mm
 H: 70 mm
 1,0 kg

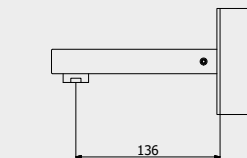

PORTATE | WATER FLOW | DÉBIT D'EAU

1 BAR	2 BAR	3 BAR
10 l/m	14 l/m	17 l/m

ARTICLE | ARTICOLO | ARTICLE

RU322



Long wall mounted spout

Bocca d'erogazione lunga a parete

Bec de remplissage mural long

CODE / COEFFICIENT | CODICE /
COEFFICIENTE | CODE / COEFFICIENT

● CC	RU322CC	3,0
● SS	RU322SS	3,8
● BO	RU322BO	3,6
● NP	RU322NP	3,6
● CF	RU322CF	4,5
● CS	RU322CS	4,8
● II	RU322II	4,5
● IS	RU322IS	4,8
● RS	RU322RS	4,5
● SR	RU322SR	4,8
● OO	RU322OO	4,5
● OS	RU322OS	4,8

PACKAGING

L: 210 mm
D: 130 mm
H: 70 mm

1,2 kg

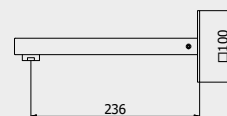

PORTATE | WATER FLOW | DÉBIT D'EAU

1 BAR	2 BAR	3 BAR
10 l/m	14 l/m	17 l/m

ARTICLE | ARTICOLO | ARTICLE

RU800



Rubacuori shower column

Colonna doccia Rubacuori

Colonne de douche Rubacuori

CODE / COEFFICIENT | CODICE /
COEFFICIENTE | CODE / COEFFICIENT

● CC	RU800CC	29,4
------	---------	------

PACKAGING

L: 1185 mm
D: 415 mm
H: 277 mm

4 kg

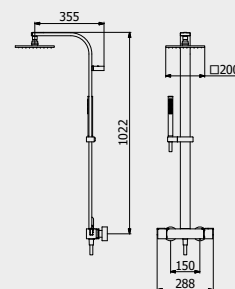

PORTATE | WATER FLOW | DÉBIT D'EAU

1 BAR	2 BAR	3 BAR
6,5 l/m	9,7 l/m	12,1 l/m

ARTICLE | ARTICOLO | ARTICLE

RU706



Exposed parts for bidet spray complete with mixer

Set di parti esterne per Idroscopino igienico con miscelatore

Partie extérieure pour douchette hygiénique avec mitigeur

CODE / COEFFICIENT | CODICE / COEFFICIENTE | CODE / COEFFICIENT

● CC	ERU706CC	EBK706CC	EDJ706CC	9,8
● SS	ERU706SS	EBK706SS	EDJ706SS	12,3
● BO	ERU706BO	EBK706BO	EDJ706BO	11,8
● NP	ERU706NP	EBK706NP	EDJ706NP	11,8
● CF	ERU706CF	EBK706CF	EDJ706CF	14,7
● CS	ERU706CS	EBK706CS	EDJ706CS	15,7
● II	ERU706II	EBK706II	EDJ706II	14,7
● IS	ERU706IS	EBK706IS	EDJ706IS	15,7
● RS	ERU706RS	EBK706RS	EDJ706RS	14,7
● SR	ERU706SR	EBK706SR	EDJ706SR	15,7
● OO	ERU706OO	EBK706OO	EDJ706OO	14,7
● OS	ERU706OS	EBK706OS	EDJ706OS	15,7

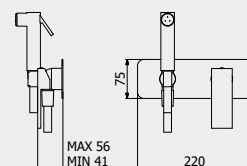

PORTATE | WATER FLOW | DÉBIT D'EAU

1 BAR	2 BAR	3 BAR
2,3 l/m	3,2 l/m	4 l/m

PACKAGING

L: 370 mm
D: 270 mm
H: 80 mm

3,1 kg

Built-in body to be purchased separately

Corpo incasso da acquistare separatamente

Corps intégré à acheter séparément



CODICE | CODE | CODE

INC206XXXN_19

COEFFICIENTE | COEFFICIENT | COEFFICIENT

2,9

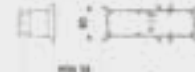

MODERNA / ACCESSORIES COLLECTION

ARTICLE | ARTICOLO | ARTICLE

MO001

Wall soap-holder

Porta sapone a muro
Porte distributeur de savon encastré

CODE / COEFFICIENT | CODICE /
COEFFICIENTE | CODE / COEFFICIENT

CC MO001CC 1,5

PACKAGING

L: 110 mm
D: 130 mm
H: 50 mm

0,4 kg

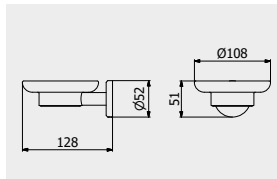

ARTICLE | ARTICOLO | ARTICLE

MO002

Wall soap dispenser holder

Porta dispenser sapone liquido a parete
Porte distributeur de savon en verre gravé

CODE / COEFFICIENT | CODICE /
COEFFICIENTE | CODE / COEFFICIENT

CC MO002CC 2,3

PACKAGING

L: 80 mm
D: 130 mm
H: 180 mm

0,1 kg

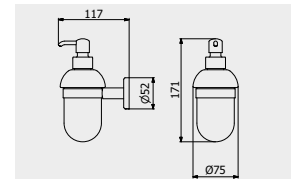

ARTICLE | ARTICOLO | ARTICLE

MO003

Wall toothbrush holder

Bicchiera porta spazzolino a parete
Porte-verre en verre gravé

CODE / COEFFICIENT | CODICE /
COEFFICIENTE | CODE / COEFFICIENT

CC MO003CC 1,5

PACKAGING

L: 70 mm
D: 110 mm
H: 100 mm

0,4 kg

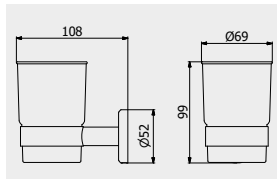

ARTICLE | ARTICOLO | ARTICLE

MO004

Towel holder

Porta salvietta
Porte-serviette

CODE / COEFFICIENT | CODICE /
COEFFICIENTE | CODE / COEFFICIENT

CC MO004CC 2,4

PACKAGING

L: 650 mm
D: 70 mm
H: 50 mm

0,5 kg

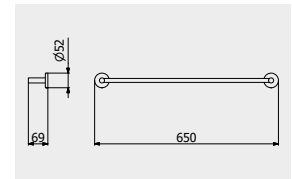

ARTICLE | ARTICOLO | ARTICLE

MO014

Towel holder

Porta salvietta
Porte-serviette

CODE / COEFFICIENT | CODICE /
COEFFICIENTE | CODE / COEFFICIENT

CC MO014CC 2,2

PACKAGING

L: 500 mm
D: 70 mm
H: 50 mm

0,5 kg

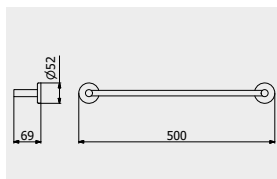

ARTICLE | ARTICOLO | ARTICLE

MO006

Towel holder

Porta salvietta
Porte-serviette

CODE / COEFFICIENT | CODICE /
COEFFICIENTE | CODE / COEFFICIENT

CC MO006CC 2,1

PACKAGING

L: 350 mm
D: 70 mm
H: 50 mm

0,4 kg

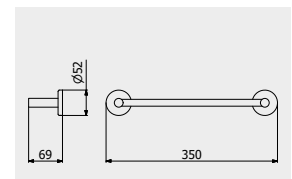

Rubacuori

ARTICLE | ARTICOLO | ARTICLE

M0007



Ring Towel holder

Porta salvietta ad anello

Porte-serviette anneau

CODE / COEFFICIENT | CODICE /
COEFFICIENTE | CODE / COEFFICIENT

CC M0007CC 1,6

PACKAGING

L: 180 mm
D: 70 mm
H: 200 mm

0,8 kg

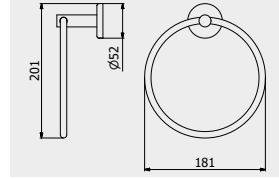

ARTICLE | ARTICOLO | ARTICLE

M0008



Robe Hook

Appendino a parete

Cintre

CODE / COEFFICIENT | CODICE /
COEFFICIENTE | CODE / COEFFICIENT

CC M0008CC 0,9

PACKAGING

L: 50 mm
D: 50 mm
H: 50 mm

0,3 kg

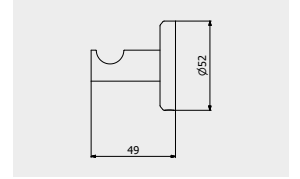

ARTICLE | ARTICOLO | ARTICLE

M0009



Double robe hook

Doppio appendino a parete

Double cintre

CODE / COEFFICIENT | CODICE /
COEFFICIENTE | CODE / COEFFICIENT

CC M0009CC 1,4

PACKAGING

L: 70 mm
D: 70 mm
H: 50 mm

0,1 kg

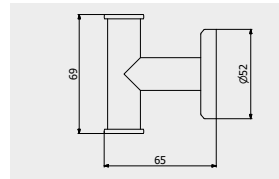

ARTICLE | ARTICOLO | ARTICLE

M0010



Shelf

Mensola

Etagère

CODE / COEFFICIENT | CODICE /
COEFFICIENTE | CODE / COEFFICIENT

CC M0010CC 3,0

PACKAGING

L: 600 mm
D: 140 mm
H: 50 mm

0,3 kg

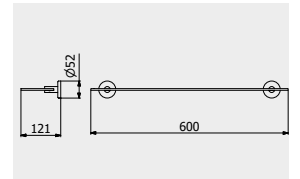

ARTICLE | ARTICOLO | ARTICLE

M0005



Swiveable towel holder

Porta salvietta doppio

Porte-serviette noeud

CODE / COEFFICIENT | CODICE /
COEFFICIENTE | CODE / COEFFICIENT

CC M0005CC 3,5

PACKAGING

L: 430 mm
D: 70 mm
H: 50 mm

0,5 kg

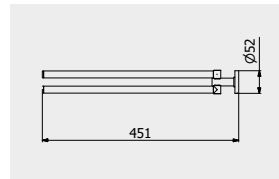

ARTICLE | ARTICOLO | ARTICLE

M0011



Toilet paper holder

Porta rotolo

Porte rouleaux de toilette

CODE / COEFFICIENT | CODICE /
COEFFICIENTE | CODE / COEFFICIENT

CC M0011CC 1,4

PACKAGING

L: 150 mm
D: 70 mm
H: 50 mm

0,2 kg

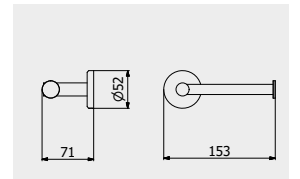

ARTICLE | ARTICOLO | ARTICLE

M0012



Toilet brush holder

Porta scopino da terra

Porte balayette au sol

CODE / COEFFICIENT | CODICE /
COEFFICIENTE | CODE / COEFFICIENT

CC M0012CC 2,5

PACKAGING

L: 80 mm
D: 80 mm
H: 380 mm

0,7 kg

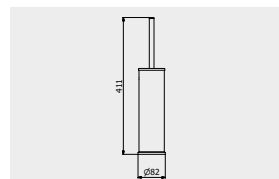

ARTICLE | ARTICOLO | ARTICLE

M0013



Wall toilet brush holder

Porta scopino da parete

Porte balayette

CODE / COEFFICIENT | CODICE /
COEFFICIENTE | CODE / COEFFICIENT

CC M0013CC 2,9

PACKAGING

L: 80 mm
D: 80 mm
H: 380 mm

0,7 kg

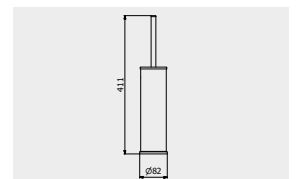

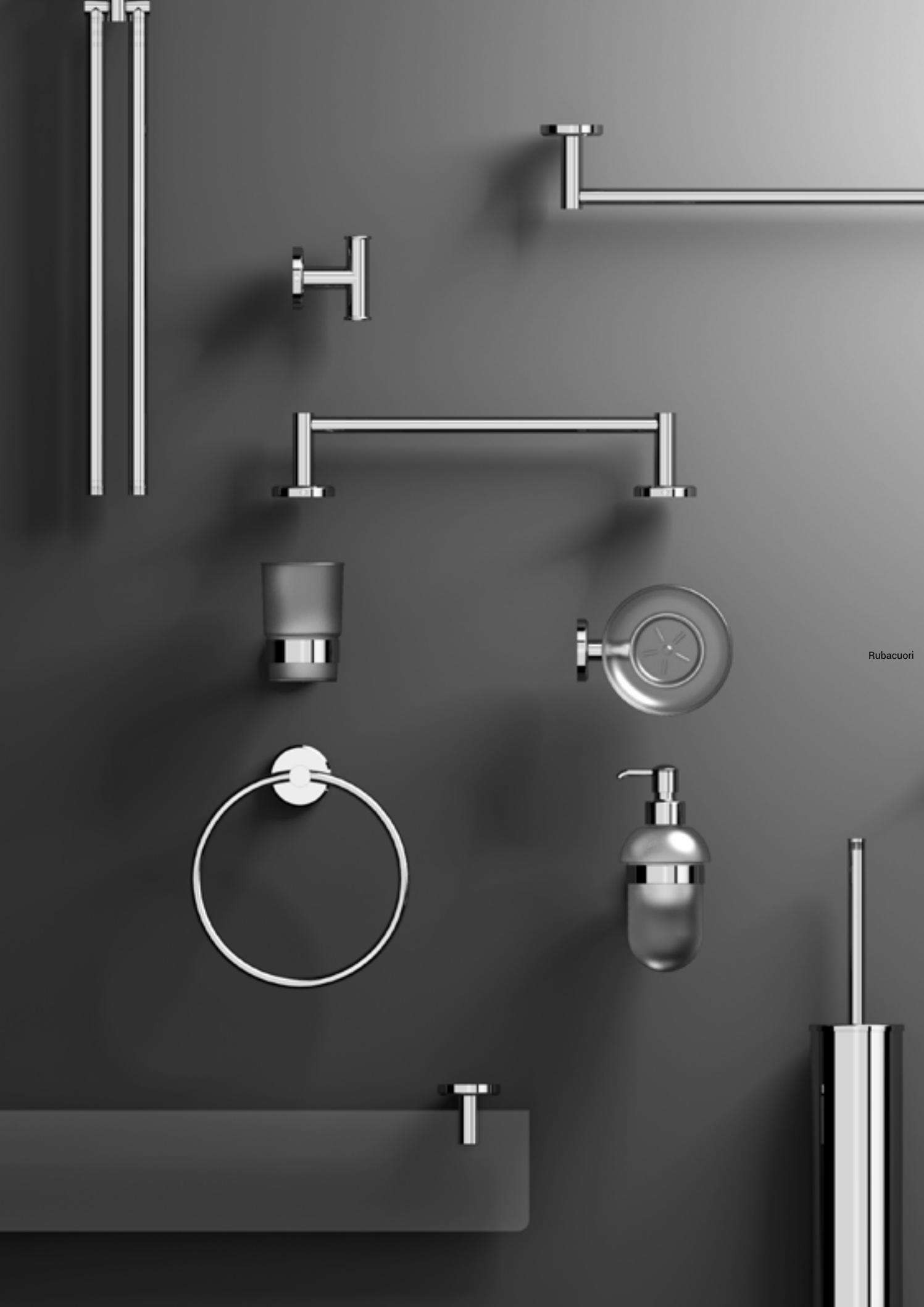

Rubacuori

HEY JOE!

It excites the eye and the imagination just like the Jimi Hendrix's guitar solos.

Stuzzica l'occhio e la fantasia proprio come gli assoli di chitarra di Jimi Hendrix.

Il excite à la fois le regard et l'imagination, exactement comme les solos de Jimi Hendrix.

Iridescent to the touch and built on the contrast between a strongly characterized body and a sinuous and thin lever, HEY JOE! is a versatile collection, with a strong and elusive line, which excites the eye and arouses the imagination just like the powerful and ephemeral Jimi Hendrix's guitar solos, to whom the collection pays tribute.

Cangiante al tatto e costruita sul contrasto tra una base dal carattere deciso e una leva sinuosa e sottile, HEY JOE! è una collezione versatile, dal tratto forte ed elusivo, che stuzzica l'occhio e la fantasia proprio come gli assoli di chitarra di Jimi Hendrix, potenti ed effimeri, a cui il nome della serie rende omaggio.

Changeant au toucher et construit à partir du contraste entre une base au caractère fort et un levier sinueux et fin, HEY JOE! est une collection polyvalente, avec une ligne forte et évasive, qui excite à la fois le regard et l'imagination, exactement comme les solos de guitare puissants et éphémères de Jimi Hendrix, à qui le nom de la collection rend hommage.



KITCHEN
AVAILABLE



CRYSTAL CLEAR
WATER



LEAD FREE



ZINC FREE





HeyJoe

DESIGN
MAURIZIO DURANTI

**“ At 3 o’ clock in the night,
even the true things
seem false and ephemeral.
I was thinking about this,
while Hendrix was throwing
the guitar solos of Hey Joe,
and it was as if he was
saying, without arrogance:
from now on this is the way
to play!**

Alle 3 del mattino, persino le cose vere sembrano false ed effimere. Stavo pensando a questo quando Hendrix stava suonando la chitarra nell'assolo di Hey Joe, ed era come se lo stesse dicendo, senza arroganza: d'ora in poi questo è il modo di suonare!

À 3 heures du matin, même les choses les plus vraies paraissent fausses et éphémères. Je pensais à cela, pendant que Hendrix lançait sa guitare dans les solos de Hey Joe, et c'était comme s'il disait, sans arrogance: à partir de ce moment, il faut jouer comme ça!

”

Maurizio Duranti design for HEY JOE!



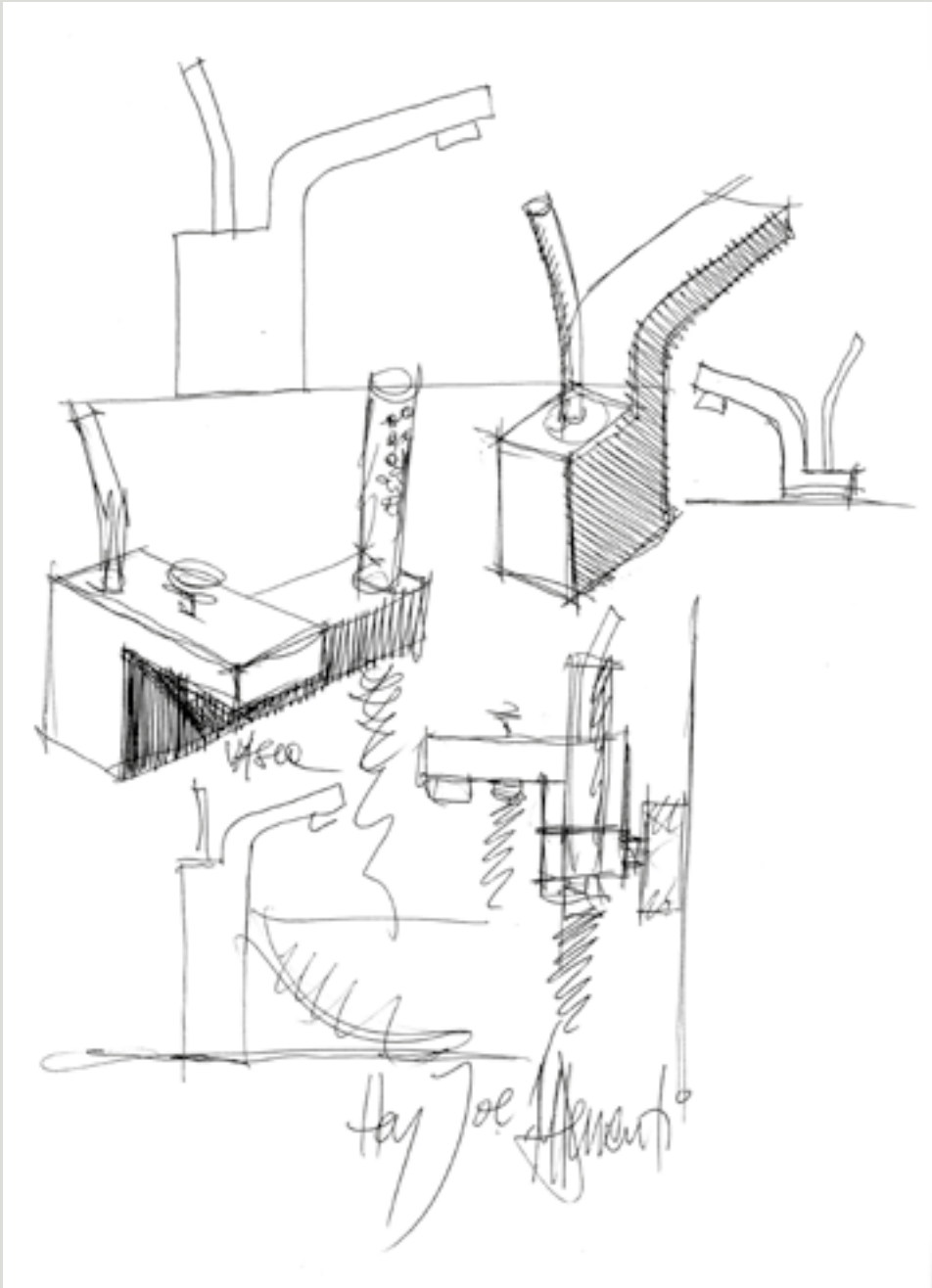

HeyJoe





- ← HJ202NP
Tall monohole washbasin mixer
Miscelatore lavabo monoforo alto
Mitigeur lavabo haut
- ↑ HJ206CC
Wall mounted washbasin mixer
Miscelatore lavabo due fori a parete
Mitigeur lavabo encastré
- HJ200CC
Monohole washbasin mixer
Miscelatore lavabo monoforo
Mitigeur lavabo

HeyJoe







← HJ350CC
Wall mounted shower mixer with shower kit
Doccia esterno a parete con kit doccia
Mitigeur de douche externe avec flexible et
douchette

→ HJ320CC
Wall mounted spout
Bocca d'erogazione a parete
Bec de remplissage mural



HeyJoe



↖ **K2314CC**
Exposed parts for manual wall mixer with three ways with shower kit
 Set di parti esterne per miscelatore a parete a tre vie completo di kit doccia
 Partie extérieure pour mitigeur encastré à trois voies avec douchette

→ **HJ800CC**
Shower column with mixer and shower kit
 Colonna doccia con miscelatore e e kit doccia
 Colonne de douche avec mitigeur et kit douche





↖ HJ399CC
← Free-standing bath filler with shower kit
Bordo vasca da terra con kit doccia
Bain douche complet alimentation au sol

ARTICLE | ARTICOLO | ARTICLE

HJ200



Monohole washbasin mixer complete with drain
 Miscelatore lavabo monoforo completo di scarico automatico
 Mitigeur Lavabo complet avec bonde automatique

CODICE / COEFFICIENTE CODE / COEFFICIENT	
● CC	HJ200CC 7,5
● SS	HJ200SS 9,4
● NP	HJ200NP 9,0

PACKAGING
 L: 240 mm
 D: 215 mm
 H: 110 mm
 2,9 kg

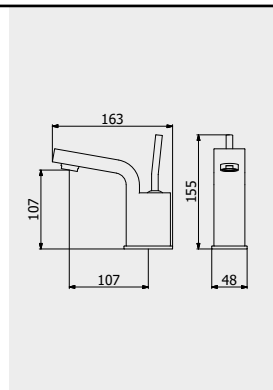

PORTATE | WATER FLOW | DÉBIT D'EAU

1 BAR	2 BAR	3 BAR
14,4 l/m	20,6 l/m	25,4 l/m

ARTICLE | ARTICOLO | ARTICLE

HJ204



Mid-size monohole washbasin mixer complete with drain
 Miscelatore lavabo monoforo medio completo di scarico automatico
 Mitigeur Lavabo Moyen complet avec bonde automatique

CODICE / COEFFICIENTE CODE / COEFFICIENT	
● CC	HJ204CC 12,4
● SS	HJ204SS 15,5
● NP	HJ204NP 14,9

PACKAGING
 L: 455 mm
 D: 310 mm
 H: 75 mm
 3,3 kg

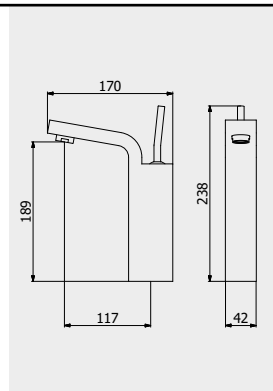

PORTATE | WATER FLOW | DÉBIT D'EAU

1 BAR	2 BAR	3 BAR
14,4 l/m	20,6 l/m	25,4 l/m

HeyJoe

ARTICLE | ARTICOLO | ARTICLE

HJ202



Tall monohole washbasin mixer complete with drain
 Miscelatore lavabo monoforo alto completo di scarico automatico
 Mitigeur lavabo Haut complet avec bonde automatique

CODICE / COEFFICIENTE CODE / COEFFICIENT	
● CC	HJ202CC 15,5
● SS	HJ202SS 19,4
● NP	HJ202NP 18,6

PACKAGING
 L: 455 mm
 D: 310 mm
 H: 75 mm
 4,3 kg

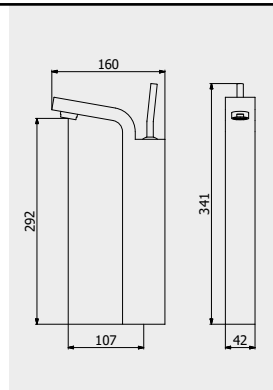

PORTATE | WATER FLOW | DÉBIT D'EAU

1 BAR	2 BAR	3 BAR
14,4 l/m	20,6 l/m	25,4 l/m

ARTICLE | ARTICOLO | ARTICLE

HJ206



Wall mounted washbasin mixer complete with drain

Miscelatore lavabo due fori a parete completo di scarico automatico

Mitigeur lavabo mural complet avec bonde automatique

CODICE / COEFFICIENTE | CODE /
COEFFICIENT | CODE / COEFFICIENT

● CC	EHJ206CC	8,8
● SS	EHJ206SS	11,0
● NP	EHJ206NP	10,6

PACKAGING

L: 265 mm
D: 260 mm
H: 70 mm

1,8 kg

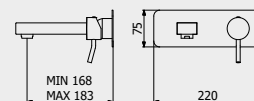

PORTATE | WATER FLOW | DÉBIT D'EAU

1 BAR	2 BAR	3 BAR
8,8 l/m	12,3 l/m	15,2 l/m

Built-in body to be purchased separately

Corpo incasso da acquistare separatamente

Corps intégré à acheter séparément



CODICE | CODE | CODE

INC206XXXN_19

COEFFICIENTE | COEFFICIENT | COEFFICIENT

2,9



ARTICLE | ARTICOLO | ARTICLE

HJ207



Wall mounted washbasin mixer with long spout complete with drain

Miscelatore lavabo due fori a parete con bocca lunga completo di scarico

Mitigeur lavabo mural bec long complet avec bonde automatique

CODICE / COEFFICIENTE | CODE /
COEFFICIENT | CODE / COEFFICIENT

● CC	EHJ207CC	9,6
● SS	EHJ207SS	12,0
● NP	EHJ207NP	11,5

PACKAGING

L: 265 mm
D: 260 mm
H: 70 mm

1,8 kg

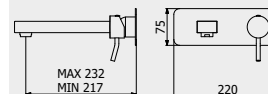

PORTATE | WATER FLOW | DÉBIT D'EAU

1 BAR	2 BAR	3 BAR
8,8 l/m	12,3 l/m	15,2 l/m

Built-in body to be purchased separately

Corpo incasso da acquistare separatamente

Corps intégré à acheter séparément



CODICE | CODE | CODE

INC206XXXN_19

COEFFICIENTE | COEFFICIENT | COEFFICIENT

2,9



ARTICLE | ARTICOLO | ARTICLE

HJ208



Wall mounted washbasin mixer with short spout complete with drain

Miscelatore lavabo due fori a parete con bocca corta completo di scarico

Mitigeur lavabo mural bec court complet avec bonde automatique

CODICE / COEFFICIENTE | CODE /
COEFFICIENT | CODE / COEFFICIENT

● CC	EHJ208CC	9,6
● SS	EHJ208SS	12,0
● NP	EHJ208NP	11,5

PACKAGING

L: 265 mm
D: 260 mm
H: 70 mm

1,8 kg

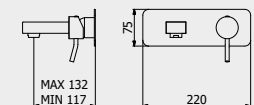

PORTATE | WATER FLOW | DÉBIT D'EAU

1 BAR	2 BAR	3 BAR
8,8 l/m	12,3 l/m	15,2 l/m

Built-in body to be purchased separately

Corpo incasso da acquistare separatamente

Corps intégré à acheter séparément



CODICE | CODE | CODE

INC206XXXN_19

COEFFICIENTE | COEFFICIENT | COEFFICIENT

2,9



ARTICLE | ARTICOLO | ARTICLE

HJ210



Ceiling spout with wall mounted mixer

Bocca da soffitto con comando remoto ad incasso

Mitigeur lavabo mural avec bec plafond complet avec bonde automatique

CODICE / COEFFICIENTE CODE / COEFFICIENT	
CC	EHJ210CC 33,8
SS	EHJ210SS 42,3

PACKAGING

- L: 150 mm
D: 190 mm
H: 98 mm
- L: 1700 mm
Ø: 70 mm
- 4,5 kg

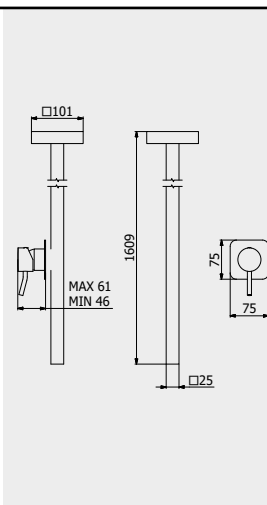

PORTATE | WATER FLOW | DÉBIT D'EAU

1 BAR	2 BAR	3 BAR
4,3 l/m	5,2 l/m	7 l/m

Built-in body to be purchased separately

Corpo incasso da acquistare separatamente

Corps intégré à acheter séparément



CODICE | CODE | CODE

INC300XXXN_19

COEFFICIENTE | COEFFICIENT | COEFFICIENT

1,8



ARTICLE | ARTICOLO | ARTICLE

HJ299



Monohole free-standing washbasin mixer complete with drain

Miscelatore lavabo da terra completo di scarico automatico

Mitigeur lavabo free standing complet avec bonde automatique

CODICE / COEFFICIENTE CODE / COEFFICIENT	
CC	HJ299CC 30,1
SS	HJ299SS 37,6
NP	HJ299NP 36,1

PACKAGING

- L: 1160 mm
D: 360 mm
H: 180 mm
- 13,8 kg

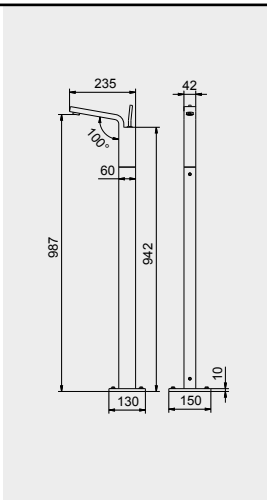

PORTATE | WATER FLOW | DÉBIT D'EAU

1 BAR	2 BAR	3 BAR
14,4 l/m	20,6 l/m	25,4 l/m

HeyJoe

ARTICLE | ARTICOLO | ARTICLE

HJ220



Monohole bidet mixer complete with drain

Miscelatore bidet monoforo completo di scarico automatico

Mitigeur bidet complet avec bonde automatique

CODICE / COEFFICIENTE | CODE /
COEFFICIENT | CODE / COEFFICIENT

● CC	HJ220CC	7,5
● SS	HJ220SS	9,4
● NP	HJ220NP	9,0

PACKAGING

L: 240 mm
D: 215 mm
H: 110 mm

2,9 kg

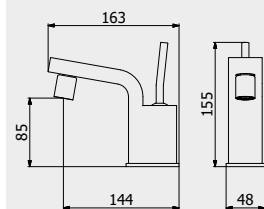

PORTATE | WATER FLOW | DÉBIT D'EAU

1 BAR	2 BAR	3 BAR
10 l/m	14,5 l/m	18 l/m

ARTICLE | ARTICOLO | ARTICLE

HJ300



Exposed parts for manual wall mixer

Set di parti esterne per miscelatore a parete ad una via

Partie extérieure pour mitigeur encastré à une voie

CODICE / COEFFICIENTE | CODE /
COEFFICIENT | CODE / COEFFICIENT

● CC	EHJ300CC	4,1
● SS	EHJ300SS	5,1
● NP	EHJ300NP	4,9

PACKAGING

L: 150 mm
D: 190 mm
H: 98 mm

1,8 kg

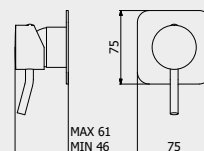

PORTATE | WATER FLOW | DÉBIT D'EAU

1 BAR	2 BAR	3 BAR
11,5 l/m	16,3 l/m	20 l/m

Built-in body to be purchased separately

Corpo incasso da acquistare separatamente

Corps intégré à acheter séparément



CODICE | CODE | CODE

INC300XXXN_19

COEFFICIENTE | COEFFICIENT | COEFFICIENT

1,8

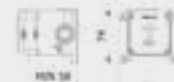

ARTICLE | ARTICOLO | ARTICLE

HJ310



Exposed parts for manual wall mixer with two ways diverter

Miscelatore doccia a parete con deviatore due vie

Mitigeur douche mural deux voies avec inverseur

CODICE / COEFFICIENTE | CODE /
COEFFICIENT | CODE / COEFFICIENT

● CC	EHJ310CC	6,1
● SS	EHJ310SS	7,6
● NP	EHJ310NP	7,3

PACKAGING

L: 150 mm
D: 190 mm
H: 98 mm

1,8 kg

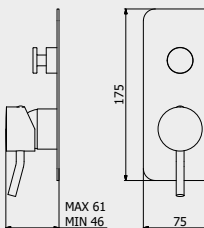

PORTATE | WATER FLOW | DÉBIT D'EAU

1 BAR	2 BAR	3 BAR
9,2 l/m	12,8 l/m	16 l/m

Built-in body to be purchased separately

Corpo incasso da acquistare separatamente

Corps intégré à acheter séparément



CODICE | CODE | CODE

INC310XXXN_19

COEFFICIENTE | COEFFICIENT | COEFFICIENT

3,3

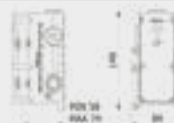

ARTICLE | ARTICOLO | ARTICLE

HJ312



Exposed parts for manual wall mixer with three ways diverter
Set di parti esterne per miscelatore a parete a tre vie
Mitigeur douche mural trois voies avec inverseur

CODICE / COEFFICIENTE CODE / COEFFICIENT		
CC	EHJ312CC	7,4
SS	EHJ312SS	9,3
NP	EHJ312NP	8,9

PACKAGING

L: 150 mm
D: 190 mm
H: 98 mm
1,8 kg

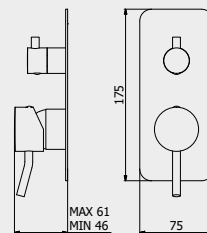

PORTATE | WATER FLOW | DÉBIT D'EAU

1 BAR	2 BAR	3 BAR
8,3 l/m	11,7 l/m	14,3 l/m

Built-in body to be purchased separately

Corpo incasso da acquistare separatamente

Corps intégré à acheter séparément



CODICE | CODE | CODE

INC312XXXN_19

COEFFICIENTE | COEFFICIENT | COEFFICIENT

3,3

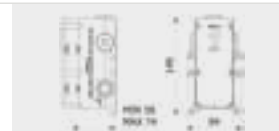

ARTICLE | ARTICOLO | ARTICLE

HJ313



Exposed parts for manual wall mixer with 2 ways with shower kit
Set di parti esterne per miscelatore a parete a due vie completo di kit doccia
Partie extérieure pour mitigeur encastré à deux voies avec douchette

CODICE / COEFFICIENTE CODE / COEFFICIENT		
CC	EHJ313CC	10,1
SS	EHJ313SS	12,6
NP	EHJ313NP	12,1

PACKAGING

L: 370 mm
D: 270 mm
H: 80 mm
2,1 kg

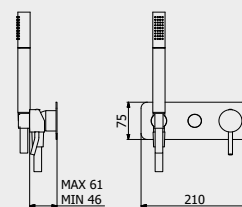

PORTATE | WATER FLOW | DÉBIT D'EAU

1 BAR	2 BAR	3 BAR
10 l/m	14,1 l/m	17,2 l/m

Built-in body to be purchased separately

Corpo incasso da acquistare separatamente

Corps intégré à acheter séparément



CODICE | CODE | CODE

INC313XXXN_19

COEFFICIENTE | COEFFICIENT | COEFFICIENT

3,6



ARTICLE | ARTICOLO | ARTICLE

HJ314



Exposed parts for manual wall mixer with 3 ways with shower kit
Set di parti esterne per miscelatore a parete a tre vie completo di kit doccia
Partie extérieure pour mitigeur encastré à trois voies avec douchette

CODICE / COEFFICIENTE CODE / COEFFICIENT		
CC	EHJ314CC	11,4
SS	EHJ314SS	14,3
NP	EHJ314NP	13,7

PACKAGING

L: 370 mm
D: 270 mm
H: 80 mm
2,1 kg

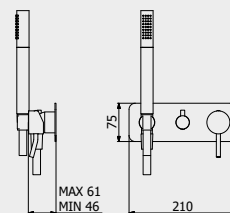

PORTATE | WATER FLOW | DÉBIT D'EAU

Built-in body to be purchased separately

Corpo incasso da acquistare separatamente

Corps intégré à acheter séparément



CODICE | CODE | CODE

INC314XXXN_19

COEFFICIENTE | COEFFICIENT | COEFFICIENT

3,7



HeyJoe

ARTICLE | ARTICOLO | ARTICLE

HJ250



Wall mounted bath filler complete with hand shower kit
Bordo vasca esterno a parete completo di kit doccia
Mitigeur Bain/douche Mural avec douchette encastrée

CODICE / COEFFICIENTE | CODE / COEFFICIENT

● CC	HJ250CC	17,1
● SS	HJ250SS	21,4
● NP	HJ250NP	20,5

PACKAGING

L: 360 mm
 D: 220 mm
 H: 220 mm

5,3 kg

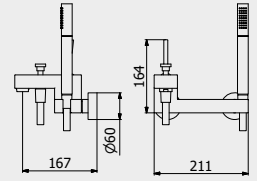

PORTATE | WATER FLOW | DÉBIT D'EAU

1 BAR	2 BAR	3 BAR
12,5 l/m	18 l/m	20 l/m

ARTICLE | ARTICOLO | ARTICLE

HJ399



Free-standing bath filler with shower kit
Bordo vasca da terra con kit doccia
Bain douche complet alimentation au sol

CODICE / COEFFICIENTE | CODE / COEFFICIENT

● CC	HJ399CC	41,9
● SS	HJ399SS	52,4
● NP	HJ399NP	50,3

PACKAGING

L: 1080 mm
 D: 384 mm
 H: 120 mm

15 kg

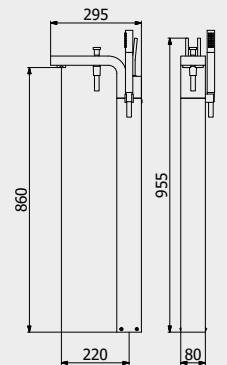

PORTATE | WATER FLOW | DÉBIT D'EAU

1 BAR	2 BAR	3 BAR
18 l/m	25 l/m	31 l/m

ARTICLE | ARTICOLO | ARTICLE

HJ740



Two holes deck mounted bath filler mixer with shower kit
Miscelatore Bordo vasca da appoggio due fori con doccino
Mitigeur bain/douche deux trous avec douchette

CODICE / COEFFICIENTE | CODE / COEFFICIENT

● CC	HJ740CC	21,4
● SS	HJ740SS	26,8
● NP	HJ740NP	25,7

PACKAGING

L: 360 mm
 D: 220 mm
 H: 150 mm

5,2 kg

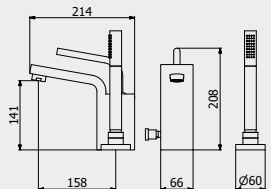

PORTATE | WATER FLOW | DÉBIT D'EAU

1 BAR	2 BAR	3 BAR
21,5 l/m	30 l/m	38 l/m



ARTICLE | ARTICOLO | ARTICLE

HJ750



Deck mounted bath filler mixer
Miscelatore bordo vasca da appoggio
Mitigeur bain/douche

CODICE / COEFFICIENTE CODE / COEFFICIENT	
CC	HJ750CC 17,5
SS	HJ750SS 21,9
NP	HJ750NP 21,0

PACKAGING

L: 360 mm
D: 220 mm
H: 150 mm
4,2 kg

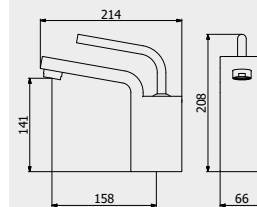

PORTATE | WATER FLOW | DÉBIT D'EAU

1 BAR	2 BAR	3 BAR
21,5 l/m	30 l/m	38 l/m

ARTICLE | ARTICOLO | ARTICLE

RU318



Built-in wall mounted waterfall spout
Cascata a parete con erogazione a lama esterna
Cascade murale avc bec externe

CODICE / COEFFICIENTE CODE / COEFFICIENT	
CC	RU318CC 22,9
SS	RU318SS 28,6
NP	RU318NP 27,5

PACKAGING

L: 340 mm
D: 180 mm
H: 70 mm
4,0 kg

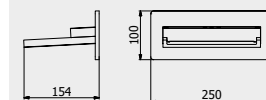

PORTATE | WATER FLOW | DÉBIT D'EAU

1 BAR	2 BAR	3 BAR
13 l/m	17,7 l/m	20 l/m

HeyJoe

ARTICLE | ARTICOLO | ARTICLE

RU319



Wall mounted waterfall
Cascata a parete con erogazione diretta
Cascade murale

CODICE / COEFFICIENTE CODE / COEFFICIENT	
CC	RU319CC 12,8
SS	RU319SS 16,0
NP	RU319NP 15,4

PACKAGING

L: 340 mm
D: 180 mm
H: 70 mm
3,1 kg

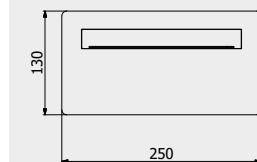

PORTATE | WATER FLOW | DÉBIT D'EAU

1 BAR	2 BAR	3 BAR
13 l/m	17,7 l/m	20 l/m

ARTICLE | ARTICOLO | ARTICLE

RU320



Wall mounted spout

Bocca d'erogazione a parete

Bec de remplissage mural

CODICE / COEFFICIENTE | CODE /
COEFFICIENT | CODE / COEFFICIENT

● CC	RU320CC	2,5
● SS	RU320SS	3,1
● NP	RU320NP	3,0

PACKAGING

L: 210 mm
D: 130 mm
H: 70 mm

1,1 kg

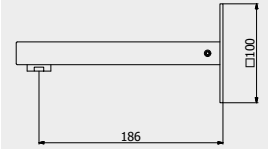

PORTATE | WATER FLOW | DÉBIT D'EAU

1 BAR	2 BAR	3 BAR
15 l/m	19 l/m	24 l/m

ARTICLE | ARTICOLO | ARTICLE

RU321



Short wall mounted spout

Bocca d'erogazione corta a parete

Bec de remplissage mural court

CODICE / COEFFICIENTE | CODE /
COEFFICIENT | CODE / COEFFICIENT

● CC	RU321CC	3,0
● SS	RU321SS	3,8
● NP	RU321NP	3,6

PACKAGING

L: 210 mm
D: 130 mm
H: 70 mm

1 kg

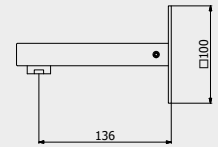

PORTATE | WATER FLOW | DÉBIT D'EAU

1 BAR	2 BAR	3 BAR
15 l/m	19 l/m	24 l/m

ARTICLE | ARTICOLO | ARTICLE

RU322



Long wall mounted spout

Bocca d'erogazione lunga a parete

Bec de remplissage mural long

CODICE / COEFFICIENTE | CODE /
COEFFICIENT | CODE / COEFFICIENT

● CC	RU322CC	3,0
● SS	RU322SS	3,8
● NP	RU322NP	3,6

PACKAGING

L: 210 mm
D: 130 mm
H: 70 mm

1,2 kg

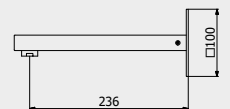

PORTATE | WATER FLOW | DÉBIT D'EAU

1 BAR	2 BAR	3 BAR
15 l/m	19 l/m	24 l/m

ARTICLE | ARTICOLO | ARTICLE

HJ800



Shower column with mixer and shower kit

Colonna doccia con miscelatore e e kit doccia

Ccolonne de douche avec mitigeur et kit douche

CODICE / COEFFICIENTE | CODE /
COEFFICIENT | CODE / COEFFICIENT

● CC	HJ800CC	52,9
------	---------	------

PACKAGING

L: 3700 mm
D: 2800 mm
H: 1070 mm

14,7 kg

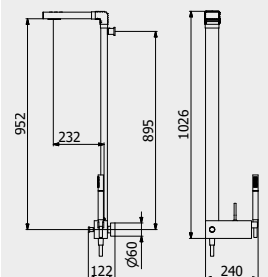

PORTATE | WATER FLOW | DÉBIT D'EAU

1 BAR	2 BAR	3 BAR
9,6 l/m	15 l/m	18,5 l/m

ARTICLE | ARTICOLO | ARTICLE

HJ706



Exposed parts for bidet spray complete with mixer
Set di parti esterne per Idroscopino igienico con miscelatore
Partie extérieure pour douchette hygiénique avec mitigeur

CODE / COEFFICIENT CODICE / COEFFICIENTE CODE / COEFFICIENT	
● CC	EHJ706CC 9,8
● SS	EHJ706SS 12,3
● NP	EHJ706NP 11,8

PACKAGING

L: 370 mm
D: 270 mm
H: 80 mm

3,1 kg

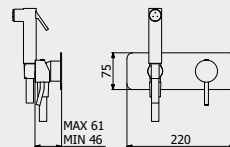

PORTATE | WATER FLOW | DÉBIT D'EAU

1 BAR	2 BAR	3 BAR
2,3 l/m	3,2 l/m	4 l/m

Built-in body to be purchased separately

Corpo incasso da acquistare separatamente

Corps intégré à acheter séparément



CODICE | CODE | CODE

INC206XXXN_19

COEFFICIENTE | COEFFICIENT | COEFFICIENT

2,9

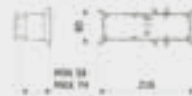

ARTICLE | ARTICOLO | ARTICLE

HJ370



Single Lever kitchen mixer
Lavello monoforo da cucina
Évier de cuisine

CODICE / COEFFICIENTE CODE / COEFFICIENTE CODE / COEFFICIENT	
● CC	HJ370CC 14,0
● SS	HJ370SS 17,5
● NP	HJ370NP 16,8

PACKAGING

L: 455 mm
D: 310 mm
H: 75 mm

3,4 kg

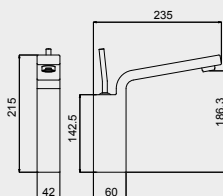

PORTATE | WATER FLOW | DÉBIT D'EAU

1 BAR	2 BAR	3 BAR
14,4 l/m	20,6 l/m	25,4 l/m

HeyJoe

SNATCH / ACCESSORIES COLLECTION

ARTICLE | ARTICOLO | ARTICLE

HJ001

Wall soap-holder
Porta sapone a muro
Porte distributeur de savon encastré



CODICE / COEFFICIENTE | CODE / COEFFICIENT

CC	HJ001CC	5,5
SS	HJ001SS	5,7
BO	HJ001BO	5,7
NP	HJ001NP	5,7
CF	HJ001CF	5,7
CS	HJ001CS	5,7
II	HJ001II	5,7
IS	HJ001IS	5,7
RS	HJ001RS	5,7
SR	HJ001SR	5,7
OO	HJ001OO	5,7
OS	HJ001OS	5,7

PACKAGING

L: 150 mm
D: 190 mm
H: 98 mm 0,4 kg

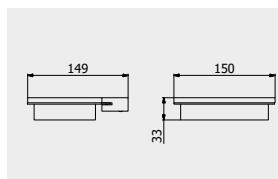

ARTICLE | ARTICOLO | ARTICLE

HJ003

Wall toothbrush holder
Porta spazzolino a muro
Porte brosse à dents encastré



CODICE / COEFFICIENTE | CODE / COEFFICIENT

CC	HJ003CC	6,1
SS	HJ003SS	6,3
BO	HJ003BO	6,3
NP	HJ003NP	6,3
CF	HJ003CF	6,3
CS	HJ003CS	6,3
II	HJ003II	6,3
IS	HJ003IS	6,3
RS	HJ003RS	6,3
SR	HJ003SR	6,3
OO	HJ003OO	6,3
OS	HJ003OS	6,3

PACKAGING

L: 175 mm
D: 125 mm
H: 90 mm 0,2 kg

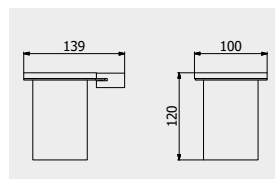

ARTICLE | ARTICOLO | ARTICLE

HJ016

Soap dispenser
Porta sapone da appoggio
Porte distributeur de savon



CODICE / COEFFICIENTE | CODE / COEFFICIENT

CC	HJ016CC	2,2
SS	HJ016SS	2,4
BO	HJ016BO	2,4
NP	HJ016NP	2,4
CF	HJ016CF	2,4
CS	HJ016CS	2,4
II	HJ016II	2,4
IS	HJ016IS	2,4
RS	HJ016RS	2,4
SR	HJ016SR	2,4
OO	HJ016OO	2,4
OS	HJ016OS	2,4

PACKAGING

L: 150 mm
D: 190 mm
H: 98 mm 1,1 kg

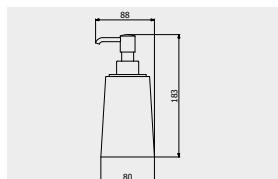

ARTICLE | ARTICOLO | ARTICLE

HJ017

Soap holder
Porta sapone da appoggio
Porte savon



CODICE / COEFFICIENTE | CODE / COEFFICIENT

CC	HJ017CC	3,8
----	---------	-----

PACKAGING

L: 175 mm
D: 125 mm
H: 90 mm 0,5 kg

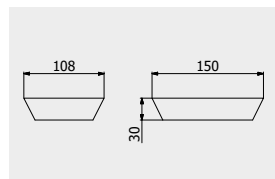

ARTICLE | ARTICOLO | ARTICLE

HJ010

Shelf
Mensola
Etagèr

CODICE / COEFFICIENTE | CODE / COEFFICIENT | CODE / COEFFICIENT

CC	HJ010CC	5,1
SS	HJ010SS	5,3
BO	HJ010BO	5,3
NP	HJ010NP	5,3
CF	HJ010CF	5,3
CS	HJ010CS	5,3
II	HJ010II	5,3
IS	HJ010IS	5,3
RS	HJ010RS	5,3
SR	HJ010SR	5,3
OO	HJ010OO	5,3
OS	HJ010OS	5,3

PACKAGING

📦	L: 175 mm	📦	0,4 kg
	D: 125 mm		
	H: 90 mm		

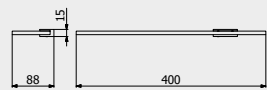

ARTICLE | ARTICOLO | ARTICLE

HJ011

Toilet paper holder
Porta rotolo
Porte rouleaux de toilette

CODICE / COEFFICIENTE | CODE / COEFFICIENT | CODE / COEFFICIENT

CC	HJ011CC	3,5
SS	HJ011SS	4,4
BO	HJ011BO	4,4
NP	HJ011NP	4,2
CF	HJ011CF	5,3
CS	HJ011CS	5,7
II	HJ011II	5,3
IS	HJ011IS	5,7
RS	HJ011RS	5,3
SR	HJ011SR	5,7
OO	HJ011OO	5,7
OS	HJ011OS	5,3

PACKAGING

📦	L: 150 mm	📦	0,7 kg
	D: 100 mm		
	H: 70 mm		

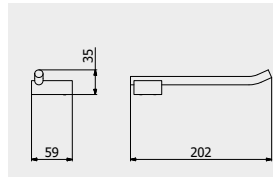

ARTICLE | ARTICOLO | ARTICLE

HJ009

Double robe hook
Doppio appendino a paret
Double cintre

CODICE / COEFFICIENTE | CODE / COEFFICIENT | CODE / COEFFICIENT

CC	HJ009CC	3,4
SS	HJ009SS	4,3
BO	HJ009BO	4,3
NP	HJ009NP	4,3
CF	HJ009CF	5,1
CS	HJ009CS	5,4
II	HJ009II	5,4
IS	HJ009IS	5,4
RS	HJ009RS	5,1
SR	HJ009SR	5,4
OO	HJ009OO	5,1
OS	HJ009OS	5,4

PACKAGING

📦	L: 150 mm	📦	0,4 kg
	D: 100 mm		
	H: 70 mm		

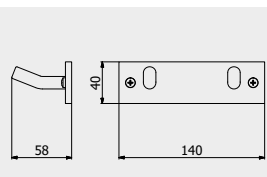

ARTICLE | ARTICOLO | ARTICLE

HJ004

Towel holder
Porta salvietta
Porte-serviette

CODICE / COEFFICIENTE | CODE / COEFFICIENT | CODE / COEFFICIENT

CC	HJ004CC	7,5
SS	HJ004SS	9,4
BO	HJ004BO	9,4
NP	HJ004NP	9,4
CF	HJ004CF	11,3
CS	HJ004CS	12,0
II	HJ004II	11,3
IS	HJ004IS	12,0
RS	HJ004RS	11,3
SR	HJ004SR	12,0
OO	HJ004OO	11,3
OS	HJ004OS	12,0

PACKAGING

📦	L: 782 mm	📦	1,9 kg
	D: 135 mm		
	H: 80 mm		

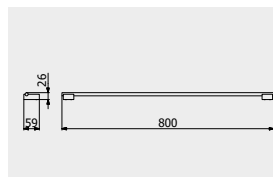

ARTICLE | ARTICOLO | ARTICLE

HJ014

Towel holder
Porta salvietta
Porte-serviette

CODICE / COEFFICIENTE | CODE / COEFFICIENT | CODE / COEFFICIENT

CC	HJ014CC	5,1
SS	HJ014SS	6,4
BO	HJ014BO	6,4
NP	HJ014NP	6,4
CF	HJ014CF	7,7
CS	HJ014CS	8,2
II	HJ014II	7,7
IS	HJ014IS	8,2
RS	HJ014RS	7,7
SR	HJ014SR	8,2
OO	HJ014OO	7,7
OS	HJ014OS	8,2

PACKAGING

📦	L: 100 mm	📦	1,1 kg
	D: 100 mm		
	H: 50 mm		

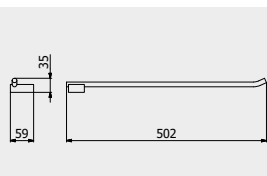

ARTICLE | ARTICOLO | ARTICLE

HJ006

Towel holder
Porta salvietta
Porte-serviette

CODICE / COEFFICIENTE | CODE / COEFFICIENT | CODE / COEFFICIENT

CC	HJ006CC	4,9
SS	HJ006SS	6,1
BO	HJ006BO	6,1
NP	HJ006NP	6,1
CF	HJ006CF	7,4
CS	HJ006CS	7,8
II	HJ006II	7,4
IS	HJ006IS	7,8
RS	HJ006RS	7,4
SR	HJ006SR	7,8
OO	HJ006OO	7,4
OS	HJ006OS	7,8

PACKAGING

📦	L: 175 mm	📦	0,9 kg
	D: 125 mm		
	H: 90 mm		

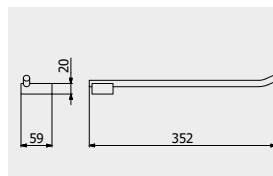

HeyJoe

ARTICLE | ARTICOLO | ARTICLE

HJ007

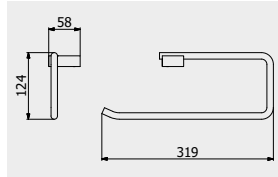

Ring Towel holder

Porta salvietta ad anello

Porte-serviette anneau

CODICE / COEFFICIENTE | CODE /
COEFFICIENT | CODE / COEFFICIENT

CC	HJ007CC	5,0
SS	HJ007SS	6,3
BO	HJ007BO	6,3
NP	HJ007NP	6,3
CF	HJ007CF	7,5
CS	HJ007CS	8,0
II	HJ007II	7,5
IS	HJ007IS	8,0
RS	HJ007RS	7,5
SR	HJ007SR	8,0
OO	HJ007OO	7,5
OS	HJ007OS	8,0

PACKAGING

📦	L: 340 mm	📦	1,9 kg
	D: 180 mm		
	H: 70 mm		

ARTICLE | ARTICOLO | ARTICLE

HJ012

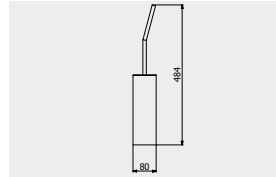

Toilet brush holder

Porta scopino da terra

Porte balayette au sol

CODICE / COEFFICIENTE | CODE /
COEFFICIENT | CODE / COEFFICIENT

CC	HJ012CC	7,8
SS	HJ012SS	9,8
BO	HJ012BO	9,8
NP	HJ012NP	9,8
CF	HJ012CF	11,7
CS	HJ012CS	12,5
II	HJ012II	11,7
IS	HJ012IS	12,5
RS	HJ012RS	11,7
SR	HJ012SR	12,5
OO	HJ012OO	11,7
OS	HJ012OS	12,5

PACKAGING

📦	L: 100 mm	📦	1,8 kg
	D: 100 mm		
	H: 50 mm		

ARTICLE | ARTICOLO | ARTICLE

HJ015

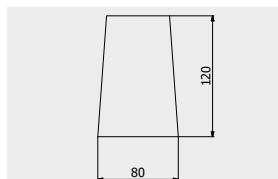

Toothbrush holder

Porta spazzolino

Porte brosse à dents

CODICE / COEFFICIENTE | CODE /
COEFFICIENT | CODE / COEFFICIENT

CC	HJ015CC	2,8
----	---------	-----

PACKAGING

📦	L: 175 mm	📦	0,6 kg
	D: 125 mm		
	H: 90 mm		

ARTICLE | ARTICOLO | ARTICLE

HJ018

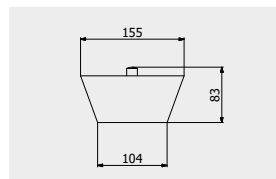

Box

Scatola

Boîte

CODICE / COEFFICIENTE | CODE /
COEFFICIENT | CODE / COEFFICIENT

CC	HJ018CC	4,1
SS	HJ018SS	4,3
BO	HJ018BO	4,3
NP	HJ018NP	4,3
CF	HJ018CF	4,3
CS	HJ018CS	4,3
II	HJ018II	4,3
IS	HJ018IS	4,3
RS	HJ018RS	4,3
SR	HJ018SR	4,3
OO	HJ018OO	4,3
OS	HJ018OS	4,3

PACKAGING

📦	L: 240 mm	📦	1,2 kg
	D: 215 mm		
	H: 110 mm		





WOW

A classic can be amazing always and everywhere.

Un classico è capace di stupire sempre e ovunque.
Un classique demeure incroyable toujours et partout.

If you like something, you don't change it, at most you can only improve it. WOW is a modern reinterpretation of a bathroom design icon. The modernity of the slim clean forms is integrated respecting the classic and elegant taste that distinguishes this emblematic product, since a classic cannot be touched, but only respected in its aptitude to amaze always and everywhere.

Se qualcosa ti piace non lo cambi, al massimo lo migliori. WOW è un'interpretazione in chiave odierna di un'icona del design per il bagno. La modernità delle forme slanciate e pulite si innesta nel rispetto del gusto classico ed elegante che contraddistingue questo prodotto emblematico. Perché un classico non si tocca, lo si rispetta nella sua capacità di stupire sempre e ovunque.

Si on aime quelque chose on ne va pas le changer, au plus on cherche à l'améliorer. WOW est une interprétation actuelle d'une icône du design pour la salle de bain. La modernité des formes élancées et nettes se greffe sur le goût classique et élégant qui caractérise ce produit emblématique. Parce qu'un classique ne peut pas être touché, il doit être respecté dans sa capacité d'émerveiller toujours et partout.



ANTI-LIMESCALE
AREATOR



LEAD FREE



ZINC FREE





Wow





Wow

- ↶ W0306CC
Wall mounted widespread lavatory faucet
Rubinetto lavabo da incasso
Robinet de lavabo mural

- ↗ W0398CC
Five holes deck mounted bath filler with
shower kit
Bordo vasca a parete cinque fori con
deviatore e kit doccia
Bain cinq trous avec inverseur et Kit Douche



↑ **WO398CC**
Five holes wall mounted bath filler with shower kit
 Bordo vasca a parete cinque fori con deviatore e kit doccia
 Bain/douche 5 trous avec inverseur et Kit Douche

→ **WO410CC**
Three holes wall mounted shower with two ways diverter
 Tre rubinetti a parete per doccia con deviatore a due vie
 Melangeur trois trous douche avec inverseur deux voies

SH022CC
 Duplex



Wow

ARTICLE | ARTICOLO | ARTICLE

WO205



Monohole washbasin with two handles complete with drain
Lavabo monoforo con due leve completo di scarico automatico
Mélangeur lavabo monotrou complet avec bonde automatique

CODICE / COEFFICIENTE | CODE / COEFFICIENT

●	CC	WO205CC	8,8
●	SS	WO205SS	10,9
●	BO	WO205BO	10,5
●	NP	WO205NP	10,5
●	CF	WO205CF	13,1
●	CS	WO205CS	14,0
●	SR	WO205SR	14,0
●	OO	WO205OO	13,1
●	ON	WO205ON	8,8

PACKAGING

L: 460 mm
D: 250 mm
H: 75 mm

2,2 kg

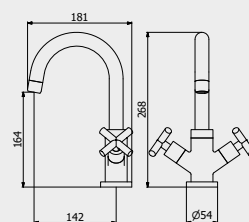

PORTATE | WATER FLOW | DÉBIT D'EAU

1 BAR	2 BAR	3 BAR
10 l/m	14 l/m	18 l/m

ARTICLE | ARTICOLO | ARTICLE

WO306



Wall mounted washbasin mixer complete with drain

Miscelatore lavabo tre fori a parete completo di scarico automatico
Mitigeur lavabo encastré complet avec bonde automatique

CODICE / COEFFICIENTE | CODE / COEFFICIENT

●	CC	WO306CC	6,5
●	SS	WO306SS	8,1
●	BO	WO306BO	7,8
●	NP	WO306NP	7,8
●	OO	WO306OO	9,8

PACKAGING

L: 290 mm
D: 270 mm
H: 70 mm

2,1 kg

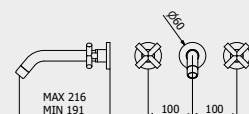

PORTATE | WATER FLOW | DÉBIT D'EAU

1 BAR	2 BAR	3 BAR
11 l/m	15 l/m	18,5 l/m

ARTICLE | ARTICOLO | ARTICLE

WO390



Three holes washbasin set with tall spout

Lavabo tre fori bocca alta completo di scarico automatico
Lavabo trois trous bec haut

CODICE / COEFFICIENTE | CODE / COEFFICIENT

●	CC	WO390CC	7,5
●	SS	WO390SS	9,4
●	BO	WO390BO	9,0
●	NP	WO390NP	9,0
●	OO	WO390OO	11,3

PACKAGING

L: 245 mm
D: 340 mm
H: 80 mm

2,2 kg

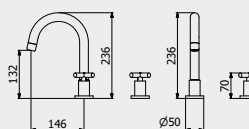

PORTATE | WATER FLOW | DÉBIT D'EAU

1 BAR	2 BAR	3 BAR
14 l/m	17 l/m	22 l/m

ARTICLE | ARTICOLO | ARTICLE

WO225



Monohole bidet with two handles complete with drain

Bidet monoforo con due leve completo di scarico automatico
Mélangeur bidet monotrou complet avec bonde automatique

CODICE / COEFFICIENTE | CODE / COEFFICIENT

●	CC	WO225CC	6,0
●	SS	WO225SS	7,5
●	BO	WO225BO	7,2
●	NP	WO225NP	7,2
●	OO	WO225OO	9,0

PACKAGING

L: 220 mm
D: 290 mm
H: 80 mm

2,0 kg

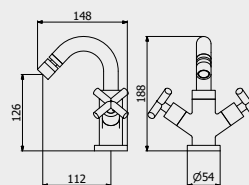

PORTATE | WATER FLOW | DÉBIT D'EAU

1 BAR	2 BAR	3 BAR
13 l/m	18 l/m	22 l/m



ARTICLE | ARTICOLO | ARTICLE

WO250



Wall mounted bath filler complete with hand shower kit
Bordo vasca esterno a parete completo di kit doccia
Mitigeur bain/douche mural avec douchette encastrée

CODICE / COEFFICIENTE CODE / COEFFICIENT		
COEFFICIENT	CODE	COEFFICIENT
● CC	WO250CC	9,3
● SS	WO250SS	11,6
● BO	WO250BO	11,2
● NP	WO250NP	11,2
● OO	WO250OO	14,0

PACKAGING

📦	L: 225 mm
	D: 170 mm
	H: 185 mm
⚖️	2,6 kg

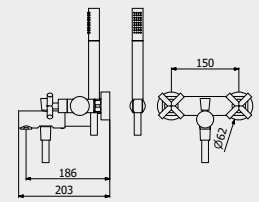

PORTATE | WATER FLOW | DÉBIT D'EAU

1 BAR	2 BAR	3 BAR
12 l/m	17,1 l/m	21 l/m

ARTICLE | ARTICOLO | ARTICLE

WO350



Wall mounted bath filler complete with hand shower kit
Bordo vasca esterno a parete completo di kit doccia
Mitigeur bain/douche mural avec douchette encastrée

CODICE / COEFFICIENTE CODE / COEFFICIENT		
COEFFICIENT	CODE	COEFFICIENT
● CC	WO350CC	6,7
● SS	WO350SS	8,4
● BO	WO350BO	8,0
● NP	WO350NP	8,0
● OO	WO350OO	10,1

PACKAGING

📦	L: 230 mm
	D: 175 mm
	H: 160 mm
⚖️	2,0 kg

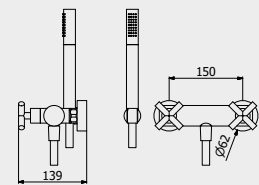

PORTATE | WATER FLOW | DÉBIT D'EAU

1 BAR	2 BAR	3 BAR
13 l/m	16 l/m	26 l/m

ARTICLE | ARTICOLO | ARTICLE

WO400



Two holes wall mounted shower
Coppia di rubinetti a parete per doccia una via
Melangeur deux trous douche une voie

CODICE / COEFFICIENTE CODE / COEFFICIENT		
COEFFICIENT	CODE	COEFFICIENT
● CC	WO400CC	8,1
● SS	WO400SS	10,1
● BO	WO400BO	9,7
● NP	WO400NP	9,7
● OO	WO400OO	12,2

PACKAGING

📦	L: 340 mm
	D: 180 mm
	H: 70 mm
⚖️	2,3 kg

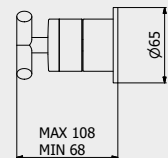

PORTATE | WATER FLOW | DÉBIT D'EAU

1 BAR	2 BAR	3 BAR
28 l/m	40 l/m	49,3 l/m

ARTICLE | ARTICOLO | ARTICLE

WO410



Three holes wall mounted shower with two ways diverter
Tre rubinetti a parete per doccia con deviatore a due vie
Melangeur trois trous douche avec inverseur deux voies

CODICE / COEFFICIENTE CODE / COEFFICIENT		
COEFFICIENT	CODE	COEFFICIENT
● CC	WO410CC	13,6
● SS	WO410SS	17,0
● BO	WO410BO	16,3
● NP	WO410NP	16,3
● OO	WO410OO	20,4

PACKAGING

📦	L: 340 mm
	D: 180 mm
	H: 70 mm
⚖️	2,3 kg

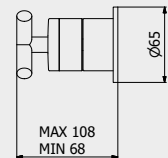

PORTATE | WATER FLOW | DÉBIT D'EAU

1 BAR	2 BAR	3 BAR
16 l/m	22,4 l/m	27,4 l/m

ARTICLE | ARTICOLO | ARTICLE

W0700



Free-standing bath filler with shower kit

Bordo vasca da terra con kit doccia

Bain douche complet alimentation au sol

CODICE / COEFFICIENTE | CODE /
COEFFICIENT | CODE / COEFFICIENT

●	CC	W0700CC	39,6
●	SS	W0700SS	49,5
●	BO	W0700BO	47,5
●	NP	W0700NP	47,5
●	OO	W0700OO	59,4

PACKAGING

 L: 360 mm
D: 220 mm
H: 150 mm

 L: 200 mm
D: 200 mm
H: 150 mm

7,9 kg

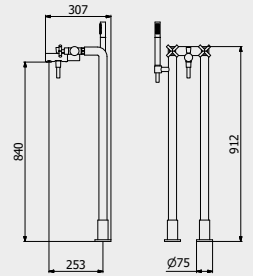

PORTATE | WATER FLOW | DÉBIT D'EAU

1 BAR	2 BAR	3 BAR
20 l/m	26 l/m	32 l/m

ARTICLE | ARTICOLO | ARTICLE

W0320



Wall mounted spout

Bocca d'erogazione a parete

Bec de remplissage mural

CODICE / COEFFICIENTE | CODE /
COEFFICIENT | CODE / COEFFICIENT

●	CC	W0320CC	2,1
●	SS	W0320SS	2,6
●	BO	W0320BO	2,5
●	NP	W0320NP	2,5
●	OO	W0320OO	3,2

PACKAGING

 L: 175 mm
D: 125 mm
H: 90 mm

0,2 kg

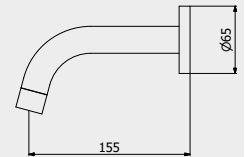

PORTATE | WATER FLOW | DÉBIT D'EAU

1 BAR	2 BAR	3 BAR
10 l/m	14 l/m	17 l/m

ARTICLE | ARTICOLO | ARTICLE

W0321



Short wall mounted spout

Bocca d'erogazione corta a parete

Bec de remplissage mural court

CODICE / COEFFICIENTE | CODE /
COEFFICIENT | CODE / COEFFICIENT

●	CC	W0321CC	2,5
●	SS	W0321SS	3,1
●	BO	W0321BO	3,0
●	NP	W0321NP	3,0
●	OO	W0321OO	3,8

PACKAGING

 L: 175 mm
D: 125 mm
H: 90 mm

0,2 kg

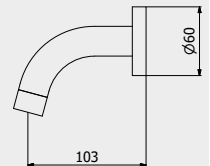

PORTATE | WATER FLOW | DÉBIT D'EAU

1 BAR	2 BAR	3 BAR
10 l/m	14 l/m	17 l/m

ARTICLE | ARTICOLO | ARTICLE

MT322



Long wall mounted spout

Bocca d'erogazione lunga a parete

Bec de remplissage mural long

CODICE / COEFFICIENTE | CODE /
COEFFICIENT | CODE / COEFFICIENT

●	CC	MT322CC	2,5
●	SS	MT322SS	3,1
●	BO	MT322BO	3,0
●	NP	MT322NP	3,0
●	OO	MT322OO	3,8

PACKAGING

 L: 175 mm
D: 125 mm
H: 90 mm

0,2 kg

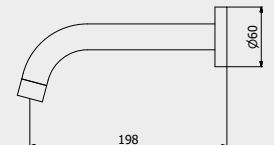

PORTATE | WATER FLOW | DÉBIT D'EAU

1 BAR	2 BAR	3 BAR
10 l/m	14 l/m	17 l/m



MODERNA / ACCESSORIES COLLECTION

ARTICLE | ARTICOLO | ARTICLE

MO001

Wall soap-holder

Porta sapone a muro
Porte distributeur de savon encastré

CODE / COEFFICIENT | CODICE /
COEFFICIENTE | CODE / COEFFICIENT

CC MO001CC 1,5

PACKAGING

L: 110 mm
D: 130 mm
H: 50 mm

0,4 kg

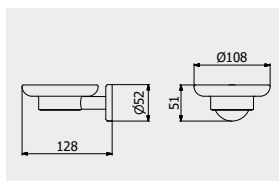

ARTICLE | ARTICOLO | ARTICLE

MO002

Wall soap dispenser holder

Porta dispenser sapone liquido a parete
Porte distributeur de savon en verre gravé

CODE / COEFFICIENT | CODICE /
COEFFICIENTE | CODE / COEFFICIENT

CC MO002CC 2,3

PACKAGING

L: 80 mm
D: 130 mm
H: 180 mm

0,1 kg

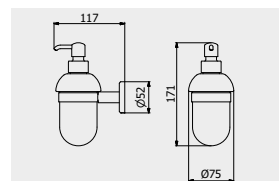

ARTICLE | ARTICOLO | ARTICLE

MO003

Wall toothbrush holder

Bicchiera porta spazzolino a parete
Porte-verre en verre gravé

CODE / COEFFICIENT | CODICE /
COEFFICIENTE | CODE / COEFFICIENT

CC MO003CC 1,5

PACKAGING

L: 70 mm
D: 110 mm
H: 100 mm

0,4 kg

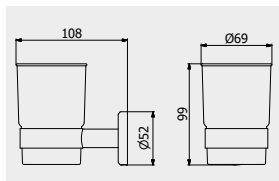

ARTICLE | ARTICOLO | ARTICLE

MO004

Towel holder

Porta salvietta
Porte-serviette

CODE / COEFFICIENT | CODICE /
COEFFICIENTE | CODE / COEFFICIENT

CC MO004CC 2,4

PACKAGING

L: 650 mm
D: 70 mm
H: 50 mm

0,5 kg

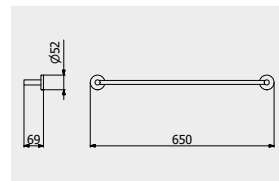

ARTICLE | ARTICOLO | ARTICLE

MO014

Towel holder

Porta salvietta
Porte-serviette

CODE / COEFFICIENT | CODICE /
COEFFICIENTE | CODE / COEFFICIENT

CC MO014CC 2,2

PACKAGING

L: 500 mm
D: 70 mm
H: 50 mm

0,5 kg

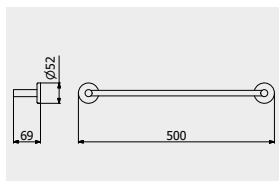

ARTICLE | ARTICOLO | ARTICLE

MO006

Towel holder

Porta salvietta
Porte-serviette

CODE / COEFFICIENT | CODICE /
COEFFICIENTE | CODE / COEFFICIENT

CC MO006CC 2,1

PACKAGING

L: 350 mm
D: 70 mm
H: 50 mm

0,4 kg

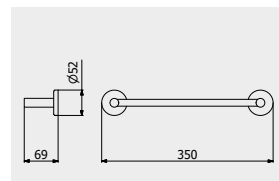

Wow

ARTICLE | ARTICOLO | ARTICLE

M0007



Ring Towel holder

Porta salvietta ad anello

Porte-serviette anneau

CODE / COEFFICIENT | CODICE /
COEFFICIENTE | CODE / COEFFICIENT

CC M0007CC 1,6

PACKAGING

L: 180 mm
D: 70 mm
H: 200 mm

0,8 kg

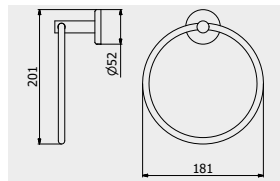

ARTICLE | ARTICOLO | ARTICLE

M0008



Robe Hook

Appendino a parete

Cintre

CODE / COEFFICIENT | CODICE /
COEFFICIENTE | CODE / COEFFICIENT

CC M0008CC 0,9

PACKAGING

L: 50 mm
D: 50 mm
H: 50 mm

0,3 kg

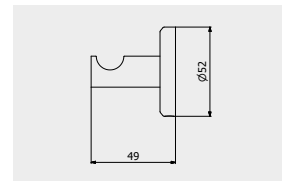

ARTICLE | ARTICOLO | ARTICLE

M0009



Double robe hook

Doppio appendino a parete

Double cintre

CODE / COEFFICIENT | CODICE /
COEFFICIENTE | CODE / COEFFICIENT

CC M0009CC 1,4

PACKAGING

L: 70 mm
D: 70 mm
H: 50 mm

0,1 kg

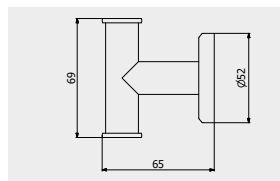

ARTICLE | ARTICOLO | ARTICLE

M0010



Shelf

Mensola

Etagère

CODE / COEFFICIENT | CODICE /
COEFFICIENTE | CODE / COEFFICIENT

CC M0010CC 3,0

PACKAGING

L: 600 mm
D: 140 mm
H: 50 mm

0,3 kg

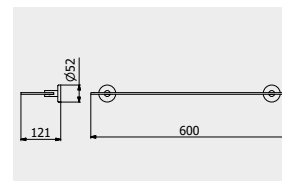

ARTICLE | ARTICOLO | ARTICLE

M0005



Swiveable towel holder

Porta salvietta doppio

Porte-serviette noeud

CODE / COEFFICIENT | CODICE /
COEFFICIENTE | CODE / COEFFICIENT

CC M0005CC 3,5

PACKAGING

L: 430 mm
D: 70 mm
H: 50 mm

0,5 kg

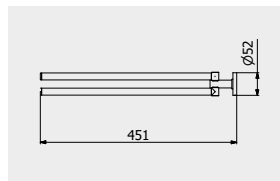

ARTICLE | ARTICOLO | ARTICLE

M0011



Toilet paper holder

Porta rotolo

Porte rouleaux de toilette

CODE / COEFFICIENT | CODICE /
COEFFICIENTE | CODE / COEFFICIENT

CC M0011CC 1,4

PACKAGING

L: 150 mm
D: 70 mm
H: 50 mm

0,2 kg

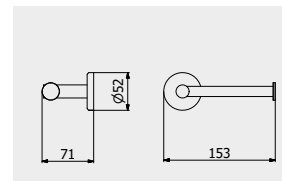

ARTICLE | ARTICOLO | ARTICLE

M0012



Toilet brush holder

Porta scopino da terra

Porte balayette au sol

CODE / COEFFICIENT | CODICE /
COEFFICIENTE | CODE / COEFFICIENT

CC M0012CC 2,5

PACKAGING

L: 80 mm
D: 80 mm
H: 380 mm

0,7 kg

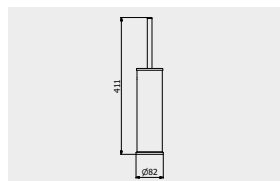

ARTICLE | ARTICOLO | ARTICLE

M0013



Wall toilet brush holder

Porta scopino da parete

Porte balayette

CODE / COEFFICIENT | CODICE /
COEFFICIENTE | CODE / COEFFICIENT

CC M0013CC 2,9

PACKAGING

L: 80 mm
D: 80 mm
H: 380 mm

0,7 kg

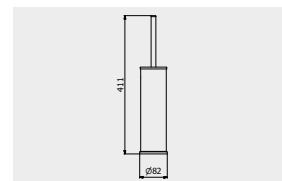

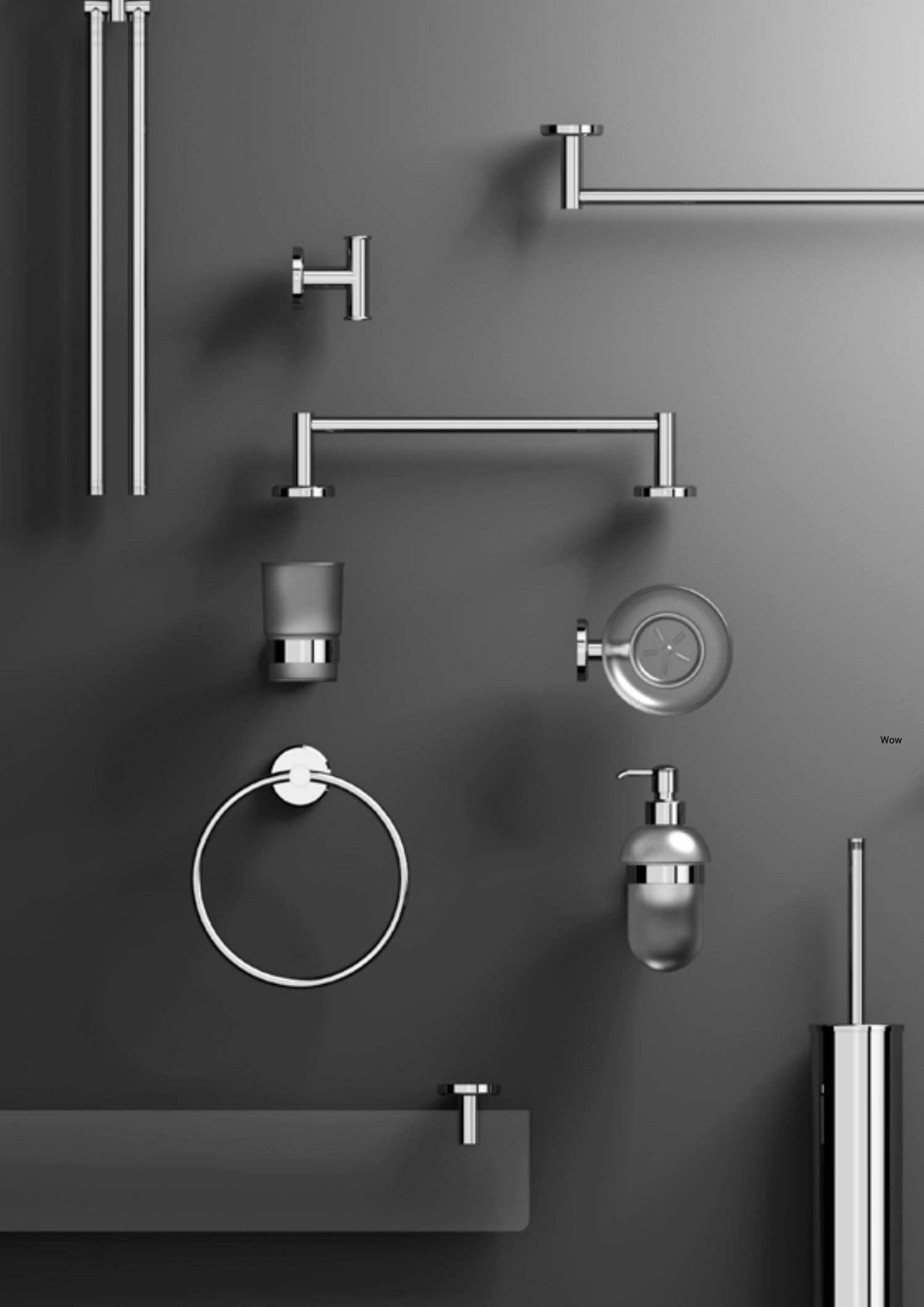

Wow

BIRKIN

Diamonds are a girl's best friends.

I diamanti sono i migliori amici di una ragazza.
Les diamants sont les meilleurs amis d'une fille.

From the name of a 1970s fashion icon, the BIRKIN collection pays tribute to this inspiring muse through a range of products that recall her elegance and strong personality. Birkin offers two selections of spout, simple or engraved with wooden decorations, and three levers, in Swarovski crystal, white Carrara marble or black Marquinia marble, in order to enhance luxurious bathrooms with strong personality through unique and elegant materials.

Dal nome di un'icona dell'eleganza anni Settanta, la collezione BIRKIN omaggia questa musa ispiratrice attraverso una gamma di prodotti che ne richiamano l'eleganza e la decisa personalità. Birkin offre due gamme di bocche, semplice o incisa con decorazioni lignee, e tre leve, in cristallo Swarovski, marmo bianco di Carrara o marmo nero di Marquinia, a impreziosire con materiali unici ed eleganti dei bagni sfarzosi, dotati di forte personalità.

Du nom d'une icône de l'élégance des années 1970, la collection BIRKIN rend hommage à cette muse inspiratrice à travers une gamme de produits qui en rappellent l'élégance et la forte personnalité. Birkin offre deux gammes de becs, simple ou gravée avec des décorations en bois, et trois leviers, en cristal Swarovski, en marbre blanc de Carrare ou en marbre noir de Marquinia, qui embellissent, avec des matériaux uniques, des salles de bain luxueuses à la forte personnalité.



ANTI-LIMESCALE
AREATOR



DOUBLE LEVER



LEAD FREE



ZINC FREE





Birkin

DESIGN
CAMILLA MARIONI



↑ **BR205CC_3**
Monohole washbasin with two handles
Lavabo monoforo con due leve
Mélangeur Lavabo Monotrou

→ **BR205CC_2**
Monohole washbasin with two handles
Lavabo monoforo con due leve
Mélangeur Lavabo Monotrou



Birkin



↑ BR390CC_3
Three holes washbasin set with tall spout
Lavabo tre fori bocca alta
lavabo trois trous bec haut

→ BN390CC_1
Three holes washbasin set with tall spout
Lavabo tre fori bocca alta
lavabo trois trous bec haut



Birkin



↑ BR220CC_1
Monohole bidet mixer
Miscelatore bidet monoforo
Mitigeur bidet

→ BR390CC_2
Three holes washbasin set with tall spout
Lavabo tre fori bocca alta
lavabo trois trous bec haut



ARTICLE | ARTICOLO | ARTICLE

BR205_1



Monohole washbasin mixer complete with drain
 Miscelatore lavabo monoforo completo di scarico automatico
 Mitigeur lavabo complet avec bonde automatique

CODICE / COEFFICIENTE CODE / COEFFICIENT	
● CC	BR205CC_1 13,7
● PL	BR205PL_1 21,9
● SS	BR205SS_1 17,1
● RS	BR205RS_1 20,6
● OS	BR205OS_1 21,9

PACKAGING

📦	L: 353 mm D: 225 mm H: 226 mm
🏷️	3,5 kg

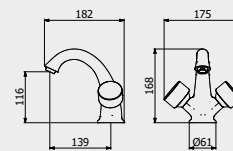

PORTATE | WATER FLOW | DÉBIT D'EAU

1 BAR	2 BAR	3 BAR
10,3 l/m	14,7 l/m	18,2 l/m

ARTICLE | ARTICOLO | ARTICLE

BR205_2



Monohole washbasin mixer complete with drain
 Miscelatore lavabo monoforo completo di scarico automatico
 Mitigeur lavabo complet avec bonde automatique

CODICE / COEFFICIENTE CODE / COEFFICIENT	
● CC	BR205CC_2 13,7
● PL	BR205PL_2 21,9
● SS	BR205SS_2 17,1
● RS	BR205RS_2 20,6
● OS	BR205OS_2 21,9

PACKAGING

📦	L: 353 mm D: 225 mm H: 226 mm
🏷️	3,5 kg

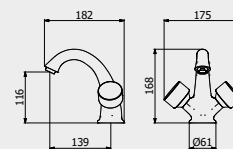

PORTATE | WATER FLOW | DÉBIT D'EAU

1 BAR	2 BAR	3 BAR
10,3 l/m	14,7 l/m	18,2 l/m

ARTICLE | ARTICOLO | ARTICLE

BR205_3



Monohole washbasin mixer complete with drain
 Miscelatore lavabo monoforo completo di scarico automatico
 Mitigeur lavabo complet avec bonde automatique

CODICE / COEFFICIENTE CODE / COEFFICIENT	
● CC	BR205CC_3 15,6
● PL	BR205PL_3 25,0
● SS	BR205SS_3 19,5
● RS	BR205RS_3 23,4
● OS	BR205OS_3 25,0

PACKAGING

📦	L: 353 mm D: 225 mm H: 226 mm
🏷️	3,5 kg

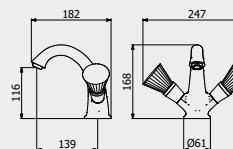

PORTATE | WATER FLOW | DÉBIT D'EAU

1 BAR	2 BAR	3 BAR
10,3 l/m	14,7 l/m	18,2 l/m

Birkin

ARTICLE | ARTICOLO | ARTICLE

BR306_1



Three holes washbasin set with low spout

Lavabo tre fori a bocca bassa completo di scarico automatico

Lavabo trois trous bec bas

CODICE / COEFFICIENTE | CODE /
COEFFICIENT | CODE / COEFFICIENT

●	CC	BR306CC_1	18,3
●	PL	BR306PL_1	29,2
●	SS	BR306SS_1	22,8
●	RS	BR306RS_1	27,4
●	OS	BR306OS_1	29,2

PACKAGING

L: 350 mm
D: 270 mm
H: 35 mm

3,5 kg

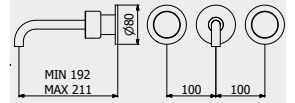

PORTATE | WATER FLOW | DÉBIT D'EAU

1 BAR	2 BAR	3 BAR
2,4 l/m	3,8 l/m	3,8 l/m

ARTICLE | ARTICOLO | ARTICLE

BR306_2



Three holes washbasin set with low spout

Lavabo tre fori a bocca bassa completo di scarico automatico

Lavabo trois trous bec bas

CODICE / COEFFICIENTE | CODE /
COEFFICIENT | CODE / COEFFICIENT

●	CC	BR306CC_2	18,3
●	PL	BR306PL_2	29,2
●	SS	BR306SS_2	22,8
●	RS	BR306RS_2	27,4
●	OS	BR306OS_2	29,2

PACKAGING

L: 350 mm
D: 270 mm
H: 35 mm

3,5 kg

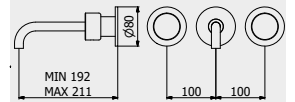

PORTATE | WATER FLOW | DÉBIT D'EAU

1 BAR	2 BAR	3 BAR
2,4 l/m	3,8 l/m	3,8 l/m

ARTICLE | ARTICOLO | ARTICLE

BR306_3



Three holes washbasin set with low spout

Lavabo tre fori a bocca bassa completo di scarico automatico

Lavabo trois trous bec bas

CODICE / COEFFICIENTE | CODE /
COEFFICIENT | CODE / COEFFICIENT

●	CC	BR306CC_3	21,9
●	SS	BR306SS_3	27,3
●	PL	BR306PL_3	35
●	RS	BR306RS_3	32,8
●	OS	BR306OS_3	35,0

PACKAGING

L: 350 mm
D: 270 mm
H: 35 mm

3,5 kg

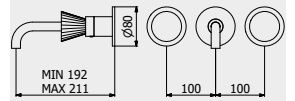

PORTATE | WATER FLOW | DÉBIT D'EAU

1 BAR	2 BAR	3 BAR
2,4 l/m	3,8 l/m	3,8 l/m



ARTICLE | ARTICOLO | ARTICLE

BR390_1



Three holes washbasin set with tall spout

Lavabo tre fori bocca alta completo di scarico automatico

Lavabo trois trous bec haut



CODICE / COEFFICIENTE CODE / COEFFICIENT	
CC	BR390CC_1 18,4
PL	BR390PL_1 29,4
SS	BR390SS_1 23,0
RS	BR390RS_1 27,6
OS	BR390OS_1 29,4

PACKAGING

L: 470 mm
 D: 290 mm
 H: 160 mm

 4,5 kg

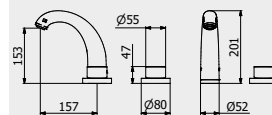

PORTATE | WATER FLOW | DÉBIT D'EAU

1 BAR	2 BAR	3 BAR
11,1 l/m	16 l/m	19,8 l/m

ARTICLE | ARTICOLO | ARTICLE

BR390_2



Three holes washbasin set with tall spout

Lavabo tre fori bocca alta completo di scarico automatico

Lavabo trois trous bec haut



CODICE / COEFFICIENTE CODE / COEFFICIENT	
CC	BR390CC_2 18,4
PL	BR390PL_2 29,4
SS	BR390SS_2 23,0
RS	BR390RS_2 27,6
OS	BR390OS_2 29,4

PACKAGING

L: 470 mm
 D: 290 mm
 H: 160 mm

 4,5 kg

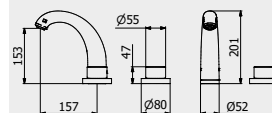

PORTATE | WATER FLOW | DÉBIT D'EAU

1 BAR	2 BAR	3 BAR
11,1 l/m	16 l/m	19,8 l/m

ARTICLE | ARTICOLO | ARTICLE

BR390_3



Three holes washbasin set with tall spout

Lavabo tre fori bocca alta completo di scarico automatico

Lavabo trois trous bec haut



CODICE / COEFFICIENTE CODE / COEFFICIENT	
CC	BR390CC_3 21,1
PL	BR390PL_3 33,8
SS	BR390SS_3 26,4
RS	BR390RS_3 31,7
OS	BR390OS_3 33,8

PACKAGING

L: 470 mm
 D: 290 mm
 H: 160 mm

 4,5 kg

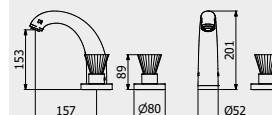

PORTATE | WATER FLOW | DÉBIT D'EAU

1 BAR	2 BAR	3 BAR
11,1 l/m	16 l/m	19,8 l/m

Birkin

ARTICLE | ARTICOLO | ARTICLE

BN390_1



Three holes washbasin set with tall spout

Lavabo tre fori bocca alta completo di scarico automatico

Lavabo trois trous bec haut

CODICE / COEFFICIENTE | CODE /
COEFFICIENT | CODE / COEFFICIENT

●	CC	BN390CC_1	21,3
●	PL	BN390PL_1	34,1
●	SS	BN390SS_1	26,6
●	RS	BN390RS_1	32,0
●	OS	BN390OS_1	34,1

PACKAGING

L: 470 mm
D: 290 mm
H: 160 mm

4,5 kg

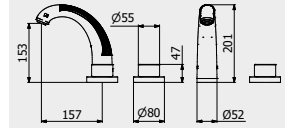

PORTATE | WATER FLOW | DÉBIT D'EAU

1 BAR	2 BAR	3 BAR
11,1 l/m	16 l/m	19,8 l/m

ARTICLE | ARTICOLO | ARTICLE

BN390_2



Three holes washbasin set with tall spout

Lavabo tre fori bocca alta completo di scarico automatico

Lavabo trois trous bec haut

CODICE / COEFFICIENTE | CODE /
COEFFICIENT | CODE / COEFFICIENT

●	CC	BN390CC_2	21,3
●	PL	BN390PL_2	34,1
●	SS	BN390SS_2	26,6
●	RS	BN390RS_2	32,0
●	OS	BN390OS_2	34,1

PACKAGING

L: 470 mm
D: 290 mm
H: 160 mm

4,5 kg

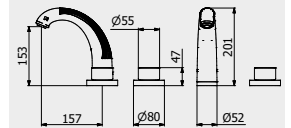

PORTATE | WATER FLOW | DÉBIT D'EAU

1 BAR	2 BAR	3 BAR
11,1 l/m	16 l/m	19,8 l/m

ARTICLE | ARTICOLO | ARTICLE

BN390_3



Three holes washbasin set with tall spout

Lavabo tre fori bocca alta completo di scarico automatico

Lavabo trois trous bec haut

CODICE / COEFFICIENTE | CODE /
COEFFICIENT | CODE / COEFFICIENT

●	CC	BN390CC_3	24,0
●	PL	BN390PL_3	38,4
●	SS	BN390SS_3	30,0
●	RS	BN390RS_3	36,0
●	OS	BN390OS_3	38,4

PACKAGING

L: 470 mm
D: 290 mm
H: 160 mm

4,5 kg

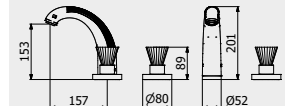

PORTATE | WATER FLOW | DÉBIT D'EAU

1 BAR	2 BAR	3 BAR
11,1 l/m	16 l/m	19,8 l/m



ARTICLE | ARTICOLO | ARTICLE

BR225_1



Monohole bidet mixer complete with drain

Bidet monoforo con scarico automatico

Mitigeur bidet complet avec bonde automatique

CODICE / COEFFICIENTE	CODE / COEFFICIENT	
CC	BR225CC_1	13,5
PL	BR225PL_1	21,6
SS	BR225SS_1	16,9
RS	BR225RS_1	20,3
OS	BR225OS_1	21,6

PACKAGING

L: 353 mm
D: 225 mm
H: 226 mm

3,5kg

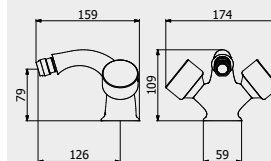

PORTATE | WATER FLOW | DÉBIT D'EAU

1 BAR	2 BAR	3 BAR
10,3 l/m	14,7 l/m	18,2 l/m

ARTICLE | ARTICOLO | ARTICLE

BR225_2



Monohole bidet mixer complete with drain

Bidet monoforo con scarico automatico

Mitigeur bidet complet avec bonde automatique

CODICE / COEFFICIENTE	CODE / COEFFICIENT	
CC	BR225CC_2	13,5
PL	BR225PL_2	21,6
SS	BR225SS_2	16,9
RS	BR225RS_2	20,3
OS	BR225OS_2	21,6

PACKAGING

L: 353 mm
D: 225 mm
H: 226 mm

3,5 kg

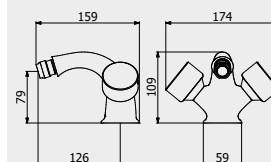

PORTATE | WATER FLOW | DÉBIT D'EAU

1 BAR	2 BAR	3 BAR
10,3 l/m	14,7 l/m	18,2 l/m

ARTICLE | ARTICOLO | ARTICLE

BR225_3



Monohole bidet mixer complete with drain

Bidet monoforo con scarico automatico

Mitigeur bidet complet avec bonde automatique

CODICE / COEFFICIENTE	CODE / COEFFICIENT	
CC	BR225CC_2	15,4
PL	BR225PL_2	24,6
SS	BR225SS_2	19,3
RS	BR225RS_2	23,1
OS	BR225OS_2	24,6

PACKAGING

L: 353 mm
D: 225 mm
H: 226 mm

3,5 kg

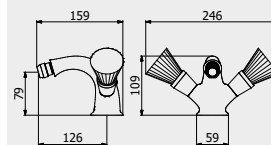

PORTATE | WATER FLOW | DÉBIT D'EAU

1 BAR	2 BAR	3 BAR
10,3 l/m	14,7 l/m	18,2 l/m

Birkin

ARTICLE | ARTICOLO | ARTICLE

BR396_1



Five holes deck mounted bath filler with shower kit

Bordo vasca cinque fori con deviatore e kit doccia

Bain cinq trous avec inverseur et Kit Douche

CODICE / COEFFICIENTE | CODE /
COEFFICIENT | CODE / COEFFICIENT

●	CC	BR396CC_1	33,1
●	SS	BR396SS_1	41,4
●	PL	BR396PL_1	53,0
●	RS	BR396RS_1	49,7
●	OS	BR396OS_1	53,0

PACKAGING

	L: 685 mm
	D: 345 mm
	H: 168 mm
	11,4 kg

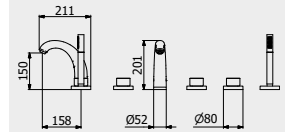

PORTATE | WATER FLOW | DÉBIT D'EAU

1 BAR	2 BAR	3 BAR
13,7 l/m	19,6 l/m	24,1 l/m

ARTICLE | ARTICOLO | ARTICLE

BR396_2



Five holes deck mounted bath filler with shower kit

Bordo vasca cinque fori con deviatore e kit doccia

Bain cinq trous avec inverseur et Kit Douche

CODICE / COEFFICIENTE | CODE /
COEFFICIENT | CODE / COEFFICIENT

●	CC	BR396CC_2	33,1
●	SS	BR396SS_2	41,4
●	PL	BR396PL_2	53,0
●	RS	BR396RS_2	49,7
●	OS	BR396OS_2	53,0

PACKAGING

	L: 685 mm
	D: 345 mm
	H: 168 mm
	11,4 kg

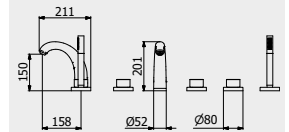

PORTATE | WATER FLOW | DÉBIT D'EAU

1 BAR	2 BAR	3 BAR
13,7 l/m	19,6 l/m	24,1 l/m

ARTICLE | ARTICOLO | ARTICLE

BR396_3



Five holes deck mounted bath filler with shower kit

Bordo vasca cinque fori con deviatore e kit doccia

Bain cinq trous avec inverseur et Kit Douche

CODICE / COEFFICIENTE | CODE /
COEFFICIENT | CODE / COEFFICIENT

●	CC	BR396CC_3	37,5
●	SS	BR396SS_3	46,9
●	PL	BR396PL_3	60,0
●	RS	BR396RS_3	56,3
●	OS	BR396OS_3	60,0

PACKAGING

	L: 685 mm
	D: 345 mm
	H: 168 mm
	11,4 kg

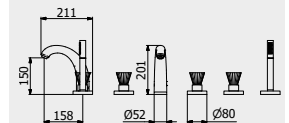

PORTATE | WATER FLOW | DÉBIT D'EAU

1 BAR	2 BAR	3 BAR
13,7 l/m	19,6 l/m	24,1 l/m



ARTICLE | ARTICOLO | ARTICLE

BN396_1



Five holes deck mounted bath filler with shower kit

Bordo vasca cinque fori con deviatore e kit doccia

Bain cinq trous avec inverseur et kit douche

CODICE / COEFFICIENTE CODE / COEFFICIENT	
CC	BN396CC_1 35,0
SS	BN396SS_1 43,8
PL	BN396PL_1 56,0
RS	BN396RS_1 52,5
OS	BN396OS_1 56,0

PACKAGING

L: 685 mm
D: 345 mm
H: 168 mm

11,4 kg

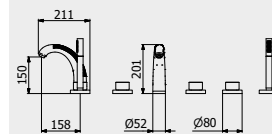

PORTATE | WATER FLOW | DÉBIT D'EAU

1 BAR	2 BAR	3 BAR
13,7 l/m	19,6 l/m	24,1 l/m

ARTICLE | ARTICOLO | ARTICLE

BN396_2



Five holes deck mounted bath filler with shower kit

Bordo vasca cinque fori con deviatore e kit doccia

Bain cinq trous avec inverseur et Kit Douche

CODICE / COEFFICIENTE CODE / COEFFICIENT	
CC	BN396CC_2 35,0
SS	BN396SS_2 43,8
PL	BN396PL_2 56,0
RS	BN396RS_2 52,5
OS	BN396OS_2 56,0

PACKAGING

L: 685 mm
D: 345 mm
H: 168 mm

11,4 kg

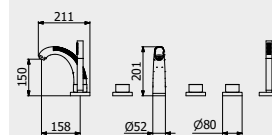

PORTATE | WATER FLOW | DÉBIT D'EAU

1 BAR	2 BAR	3 BAR
13,7 l/m	19,6 l/m	24,1 l/m

ARTICLE | ARTICOLO | ARTICLE

BN396_3



Five holes deck mounted bath filler with shower kit

Bordo vasca cinque fori con deviatore e kit doccia

Bain cinq trous avec inverseur et Kit Douche

CODICE / COEFFICIENTE CODE / COEFFICIENT	
CC	BN396CC_3 40,6
SS	BN396SS_3 50,8
PL	BN396PL_3 65,0
RS	BN396RS_3 60,9
OS	BN396OS_3 65,0

PACKAGING

L: 685 mm
D: 345 mm
H: 168 mm

11,4 kg

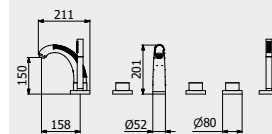

PORTATE | WATER FLOW | DÉBIT D'EAU

1 BAR	2 BAR	3 BAR
13,7 l/m	19,6 l/m	24,1 l/m

Birkin

HERMES / HERMES ELLE

**The true classic will be
current even in a hundred
years.**

Il vero classico è sempre attuale anche dopo cent'anni.
Le vrai classique sera d'actualité même dans cent ans.

True eternal classic of faucet design, Hermes recaptures and enhances the traditional forms of the faucet, providing a familiar decorative element, adaptable to both classic and contemporary settings. The wide range of products, especially in the rich shower section, is completed by two different levers, a more baroque and traditional one, and another with more feminine and delicate features.

Vero classico eterno del design di rubinetti, Hermes riprende e arricchisce le forme tradizionali del rubinetto, fornendo un elemento decorativo familiare, adattabile ad ambienti sia classici che contemporanei. La vasta gamma di prodotti, soprattutto nella ricca sezione doccia, è completata da due differenti leve, dal tratto più barocco e tradizionale o dalle fattezze più femmine e delicate.

Véritable classique du design des robinets, Hermes capture et enrichit les formes traditionnelles du robinet, en fournissant un élément décoratif familier, adaptable tant aux environnements classiques qu'à ceux plus contemporains. La vaste gamme de produits, en particulier dans la riche section douche, est complétée par deux leviers différents, l'un avec une touche plus baroque et traditionnelle, l'autre avec des traits plus féminins et délicats.



KITCHEN
AVAILABLE



DOUBLE
HANDLES



LEAD FREE



ZINC FREE





Hermes

DESIGN
ELIO BREGOLI



- ↑ **HR390CC**
 Three holes washbasin set with tall spout
 Lavabo tre fori bocca alta
 Lavabo trois trous bec haut
- ↙ **HL390II_2**
 Three holes washbasin set with tall spout
 Lavabo tre fori bocca alta
 Lavabo trois trous bec haut
- **HR205CC**
 Monohole washbasin with two handles
 Lavabo monoforo con due leve
 Mélangeur lavabo monotrou









↑ HL393CC_2
Three holes bidet set
 Bidet tre fori con bocca snodabile
 Bidet trois trous

← HR225CC
Monohole bidet with two handles
 Bidet monoforo con due leve
 Mélangeur Bidet monotrou

→ HR250CC
 Wall mounted bath filler with hand shower kit
 Bordo vasca esterno a parete con kit doccia
 Mitigeur Bain/douche Mural avec douchette
 encastrée





- ↖ **HR350CC**
Wall mounted shower mixer with shower kit
Doccia esterno a parete con kit doccia
Mitigeur de douche externe avec flexible et
douchette

- ← **HL199CC**
Shower column with thermostatic
Colonna doccia con termostatico e soffione
Colonne de douche thermostatique

- A Thermostatic valve**
Valvola termostatica
Valve thermostatique
- B Flow control**
Regolazione del flusso
Régulation de débit

- ↗ **HL851CC_2**
Thermostatic shower column with shower kit
Colonna doccia con miscelatore termostatico
e kit doccia
Colonne douche thermostatique et kit douche



Hermes

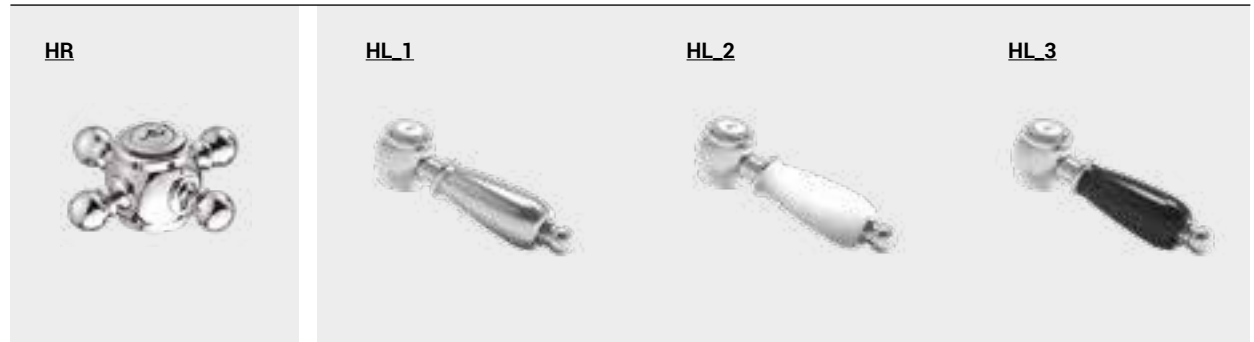

ARTICLE | ARTICOLO | ARTICLE

HR205



Monohole washbasin with two handles complete with drain
 Lavabo monoforo con due leve completo di scarico automatico
 Mélangeur lavabo monotrou complet avec bonde automatique

CODICE / COEFFICIENTE | CODE /
 COEFFICIENT | CODE / COEFFICIENT

● CC	HR205CC	9,8	
● PL	HR205PL	15,7	
● SS	HR205SS	12,3	
● II	HR205II	14,7	
● RS	HR205RS	14,7	
● OS	HR205OS	15,7	
● RR	HR205RR	13,7	
● BB	HR205BB	13,7	

PACKAGING

L: 370 mm
 D: 270 mm
 H: 80 mm

3,1 kg

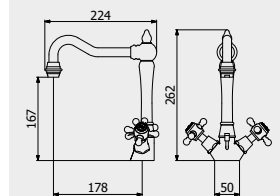

PORTATE | WATER FLOW | DÉBIT D'EAU

1 BAR	2 BAR	3 BAR
10 l/m	14 l/m	11 l/m

ARTICLE | ARTICOLO | ARTICLE

HL205



Monohole washbasin with two handles complete with drain
 Lavabo monoforo con due leve completo di scarico automatico
 Mélangeur lavabo monotrou complet avec bonde automatique

CODICE / COEFFICIENTE | CODE / COEFFICIENT | CODE / COEFFICIENT

● CC	HL205CC_1	HL205CC_2	HL205CC_3	9,8
● PL	HL205PL_1	HL205PL_2	HL205PL_3	15,7
● SS	HL205SS_1	HL205SS_2	HL205SS_3	12,3
● II	HL205II_1	HL205II_2	HL205II_3	14,7
● RS	HL205RS_1	HL205RS_2	HL205RS_3	14,7
● OS	HL205OS_1	HL205OS_2	HL205OS_3	15,7
● RR	HL205RR_1	HL205RR_2	HL205RR_3	13,7
● BB	HL205BB_1	HL205BB_2	HL205BB_3	13,7

PACKAGING

L: 370 mm D: 270 mm H: 80 mm

3,1 kg

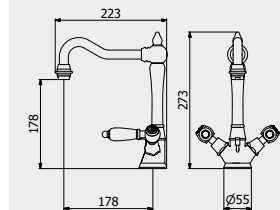

PORTATE | WATER FLOW | DÉBIT D'EAU

1 BAR	2 BAR	3 BAR
10 l/m	14 l/m	11 l/m

ARTICLE | ARTICOLO | ARTICLE

HR306



Wall mounted widespread lavatory faucet

Rubinetto lavabo da incasso

Robinet de lavabo mural

CODICE / COEFFICIENTE | CODE /
 COEFFICIENT | CODE / COEFFICIENT

● CC	HR306CC	11,1	
● PL	HR306PL	17,7	
● SS	HR306SS	13,8	
● II	HR306II	16,6	
● RS	HR306RS	16,6	
● OS	HR306OS	17,7	
● RR	HR306RR	15,5	
● BB	HR306BB	15,5	

PACKAGING

L: 265 mm
 D: 260 mm
 H: 70 mm

1,8 kg

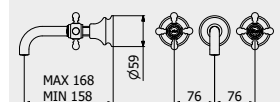

PORTATE | WATER FLOW | DÉBIT D'EAU

1 BAR	2 BAR	3 BAR
9 l/m	13 l/m	15 l/m



ARTICLE | ARTICOLO | ARTICLE

HL306



Wall mounted widespread lavatory faucet
 Rubinetto lavabo da incasso
 Robinet de lavabo mural

CODICE / COEFFICIENTE | CODE / COEFFICIENT | CODE / COEFFICIENT



	CC	PL	SS	II	RS	OS	RR	BB							
HL306CC_1	HL306CC_3	HL306PL_1	HL306PL_3	HL306SS_1	HL306SS_3	HL306II_1	HL306II_3	HL306RS_1	HL306RS_3	HL306OS_1	HL306OS_3	HL306RR_1	HL306RR_3	HL306BB_1	HL306BB_3

PACKAGING

L: 265 mm D: 260 mm H: 70 mm 1,8 kg

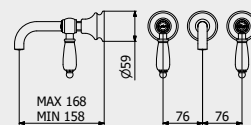

PORTATE | WATER FLOW | DÉBIT D'EAU

1 BAR	2 BAR	3 BAR
9 l/m	13 l/m	15 l/m

ARTICLE | ARTICOLO | ARTICLE

HR307



Wall mounted widespread lavatory faucet with long spout
 Rubinetto lavabo da incasso con bocca lunga
 Robinet de lavabo mural avec bec long



CODICE / COEFFICIENTE | CODE / COEFFICIENT

	CC	PL	SS	II	RS	OS	RR	BB
HR307CC	HR307PL	HR307SS	HR307II	HR307RS	HR307OS	HR307RR	HR307BB	
11,9	19,1	14,9	17,9	17,9	19,1	16,7	16,7	

PACKAGING

L: 265 mm
 D: 260 mm
 H: 70 mm
 1,8 kg

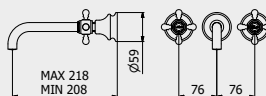

PORTATE | WATER FLOW | DÉBIT D'EAU

1 BAR	2 BAR	3 BAR
8 l/m	11 l/m	13 l/m

ARTICLE | ARTICOLO | ARTICLE

HL307



Wall mounted widespread lavatory faucet with long spout
 Rubinetto lavabo da incasso con bocca lunga
 Robinet de lavabo mural avec bec long



CODICE / COEFFICIENTE | CODE / COEFFICIENT | CODE / COEFFICIENT

	CC	PL	SS	II	RS	OS	RR	BB							
HL307CC_1	HL307CC_3	HL307PL_1	HL307PL_3	HL307SS_1	HL307SS_3	HL307II_1	HL307II_3	HL307RS_1	HL307RS_3	HL307OS_1	HL307OS_3	HL307RR_1	HL307RR_3	HL307BB_1	HL307BB_3

PACKAGING

L: 265 mm D: 260 mm H: 70 mm 1,8 kg

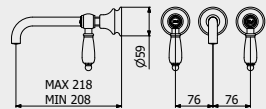

PORTATE | WATER FLOW | DÉBIT D'EAU

1 BAR	2 BAR	3 BAR
8 l/m	11 l/m	13 l/m

ARTICLE | ARTICOLO | ARTICLE

HR308



Wall mounted widespread lavatory faucet with short spout
 Rubinetto lavabo da incasso con bocca corta
 Robinet de lavabo mural avec bec court



CODICE / COEFFICIENTE | CODE / COEFFICIENT

	CC	PL	SS	II	RS	OS	RR	BB
HR308CC	HR308PL	HR308SS	HR308II	HR308RS	HR308OS	HR308RR	HR308BB	
11,9	19,1	14,9	17,9	17,9	19,1	16,7	16,7	

PACKAGING

L: 265 mm
 D: 260 mm
 H: 70 mm
 1,8 kg

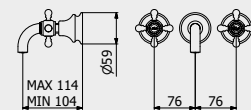

PORTATE | WATER FLOW | DÉBIT D'EAU

1 BAR	2 BAR	3 BAR
8 l/m	11 l/m	13 l/m

Hermes

ARTICLE | ARTICOLO | ARTICLE

HL308



Wall mounted widespread lavatory faucet with short spout
Rubinetto lavabo da incasso con bocca corta
Robinet de lavabo mural avec bec court

CODICE / COEFFICIENTE | CODE / COEFFICIENT | CODE / COEFFICIENT

●	CC	HL308CC_1	HL308CC_3	HL308CC_3	11,9
●	PL	HL308PL_1	HL308PL_3	HL308PL_3	19,1
●	SS	HL308SS_1	HL308SS_3	HL308SS_3	14,9
●	II	HL308II_1	HL308II_3	HL308II_3	17,9
●	RS	HL308RS_1	HL308RS_3	HL308RS_3	17,9
●	OS	HL308OS_1	HL308OS_3	HL308OS_3	19,1
●	RR	HL308RR_1	HL308RR_3	HL308RR_3	16,7
●	BB	HL308BB_1	HL308BB_3	HL308BB_3	16,7

PACKAGING

L: 265 mm D: 260 mm H: 70 mm 1,8 kg

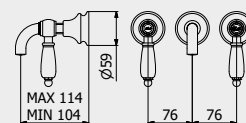

PORTATE | WATER FLOW | DÉBIT D'EAU

1 BAR	2 BAR	3 BAR
8 l/m	11 l/m	13 l/m

ARTICLE | ARTICOLO | ARTICLE

HR390



Three holes washbasin set with tall spout

Lavabo tre fori bocca alta completo di scarico automatico
Lavabo trois trous bec haut

CODICE / COEFFICIENTE | CODE / COEFFICIENT | CODE / COEFFICIENT

●	CC	HR390CC	13,3
●	PL	HR390PL	21,3
●	SS	HR390SS	16,6
●	II	HR390II	20,0
●	RS	HR390RS	20,0
●	OS	HR390OS	21,3
●	RR	HR390RR	18,6
●	BB	HR390BB	18,6

PACKAGING

L: 370 mm
D: 270 mm
H: 80 mm
 3,7 kg

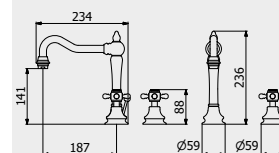

PORTATE | WATER FLOW | DÉBIT D'EAU

1 BAR	2 BAR	3 BAR
9,5 l/m	14 l/m	17 l/m

ARTICLE | ARTICOLO | ARTICLE

HL390



Three holes washbasin set with tall spout

Lavabo tre fori bocca alta completo di scarico automatico
Lavabo trois trous bec haut

CODICE / COEFFICIENTE | CODE / COEFFICIENT | CODE / COEFFICIENT

●	CC	HL390CC_1	HL390CC_2	HL390CC_3	13,3
●	PL	HL390PL_1	HL390PL_2	HL390PL_3	21,3
●	SS	HL390SS_1	HL390SS_2	HL390SS_3	16,6
●	II	HL390II_1	HL390II_2	HL390II_3	20,0
●	RS	HL390RS_1	HL390RS_2	HL390RS_3	20,0
●	OS	HL390OS_1	HL390OS_2	HL390OS_3	21,3
●	RR	HL390RR_1	HL390RR_2	HL390RR_3	18,6
●	BB	HL390BB_1	HL390BB_2	HL390BB_3	18,6

PACKAGING

L: 370 mm D: 270 mm H: 80 mm 3,7 kg

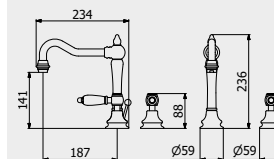

PORTATE | WATER FLOW | DÉBIT D'EAU

1 BAR	2 BAR	3 BAR
9,5 l/m	14 l/m	17 l/m

ARTICLE | ARTICOLO | ARTICLE

HR392



Three holes washbasin set with low spout

Lavabo tre fori a bocca bassa completo di scarico automatico
Lavabo trois trous bec bas

CODICE / COEFFICIENTE | CODE / COEFFICIENT | CODE / COEFFICIENT

●	CC	HR392CC	12,4
●	PL	HR392PL	19,8
●	SS	HR392SS	15,5
●	II	HR392II	18,6
●	RS	HR392RS	18,6
●	OS	HR392OS	19,8
●	RR	HR392RR	17,4
●	BB	HR392BB	17,4

PACKAGING

L: 425 mm
D: 188 mm
H: 98 mm
 2,2 kg

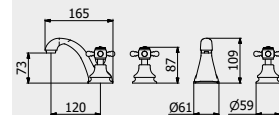

PORTATE | WATER FLOW | DÉBIT D'EAU

1 BAR	2 BAR	3 BAR
9,5 l/m	14 l/m	17 l/m



ARTICLE | ARTICOLO | ARTICLE

HL392



Three holes washbasin set with low spout
Lavabo tre fori a bocca bassa completo di scarico automatico
Lavabo trois trous bec bas

CODICE / COEFFICIENTE | CODE / COEFFICIENT | CODE / COEFFICIENT

	CC	HL392CC_1	HL392CC_2	HL392CC_3	12,4
	PL	HL392PL_1	HL392PL_2	HL392PL_3	19,8
	SS	HL392SS_1	HL392SS_2	HL392SS_3	15,5
	II	HL392II_1	HL392II_2	HL392II_3	18,6
	RS	HL392RS_1	HL392RS_2	HL392RS_3	18,6
	OS	HL392OS_1	HL392OS_2	HL392OS_3	19,8
	RR	HL392RR_1	HL392RR_2	HL392RR_3	17,4
	BB	HL392BB_1	HL392BB_2	HL392BB_3	17,4



PACKAGING

L: 425 mm D: 188 mm H: 98 mm 2,2 kg

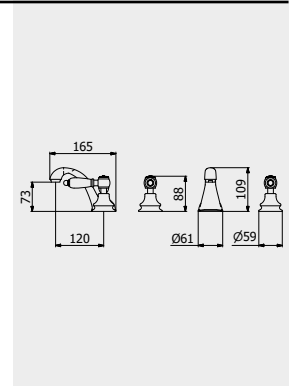

PORTATE | WATER FLOW | DÉBIT D'EAU

1 BAR	2 BAR	3 BAR
9,5 l/m	14 l/m	17 l/m

ARTICLE | ARTICOLO | ARTICLE

HR225



Monohole bidet mixer complete with drain
Miscelatore bidet monoforo completo di scarico automatico
Mitigeur bidet complet avec bonde automatique

CODICE / COEFFICIENTE | CODE / COEFFICIENT | CODE / COEFFICIENT

	CC	HR225CC	9,1
	PL	HR225PL	14,6
	SS	HR225SS	11,4
	II	HR225II	13,7
	RS	HR225RS	13,7
	OS	HR225OS	14,6
	RR	HR225RR	12,7
	BB	HR225BB	12,7



PACKAGING

L: 425 mm D: 188 mm H: 98 mm 2,6 kg

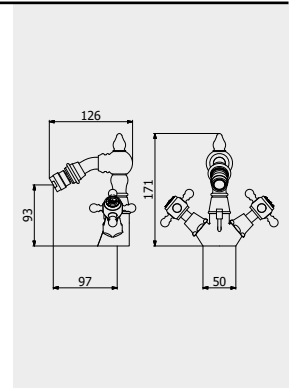

PORTATE | WATER FLOW | DÉBIT D'EAU

1 BAR	2 BAR	3 BAR
10 l/m	14 l/m	17 l/m

ARTICLE | ARTICOLO | ARTICLE

HL225



Monohole bidet mixer complete with drain
Miscelatore bidet monoforo completo di scarico automatico
Mitigeur bidet complet avec bonde automatique

CODICE / COEFFICIENTE | CODE / COEFFICIENT | CODE / COEFFICIENT

	CC	HL225CC_1	HL225CC_2	HL225CC_3	9,1
	PL	HL225PL_1	HL225PL_2	HL225PL_3	14,6
	SS	HL225SS_1	HL225SS_2	HL225SS_3	11,4
	II	HL225II_1	HL225II_2	HL225II_3	13,7
	RS	HL225RS_1	HL225RS_2	HL225RS_3	13,7
	OS	HL225OS_1	HL225OS_2	HL225OS_3	14,6
	RR	HL225RR_1	HL225RR_2	HL225RR_3	12,7
	BB	HL225BB_1	HL225BB_2	HL225BB_3	12,7



PACKAGING

L: 425 mm D: 188 mm H: 98 mm 2,6 kg

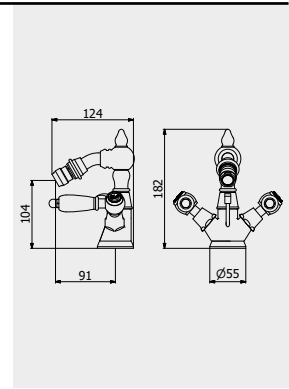

PORTATE | WATER FLOW | DÉBIT D'EAU

1 BAR	2 BAR	3 BAR
10 l/m	14 l/m	17 l/m

ARTICLE | ARTICOLO | ARTICLE

HR393



Three holes bidet set
Bidet tre fori con bocca snodabile completo di scarico automatico
Bidet trois trous

CODICE / COEFFICIENTE | CODE / COEFFICIENT | CODE / COEFFICIENT

	CC	HR393CC	12,7
	PL	HR393PL	20,3
	SS	HR393SS	15,9
	II	HR393II	19,1
	RS	HR393RS	19,1
	OS	HR393OS	20,3
	RR	HR393RR	17,8
	BB	HR393BB	17,8



PACKAGING

L: 425 mm D: 188 mm H: 98 mm 3,4 kg

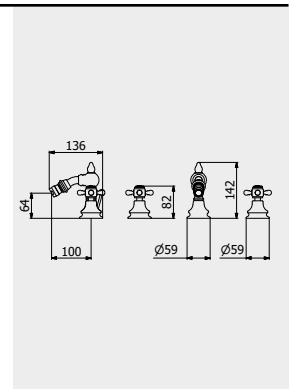

PORTATE | WATER FLOW | DÉBIT D'EAU

1 BAR	2 BAR	3 BAR
9,5 l/m	14 l/m	17 l/m

Hermes

ARTICLE | ARTICOLO | ARTICLE

HL393



Three holes bidet set

Bidet tre fori con bocca snodabile completo di scarico automatico

Bidet trois trous

CODICE / COEFFICIENTE | CODE / COEFFICIENT | CODE / COEFFICIENT

● CC	HL393CC_1	HL393CC_2	HL393CC_3	12,7
● PL	HL393PL_1	HL393PL_2	HL393PL_3	20,3
● SS	HL393SS_1	HL393SS_2	HL393SS_3	15,9
● II	HL393II_1	HL393II_2	HL393II_3	19,1
● RS	HL393RS_1	HL393RS_2	HL393RS_3	19,1
● OS	HL393OS_1	HL393OS_2	HL393OS_3	20,3
● RR	HL393RR_1	HL393RR_2	HL393RR_3	17,8
● BB	HL393BB_1	HL393BB_2	HL393BB_3	17,8

PACKAGING

L: 425mm D: 188 mm H: 98 mm

3,4 kg

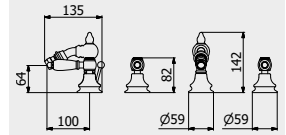

PORTATE | WATER FLOW | DÉBIT D'EAU

1 BAR	2 BAR	3 BAR
9,5 l/m	14 l/m	17 l/m

ARTICLE | ARTICOLO | ARTICLE

HR400



Two holes wall mounted shower

Coppia di rubinetti a parete per doccia una via

Melangeur deux trous douche

CODICE / COEFFICIENTE | CODE / COEFFICIENT | CODE / COEFFICIENT

● CC	HR400CC	5,6
● PL	HR400PL	9,0
● SS	HR400SS	7,0
● II	HR400II	8,4
● RS	HR400RS	8,4
● OS	HR400OS	9,0
● RR	HR400RR	7,8
● BB	HR400BB	7,8

PACKAGING

L: 175 mm
D: 125 mm
H: 90 mm

0,8 kg

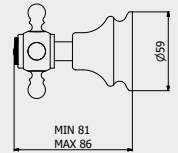

PORTATE | WATER FLOW | DÉBIT D'EAU

1 BAR	2 BAR	3 BAR
26 l/m	38 l/m	46 l/m

ARTICLE | ARTICOLO | ARTICLE

HL400



Two holes wall mounted shower

Coppia di rubinetti a parete per doccia una via

Melangeur deux trous douche

CODICE / COEFFICIENTE | CODE / COEFFICIENT | CODE / COEFFICIENT

● CC	HL400CC_1	HL400CC_2	HL400CC_3	5,6
● PL	HL400PL_1	HL400PL_2	HL400PL_3	9,0
● SS	HL400SS_1	HL400SS_2	HL400SS_3	7,0
● II	HL400II_1	HL400II_2	HL400II_3	8,4
● RS	HL400RS_1	HL400RS_2	HL400RS_3	8,4
● OS	HL400OS_1	HL400OS_2	HL400OS_3	9,0
● RR	HL400RR_1	HL400RR_2	HL400RR_3	7,8
● BB	HL400BB_1	HL400BB_2	HL400BB_3	7,8

PACKAGING

L: 175 mm D: 125 mm H: 90 mm

0,8 kg

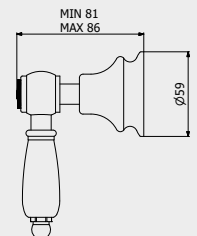

PORTATE | WATER FLOW | DÉBIT D'EAU

1 BAR	2 BAR	3 BAR
26 l/m	38 l/m	46 l/m

ARTICLE | ARTICOLO | ARTICLE

HR410



Three holes wall mounted shower with two ways diverter

Tre rubinetti a parete per doccia con deviatore a due vie

Melangeur trois trous douche avec inverseur deux voies

CODICE / COEFFICIENTE | CODE / COEFFICIENT | CODE / COEFFICIENT

● CC	HR410CC	10,0
● PL	HR410PL	16,0
● SS	HR410SS	12,5
● II	HR410II	15,0
● RS	HR410RS	15,0
● OS	HR410OS	16,0
● RR	HR410RR	14,0
● BB	HR410BB	14,0

PACKAGING

L: 340 mm
D: 180 mm
H: 70 mm

2,6 kg

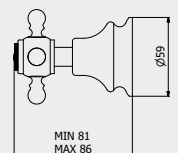

PORTATE | WATER FLOW | DÉBIT D'EAU

1 BAR	2 BAR	3 BAR
12 l/m	15 l/m	19 l/m



ARTICLE | ARTICOLO | ARTICLE

HL410



Three holes wall mounted shower with two ways diverter
 Tre rubinetti a parete per doccia con deviatore a due vie
 Mélangeur trois trous douche avec inverseur deux voies

CODICE / COEFFICIENTE | CODE / COEFFICIENT | CODE / COEFFICIENT

	CC	PL	SS	II	RS	OS	RR	BB
HL410CC_1	HL410CC_2	HL410CC_3	10,0					
HL410PL_1	HL410PL_2	HL410PL_3	16,0					
HL410SS_1	HL410SS_2	HL410SS_3	12,5					
HL410II_1	HL410II_2	HL410II_3	15,0					
HL410RS_1	HL410RS_2	HL410RS_3	15,0					
HL410OS_1	HL410OS_2	HL410OS_3	16,0					
HL410RR_1	HL410RR_2	HL410RR_3	14,0					
HL410BB_1	HL410BB_2	HL410BB_3	14,0					



PACKAGING

L: 340 mm D: 180 mm H: 70 mm 2,6 kg

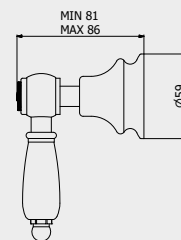

PORTATE | WATER FLOW | DÉBIT D'EAU

1 BAR	2 BAR	3 BAR
12 l/m	15 l/m	19 l/m

ARTICLE | ARTICOLO | ARTICLE

HR199



Shower column with thermostatic valve and showerhead only
 Colonna doccia termostatica solo soffione
 Colonne de douche thermostatique avec seulement tête de douche

CODICE / COEFFICIENTE | CODE / COEFFICIENT

	CC	PL	SS	II	RS	OS	RR	BB
HR199CC	HR199PL	HR199SS	HR199II	HR199RS	HR199OS	HR199RR	HR199BB	
53,0	84,8	66,3	79,5	79,5	84,8	74,2	74,2	

PACKAGING

L: 1003 mm
 D: 520 mm
 H: 130 mm
 14,2 kg

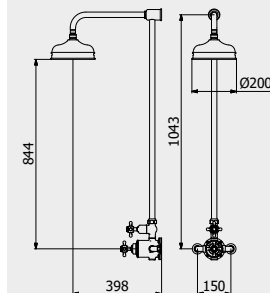

PORTATE | WATER FLOW | DÉBIT D'EAU

1 BAR	2 BAR	3 BAR
23 l/m	33 l/m	40 l/m

ARTICLE | ARTICOLO | ARTICLE

HL199



Shower column with thermostatic valve and showerhead only
 Colonna doccia termostatica solo soffione
 Colonne de douche thermostatique avec seulement tête de douche

CODICE / COEFFICIENTE | CODE / COEFFICIENT | CODE / COEFFICIENT

	CC	PL	SS	II	RS	OS	RR	BB
HL199CC_1	HL199CC_2	HL199CC_3	53,0					
HL199PL_1	HL199PL_2	HL199PL_3	84,8					
HL199SS_1	HL199SS_2	HL199SS_3	66,3					
HL199II_1	HL199II_2	HL199II_3	79,5					
HL199RS_1	HL199RS_2	HL199RS_3	79,5					
HL199OS_1	HL199OS_2	HL199OS_3	84,8					
HL199RR_1	HL199RR_2	HL199RR_3	74,2					
HL199BB_1	HL199BB_2	HL199BB_3	74,2					

PACKAGING

L: 1003 mm D: 520 mm H: 130 mm 14,2 kg

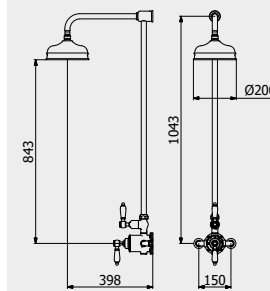

PORTATE | WATER FLOW | DÉBIT D'EAU

1 BAR	2 BAR	3 BAR
23 l/m	33 l/m	40 l/m

Hermes

ARTICLE | ARTICOLO | ARTICLE

HR800



Shower column with mixer and shower kit

Colonna doccia con miscelatore e e kit doccia

Colonne de douche avec mitigeur et kit douche

CODICE / COEFFICIENTE | CODE /
COEFFICIENT | CODE / COEFFICIENT

●	CC	HR800CC	27,5
●	PL	HR800PL	44,0
●	SS	HR800SS	34,4
●	II	HR800II	41,3
●	RS	HR800RS	41,3
●	OS	HR800OS	44,0
●	RR	HR800RR	38,5
●	BB	HR800BB	38,5

PACKAGING

L: 1003 mm
D: 520 mm
H: 130 mm

10 kg

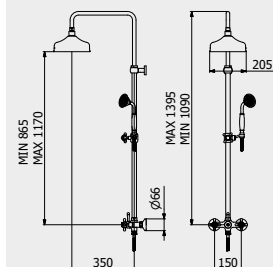

PORTATE | WATER FLOW | DÉBIT D'EAU

1 BAR	2 BAR	3 BAR
8 l/m	12 l/m	14,5 l/m

ARTICLE | ARTICOLO | ARTICLE

HL800



Shower column with mixer and shower kit

Colonna doccia con miscelatore e e kit doccia

Colonne de douche avec mitigeur et kit douche

CODICE / COEFFICIENTE | CODE / COEFFICIENT | CODE / COEFFICIENT

●	CC	HL800CC_1	HL800CC_2	HL800CC_3	27,5
●	PL	HL800PL_1	HL800PL_2	HL800PL_3	44,0
●	SS	HL800SS_1	HL800SS_2	HL800SS_3	34,4
●	II	HL800II_1	HL800II_2	HL800II_3	41,3
●	RS	HL800RS_1	HL800RS_2	HL800RS_3	41,3
●	OS	HL800OS_1	HL800OS_2	HL800OS_3	44,0
●	RR	HL800RR_1	HL800RR_2	HL800RR_3	38,5
●	BB	HL800BB_1	HL800BB_2	HL800BB_3	38,5

PACKAGING

L: 1003 mm D: 520 mm H: 130 mm 10 kg

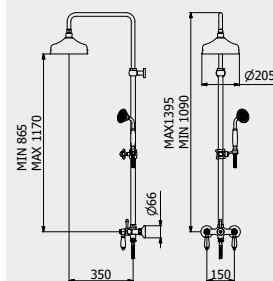

PORTATE | WATER FLOW | DÉBIT D'EAU

1 BAR	2 BAR	3 BAR
8 l/m	12 l/m	14,5 l/m

ARTICLE | ARTICOLO | ARTICLE

HR850



Shower column with bath-tub spout

Colonna doccia con bocca d'erogazione per vasca

Colonne de douche avec bec pour baignoire

CODICE / COEFFICIENTE | CODE /
COEFFICIENT | CODE / COEFFICIENT

●	CC	HR850CC	21,3
●	PL	HR850PL	34,1
●	SS	HR850SS	26,6
●	II	HR850II	32,0
●	RS	HR850RS	32,0
●	OS	HR850OS	34,1
●	RR	HR850RR	29,8
●	BB	HR850BB	29,8

PACKAGING

L: 1003 mm
D: 520 mm
H: 130 mm

14,2 kg

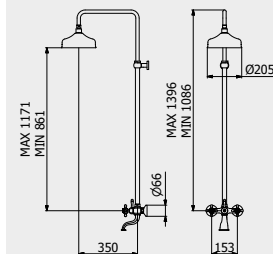

PORTATE | WATER FLOW | DÉBIT D'EAU

1 BAR	2 BAR	3 BAR
8 l/m	12 l/m	14,5 l/m



ARTICLE | ARTICOLO | ARTICLE

HL850



Shower column with bath-tub spout

Colonna doccia con bocca d'erogazione per vasca

Colonne de douche avec bec pour baignoire

CODICE / COEFFICIENTE | CODE / COEFFICIENT | CODE / COEFFICIENT

	CC	PL	SS	II	RS	OS	RR	BB
HL850CC_1	HL850CC_2	HL850CC_3	21,3					
HL850PL_1	HL850PL_2	HL850PL_3	34,1					
HL850SS_1	HL850SS_2	HL850SS_3	26,6					
HL850II_1	HL850II_2	HL850II_3	32,0					
HL850RS_1	HL850RS_2	HL850RS_3	32,0					
HL850OS_1	HL850OS_2	HL850OS_3	34,1					
HL850RR_1	HL850RR_2	HL850RR_3	29,8					
HL850BB_1	HL850BB_2	HL850BB_3	29,8					

PACKAGING

L: 1003 mm D: 520 mm H: 130 mm 14,2 kg

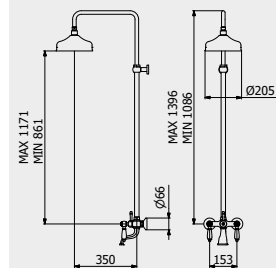

PORTATE | WATER FLOW | DÉBIT D'EAU

1 BAR	2 BAR	3 BAR
8 l/m	12 l/m	14,5 l/m

ARTICLE | ARTICOLO | ARTICLE

HR851



Thermostatic shower column with shower kit

Colonna doccia con miscelatore termostatico e kit doccia

Colonne douche thermostatique et kit douche

CODICE / COEFFICIENTE | CODE / COEFFICIENT | CODE / COEFFICIENT

	CC	PL	SS	II	RS	OS	RR	BB
HR851CC	66,8							
HR851PL	106,9							
HR851SS	83,5							
HR851II	100,2							
HR851RS	100,2							
HR851OS	106,9							
HR851RR	93,5							
HR851BB	93,5							

PACKAGING

L: 1003 mm D: 520 mm H: 130 mm

14,2 kg

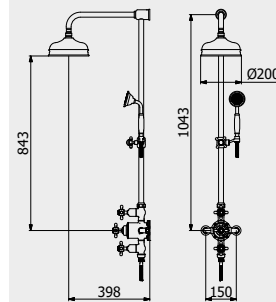

PORTATE | WATER FLOW | DÉBIT D'EAU

1 BAR	2 BAR	3 BAR
26 l/m	36 l/m	46 l/m

ARTICLE | ARTICOLO | ARTICLE

HL851



Thermostatic shower column with shower kit

Colonna doccia con miscelatore termostatico e kit doccia

Colonne douche thermostatique et kit douche

CODICE / COEFFICIENTE | CODE / COEFFICIENT | CODE / COEFFICIENT

	CC	PL	SS	II	RS	OS	RR	BB
HL851CC_1	HL851CC_2	HL851CC_3	66,8					
HL851PL_1	HL851PL_2	HL851PL_3	106,9					
HL851SS_1	HL851SS_2	HL851SS_3	83,5					
HL851II_1	HL851II_2	HL851II_3	100,2					
HL851RS_1	HL851RS_2	HL851RS_3	100,2					
HL851OS_1	HL851OS_2	HL851OS_3	106,9					
HL851RR_1	HL851RR_2	HL851RR_3	93,5					
HL851BB_1	HL851BB_2	HL851BB_3	93,5					

PACKAGING

L: 1003 mm D: 520 mm H: 130 mm 14,2 kg

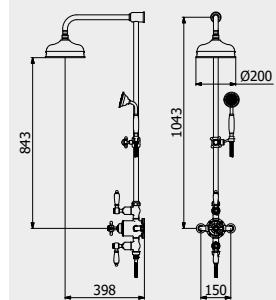

PORTATE | WATER FLOW | DÉBIT D'EAU

1 BAR	2 BAR	3 BAR
26 l/m	36 l/m	46 l/m

Hermes

ARTICLE | ARTICOLO | ARTICLE

HR860



Thermostatic shower column with bath-tub spout

Colonna doccia con miscelatore termostatico e bocca d'erogazione per vasca
Colonne douche thermostatique et kit douche avec bec de remplissage pour baignoire

CODICE / COEFFICIENTE | CODE / COEFFICIENT

●	CC	HR860CC	64,8
●	PL	HR860PL	103,7
●	SS	HR860SS	81,0
●	II	HR860II	97,2
●	RS	HR860RS	97,2
●	OS	HR860OS	103,7
●	RR	HR860RR	90,7
●	BB	HR860BB	90,7

PACKAGING

📦 L: 1003 mm
D: 520 mm
H: 130 mm

🏋️ 14,2 kg

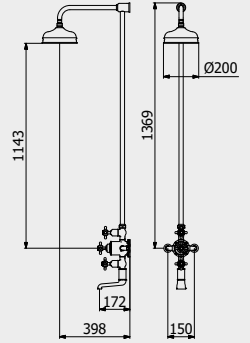

PORTATE | WATER FLOW | DÉBIT D'EAU

1 BAR	2 BAR	3 BAR
23 l/m	33 l/m	40 l/m

ARTICLE | ARTICOLO | ARTICLE

HL860



Thermostatic shower column with bath-tub spout

Colonna doccia con miscelatore termostatico e bocca d'erogazione per vasca
Colonne douche thermostatique et kit douche avec bec de remplissage pour baignoire

CODICE / COEFFICIENTE | CODE / COEFFICIENT | CODE / COEFFICIENT

●	CC	HL860CC_1	HL860CC_2	HL860CC_3	64,8
●	PL	HL860PL_1	HL860PL_2	HL860PL_3	103,7
●	SS	HL860SS_1	HL860SS_2	HL860SS_3	81,0
●	II	HL860II_1	HL860II_2	HL860II_3	97,2
●	RS	HL860RS_1	HL860RS_2	HL860RS_3	97,2
●	OS	HL860OS_1	HL860OS_2	HL860OS_3	103,7
●	RR	HL860RR_1	HL860RR_2	HL860RR_3	90,7
●	BB	HL860BB_1	HL860BB_2	HL860BB_3	90,7

PACKAGING

📦 L: 1003 mm D: 520 mm H: 130 mm

🏋️ 14,2 kg

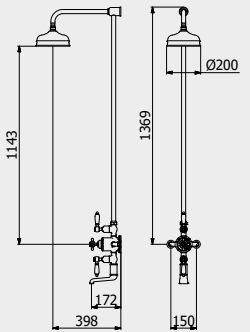

PORTATE | WATER FLOW | DÉBIT D'EAU

1 BAR	2 BAR	3 BAR
23 l/m	33 l/m	40 l/m

ARTICLE | ARTICOLO | ARTICLE

HR250



Wall mounted bath filler complete with hand shower kit

Bordo vasca esterno a parete completo di kit doccia
Mitigeur Bain/douche Mural avec douchette encastree

CODICE / COEFFICIENTE | CODE / COEFFICIENT

●	CC	HR250CC	15,1
●	PL	HR250PL	24,2
●	SS	HR250SS	18,9
●	II	HR250II	22,7
●	RS	HR250RS	22,7
●	OS	HR250OS	24,2
●	RR	HR250RR	21,1
●	BB	HR250BB	21,1

PACKAGING

📦 L: 360 mm
D: 220 mm
H: 150 mm

🏋️ 3,6 kg

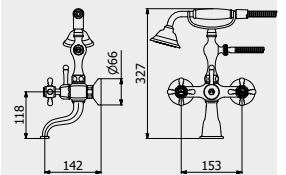

PORTATE | WATER FLOW | DÉBIT D'EAU

1 BAR	2 BAR	3 BAR
23 l/m	32 l/m	37 l/m



ARTICLE | ARTICOLO | ARTICLE

HL250



Wall mounted bath filler complete with hand shower kit
Bordo vasca esterno a parete completo di kit doccia
Mitigeur Bain/douche Mural avec douchette encastrée

CODICE / COEFFICIENTE | CODE / COEFFICIENT | CODE / COEFFICIENT

	CC	PL	SS	II	RS	OS	RR	BB
HL250CC_1	HL250CC_2	HL250CC_3	15,1					
HL250PL_1	HL250PL_2	HL250PL_3	24,2					
HL250SS_1	HL250SS_2	HL250SS_3	18,9					
HL250II_1	HL250II_2	HL250II_3	22,7					
HL250RS_1	HL250RS_2	HL250RS_3	22,7					
HL250OS_1	HL250OS_2	HL250OS_3	24,2					
HL250RR_1	HL250RR_2	HL250RR_3	21,1					
HL250BB_1	HL250BB_2	HL250BB_3	21,1					

PACKAGING

L: 360 mm D: 220 mm H: 150 mm 3,6 kg

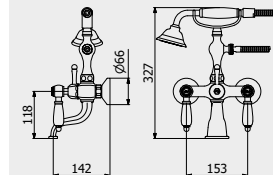

PORTATE | WATER FLOW | DÉBIT D'EAU

1 BAR	2 BAR	3 BAR
23 l/m	32 l/m	37 l/m

ARTICLE | ARTICOLO | ARTICLE

HR350



Wall mounted shower mixer with shower kit
Doccia esterno a parete completo di kit doccia
Mitigeur de douche externe avec flexible et douchette

CODICE / COEFFICIENTE | CODE / COEFFICIENT

	CC	PL	SS	II	RS	OS	RR	BB
HR350CC	7,4							
HR350PL	11,8							
HR350SS	9,3							
HR350II	11,1							
HR350RS	11,1							
HR350OS	11,8							
HR350RR	10,4							
HR350BB	10,4							

PACKAGING

L: 425 mm D: 188 mm H: 98 mm

1,7 kg

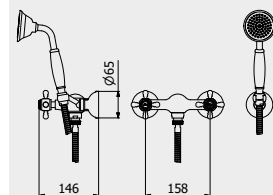

PORTATE | WATER FLOW | DÉBIT D'EAU

1 BAR	2 BAR	3 BAR
14,9 l/m	21,5 l/m	26 l/m

ARTICLE | ARTICOLO | ARTICLE

HL350



Wall mounted shower mixer with shower kit
Doccia esterno a parete completo di kit doccia
Mitigeur de douche externe avec flexible et douchette

CODICE / COEFFICIENTE | CODE / COEFFICIENT | CODE / COEFFICIENT

	CC	PL	SS	II	RS	OS	RR	BB
HL350CC_1	HL350CC_2	HL350CC_3	7,4					
HL350PL_1	HL350PL_2	HL350PL_3	11,8					
HL350SS_1	HL350SS_2	HL350SS_3	9,3					
HL350II_1	HL350II_2	HL350II_3	11,1					
HL350RS_1	HL350RS_2	HL350RS_3	11,1					
HL350OS_1	HL350OS_2	HL350OS_3	11,8					
HL350RR_1	HL350RR_2	HL350RR_3	10,4					
HL350BB_1	HL350BB_2	HL350BB_3	10,4					

PACKAGING

L: 425 mm D: 188 mm H: 98 mm 1,7 kg

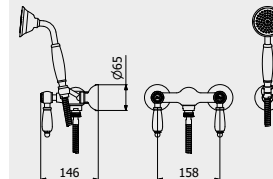

PORTATE | WATER FLOW | DÉBIT D'EAU

1 BAR	2 BAR	3 BAR
14,9 l/m	21,5 l/m	26 l/m

Hermes

ARTICLE | ARTICOLO | ARTICLE

HR396



Five holes deck mounted bath filler with shower kit
Bordo vasca cinque fori con deviatore e kit doccia
Bain/douche cinq trous avec inverseur et Kit Douche

CODICE / COEFFICIENTE | CODE / COEFFICIENT

	CC	PL	SS	II	RS	OS	RR	BB
HR396CC	22,2							
HR396PL	35,5							
HR396SS	27,8							
HR396II	33,3							
HR396RS	33,3							
HR396OS	35,5							
HR396RR	31,1							
HR396BB	31,1							

PACKAGING

L: 455 mm D: 310 mm H: 75 mm

6,1 kg

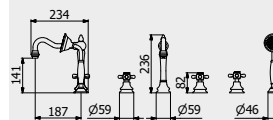

PORTATE | WATER FLOW | DÉBIT D'EAU

1 BAR	2 BAR	3 BAR
9,5 l/m	14 l/m	17 l/m

ARTICLE | ARTICOLO | ARTICLE

HL396



Five holes deck mounted bath filler with shower kit

Bordo vasca cinque fori con deviatore e kit doccia

Bain/douche cinq trous avec inverseur et Kit Douche

CODICE / COEFFICIENTE | CODE / COEFFICIENT | CODE / COEFFICIENT

	CC	PL	SS	II	RS	OS	RR	BB
HL396CC_1	HL396CC_2	HL396CC_3	22,2					
HL396PL_1	HL396PL_2	HL396PL_3	35,5					
HL396SS_1	HL396SS_2	HL396SS_3	27,8					
HL396II_1	HL396II_2	HL396II_3	33,3					
HL396RS_1	HL396RS_2	HL396RS_3	33,3					
HL396OS_1	HL396OS_2	HL396OS_3	35,5					
HL396RR_1	HL396RR_2	HL396RR_3	31,1					
HL396BB_1	HL396BB_2	HL396BB_3	31,1					

PACKAGING

L: 455 mm D: 310 mm H: 75 mm 6,1 kg

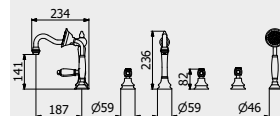

PORTATE | WATER FLOW | DÉBIT D'EAU

1 BAR	2 BAR	3 BAR
9,5 l/m	14 l/m	17 l/m

ARTICLE | ARTICOLO | ARTICLE

HR397



4 holes bath filler with overflow outlet connection, diverter and shower kit

Bordo vasca 4 fori per colonna riempimento con deviatore e kit doccia

Bain/douche 4 trous avec inverseur et Kit Douche pour remplissage ETP

CODICE / COEFFICIENTE | CODE / COEFFICIENT | CODE / COEFFICIENT

	CC	PL	SS	II	RS	OS	RR	BB
HR397CC	HR397PL	HR397SS	HR397II	HR397RS	HR397OS	HR397RR	HR397BB	
15,4	24,6	19,3	23,1	23,1	24,6	21,6	21,6	

PACKAGING

L: 360 mm
D: 220 mm
H: 150 mm

5 kg

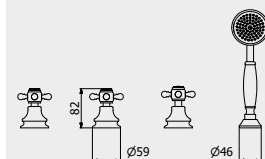

PORTATE | WATER FLOW | DÉBIT D'EAU

1 BAR	2 BAR	3 BAR
19,7 l/m	27,5 l/m	33,1 l/m

ARTICLE | ARTICOLO | ARTICLE

HL397



4 holes bath filler with overflow outlet connection, diverter and shower kit

Bordo vasca 4 fori per colonna riempimento con deviatore e kit doccia

Bain/douche 4 trous avec inverseur et Kit Douche pour remplissage ETP

CODICE / COEFFICIENTE | CODE / COEFFICIENT | CODE / COEFFICIENT

	CC	PL	SS	II	RS	OS	RR	BB
HL397CC_1	HL397CC_2	HL397CC_3	HL397PL_1	HL397PL_2	HL397PL_3	HL397SS_1	HL397SS_2	HL397SS_3
HL397II_1	HL397II_2	HL397II_3	HL397RS_1	HL397RS_2	HL397RS_3	HL397OS_1	HL397OS_2	HL397OS_3
HL397RR_1	HL397RR_2	HL397RR_3	HL397BB_1	HL397BB_2	HL397BB_3	23,1	23,1	23,1
						24,6	21,6	21,6

PACKAGING

L: 360 mm D: 220 mm H: 150 mm 5 kg

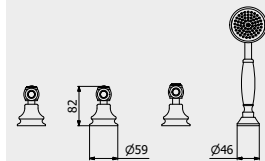

PORTATE | WATER FLOW | DÉBIT D'EAU

1 BAR	2 BAR	3 BAR
19,7 l/m	27,5 l/m	33,1 l/m

ARTICLE | ARTICOLO | ARTICLE

HR398



Five holes wall-mounted bath filler with shower kit

Bordo vasca a parete cinque fori con deviatore e kit doccia

Bain/douche mural cinq trous avec inverseur et Kit Douche

CODICE / COEFFICIENTE | CODE / COEFFICIENT | CODE / COEFFICIENT

	CC	PL	SS	II	RS	OS	RR	BB
HR398CC	HR398PL	HR398SS	HR398II	HR398RS	HR398OS	HR398RR	HR398BB	
16,3	26,1	20,4	24,5	24,5	26,1	22,8	22,8	

PACKAGING

L: 370 mm
D: 270 mm
H: 80 mm

3,6 kg



PORTATE | WATER FLOW | DÉBIT D'EAU

1 BAR	2 BAR	3 BAR
9 l/m	13 l/m	15 l/m



ARTICLE | ARTICOLO | ARTICLE

HL398



Five holes wall-mounted bath filler with shower kit
Bordo vasca a parete cinque fori con deviatore e kit doccia
Bain/douche mural cinq trous avec inverseur et Kit Douche

CODICE / COEFFICIENTE | CODE / COEFFICIENT | CODE / COEFFICIENT

	CC	PL	SS	II	RS	OS	RR	BB
HL398CC_1	HL398CC_2	HL398CC_3	16,3					
HL398PL_1	HL398PL_2	HL398PL_3	26,1					
HL398SS_1	HL398SS_2	HL398SS_3	20,4					
HL398II_1	HL398II_2	HL398II_3	24,5					
HL398RS_1	HL398RS_2	HL398RS_3	24,5					
HL398OS_1	HL398OS_2	HL398OS_3	26,1					
HL398RR_1	HL398RR_2	HL398RR_3	22,8					
HL398BB_1	HL398BB_2	HL398BB_3	22,8					

PACKAGING

L: 370 mm D: 270 mm H: 80 mm 3,6 kg

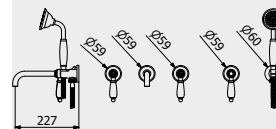

PORTATE | WATER FLOW | DÉBIT D'EAU

1 BAR	2 BAR	3 BAR
19,7 l/m	27,5 l/m	33,1 l/m

ARTICLE | ARTICOLO | ARTICLE

HR320



Wall mounted spout
Bocca d'erogazione a parete
Bec de remplissage mural

CODICE / COEFFICIENTE | CODE / COEFFICIENT

	CC	PL	SS	II	RS	OS	RR	BB
HR320CC	HR320PL	HR320SS	HR320II	HR320RS	HR320OS	HR320RR	HR320BB	
2,1	3,4	2,6	3,2	3,2	3,4	2,9	2,9	

PACKAGING

L: 175 mm
D: 125 mm
H: 90 mm

0,3 kg

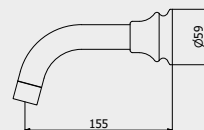

PORTATE | WATER FLOW | DÉBIT D'EAU

1 BAR	2 BAR	3 BAR
9,9 l/m	13,8 l/m	16,8 l/m

ARTICLE | ARTICOLO | ARTICLE

HR321



Short wall mounted spout
Bocca d'erogazione corta a parete
Bec de remplissage mural court

CODICE / COEFFICIENTE | CODE / COEFFICIENT

	CC	PL	SS	II	RS	OS	RR	BB
HR321CC	HR321PL	HR321SS	HR321II	HR321RS	HR321OS	HR321RR	HR321BB	
2,5	4,0	3,1	3,8	3,8	4,0	3,5	3,5	

PACKAGING

L: 175 mm
D: 125 mm
H: 90 mm

0,3 kg

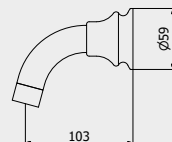

PORTATE | WATER FLOW | DÉBIT D'EAU

1 BAR	2 BAR	3 BAR
9,9 l/m	13,8 l/m	16,8 l/m

ARTICLE | ARTICOLO | ARTICLE

HR322



Long wall mounted spout
Bocca d'erogazione lunga a parete
Bec de remplissage mural long

CODICE / COEFFICIENTE | CODE / COEFFICIENT

	CC	PL	SS	II	RS	OS	RR	BB
HR322CC	HR322PL	HR322SS	HR322II	HR322RS	HR322OS	HR322RR	HR322BB	
2,5	4,0	3,1	3,8	3,8	4,0	3,5	3,5	

PACKAGING

L: 175 mm
D: 125 mm
H: 90 mm

0,3 kg

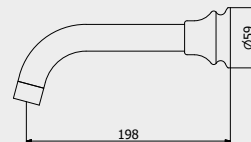

PORTATE | WATER FLOW | DÉBIT D'EAU

1 BAR	2 BAR	3 BAR
9,9 l/m	13,8 l/m	16,8 l/m

Hermes

ARTICOLO | ARTICLE | ARTICLE

HR046



Duplex

Duplex

Duplex

CODICE / COEFFICIENTE | CODE / COEFFICIENT

●	CC	HR046CC	4,0
●	PL	HR046PL	6,4
●	SS	HR046SS	5,0
●	II	HR046II	6,0
●	RS	HR046RS	6,0
●	OS	HR046OS	6,4
●	RR	HR046RR	5,6
●	BB	HR046BB	5,6

PACKAGING

L: 280 mm
D: 130 mm
H: 70 mm

1,2 kg

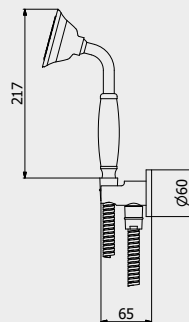

PORTATE | WATER FLOW | DÉBIT D'EAU

1 BAR	2 BAR	3 BAR
15,5 l/m	23,2 l/m	30 l/m

ARTICLE | ARTICOLO | ARTICLE

HR371



Dual Control Kitchen Mixer

Lavello monoforo con due leve

Évier de cuisine

CODICE / COEFFICIENTE | CODE / COEFFICIENT

●	CC	HR371CC	9,2
●	PL	HR371PL	14,7
●	SS	HR371SS	11,5
●	II	HR371II	13,8
●	RS	HR371RS	13,8
●	OS	HR371OS	14,7
●	RR	HR371RR	12,9
●	BB	HR371BB	12,9

PACKAGING

L: 370 mm
D: 270 mm
H: 80 mm

2,6 kg

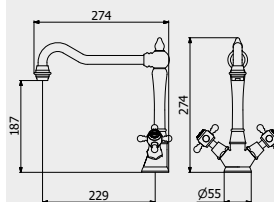

PORTATE | WATER FLOW | DÉBIT D'EAU

1 BAR	2 BAR	3 BAR
9,5 l/m	11 l/m	15 l/m

ARTICLE | ARTICOLO | ARTICLE

HL371



Dual Control Kitchen Mixer

Lavello monoforo con due leve

Évier de cuisine

CODICE / COEFFICIENTE | CODE / COEFFICIENT | CODE / COEFFICIENT

●	CC	HL371CC_1	HL371CC_2	HL371CC_3	9,2
●	PL	HL371PL_1	HL371PL_2	HL371PL_3	14,7
●	SS	HL371SS_1	HL371SS_2	HL371SS_3	11,5
●	II	HL371II_1	HL371II_2	HL371II_3	13,8
●	RS	HL371RS_1	HL371RS_2	HL371RS_3	13,8
●	OS	HL371OS_1	HL371OS_2	HL371OS_3	14,7
●	RR	HL371RR_1	HL371RR_2	HL371RR_3	12,9
●	BB	HL371BB_1	HL371BB_2	HL371BB_3	12,9

PACKAGING

L: 370 mm D: 270 mm H: 80 mm

2,6 kg

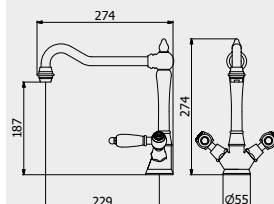

PORTATE | WATER FLOW | DÉBIT D'EAU

1 BAR	2 BAR	3 BAR
9,5 l/m	11 l/m	15 l/m



ARTICLE | ARTICOLO | ARTICLE

HR373



Dual control Wall mounted kitchen mixer

Lavello a parete con due leve

Évier de cuisine encastré au mur

CODICE / COEFFICIENTE | CODE / COEFFICIENT

CC	HR373CC	7,4
PL	HR373PL	11,8
SS	HR373SS	9,3
II	HR373II	11,1
RS	HR373RS	11,1
OS	HR373OS	11,8
RR	HR373RR	10,4
BB	HR373BB	10,4

PACKAGING

L: 425 mm
D: 188 mm
H: 98 mm

1,8 kg

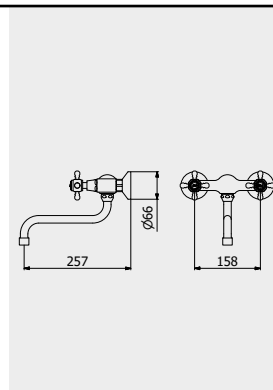

PORTATE | WATER FLOW | DÉBIT D'EAU

1 BAR	2 BAR	3 BAR
10 l/m	15 l/m	18 l/m

ARTICLE | ARTICOLO | ARTICLE

HL373



Dual control Wall mounted kitchen mixer

Lavello a parete con due leve

Évier de cuisine encastré au mur

CODICE / COEFFICIENTE | CODE / COEFFICIENT | CODE / COEFFICIENT

CC	HL373CC_1	HL373CC_2	HL373CC_3	7,4
PL	HL373PL_1	HL373PL_2	HL373PL_3	11,8
SS	HL373SS_1	HL373SS_2	HL373SS_3	9,3
II	HL373II_1	HL373II_2	HL373II_3	11,1
RS	HL373RS_1	HL373RS_2	HL373RS_3	11,1
OS	HL373OS_1	HL373OS_2	HL373OS_3	11,8
RR	HL373RR_1	HL373RR_2	HL373RR_3	10,4
BB	HL373BB_1	HL373BB_2	HL373BB_3	10,4

PACKAGING

L: 425 mm D: 188 mm H: 98 mm

1,8 kg

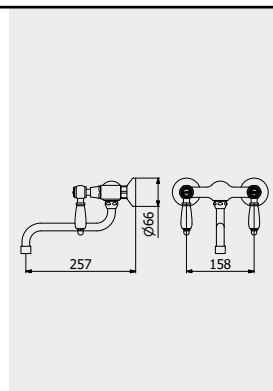

PORTATE | WATER FLOW | DÉBIT D'EAU

1 BAR	2 BAR	3 BAR
10 l/m	15 l/m	18 l/m

HERMES / ACCESSORIES COLLECTION

ARTICLE | ARTICOLO | ARTICLE

HR001

Wall soap-holder

Porta sapone a muro

Porte distributeur de savon encastré



CODICE / COEFFICIENTE	CODE / COEFFICIENT	CODE / COEFFICIENT
CC	HR001CC	2,7
PL	HR001PL	4,3
SS	HR001SS	3,4
II	HR001II	4,1
RS	HR001RS	4,1
OS	HR001OS	4,3
RR	HR001RR	3,8
BB	HR001BB	3,8

CC	HR001CC	2,7
PL	HR001PL	4,3
SS	HR001SS	3,4
II	HR001II	4,1
RS	HR001RS	4,1
OS	HR001OS	4,3
RR	HR001RR	3,8
BB	HR001BB	3,8

PACKAGING

L: 160 mm
 D: 125 mm
 H: 60 mm
 0,4 kg

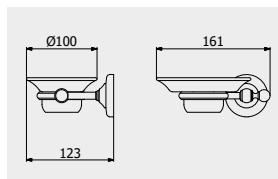

ARTICLE | ARTICOLO | ARTICLE

HR003

Wall toothbrush holder

Bicchiere porta spazzolino a parete

Porte-verre en verre gravé



CODICE / COEFFICIENTE	CODE / COEFFICIENT	CODE / COEFFICIENT
CC	HR003CC	2,6
PL	HR003PL	4,2
SS	HR003SS	3,3
II	HR003II	3,9
RS	HR003RS	3,9
OS	HR003OS	4,2
RR	HR003RR	3,6
BB	HR003BB	3,6

CC	HR003CC	2,6
PL	HR003PL	4,2
SS	HR003SS	3,3
II	HR003II	3,9
RS	HR003RS	3,9
OS	HR003OS	4,2
RR	HR003RR	3,6
BB	HR003BB	3,6

PACKAGING

L: 135 mm
 D: 115 mm
 H: 105 mm
 0,4 kg

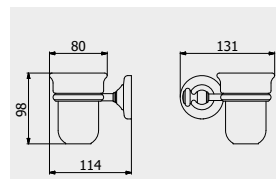

ARTICLE | ARTICOLO | ARTICLE

HR004

Towel holder

Porta salvietta

Porte-serviette



CODICE / COEFFICIENTE	CODE / COEFFICIENT	CODE / COEFFICIENT
CC	HR004CC	3,9
PL	HR004PL	6,2
SS	HR004SS	4,9
II	HR004II	5,9
RS	HR004RS	5,9
OS	HR004OS	6,2
RR	HR004RR	5,5
BB	HR004BB	5,5

CC	HR004CC	3,9
PL	HR004PL	6,2
SS	HR004SS	4,9
II	HR004II	5,9
RS	HR004RS	5,9
OS	HR004OS	6,2
RR	HR004RR	5,5
BB	HR004BB	5,5

PACKAGING

L: 605 mm
 D: 85 mm
 H: 60 mm
 0,6 kg

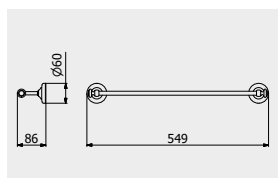

ARTICLE | ARTICOLO | ARTICLE

HR005

Swiveable towel holder

Porta salvietta doppio

Porte-serviettes noeud



CODICE / COEFFICIENTE	CODE / COEFFICIENT	CODE / COEFFICIENT
CC	HR005CC	4,9
PL	HR005PL	7,8
SS	HR005SS	6,1
II	HR005II	7,4
RS	HR005RS	7,4
OS	HR005OS	7,8
RR	HR005RR	6,9
BB	HR005BB	6,9

CC	HR005CC	4,9
PL	HR005PL	7,8
SS	HR005SS	6,1
II	HR005II	7,4
RS	HR005RS	7,4
OS	HR005OS	7,8
RR	HR005RR	6,9
BB	HR005BB	6,9

PACKAGING

L: 440 mm
 D: 60 mm
 H: 60 mm
 0,5 kg

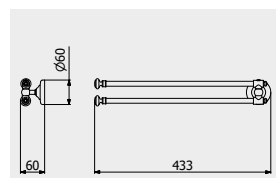

ARTICLE | ARTICOLO | ARTICLE

HR014

Towel holder
Porta salvietta
Porte-serviette

CODICE / COEFFICIENTE	CODE / COEFFICIENT	
CC	HR014CC	3,5
PL	HR014PL	5,6
SS	HR014SS	4,4
II	HR014II	5,3
RS	HR014RS	5,3
OS	HR014OS	5,6
RR	HR014RR	4,9
BB	HR014BB	4,9

PACKAGING

L: 135 mm
D: 115 mm
H: 105 mm

0,4 kg

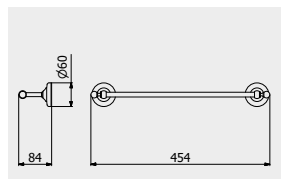

ARTICLE | ARTICOLO | ARTICLE

HR006

Towel holder
Porta salvietta
Porte-serviette

CODICE / COEFFICIENTE	CODE / COEFFICIENT	
CC	HR006CC	3,5
PL	HR006PL	5,6
SS	HR006SS	4,4
II	HR006II	5,3
RS	HR006RS	5,3
OS	HR006OS	5,6
RR	HR006RR	4,9
BB	HR006BB	4,9

PACKAGING

L: 310 mm
D: 85 mm
H: 60 mm

0,4 kg

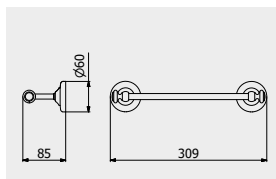

ARTICLE | ARTICOLO | ARTICLE

HR007

Ring Towel holder
Porta salvietta ad anello
Porte-serviette anneau

CODICE / COEFFICIENTE	CODE / COEFFICIENT	
CC	HR007CC	2,5
PL	HR007PL	4,0
SS	HR007SS	3,1
II	HR007II	3,8
RS	HR007RS	3,8
OS	HR007OS	4,0
RR	HR007RR	3,5
BB	HR007BB	3,5

PACKAGING

L: 195 mm
D: 60 mm
H: 215 mm

0,3 kg

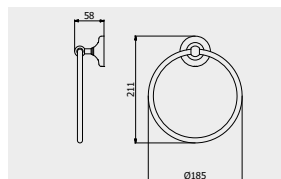

ARTICLE | ARTICOLO | ARTICLE

HR008

Robe Hook
Appendino a parete
Cintre

CODICE / COEFFICIENTE	CODE / COEFFICIENT	
CC	HR008CC	1,4
PL	HR008PL	2,2
SS	HR008SS	1,8
II	HR008II	2,1
RS	HR008RS	2,1
OS	HR008OS	2,2
RR	HR008RR	2,0
BB	HR008BB	2,0

PACKAGING

L: 60 mm
D: 65 mm
H: 70 mm

0,2 kg

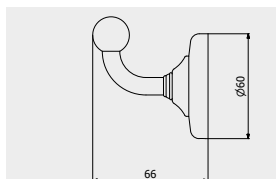

ARTICLE | ARTICOLO | ARTICLE

HR009

Double robe hook
Doppio appendino a paret
Double cintre

CODICE / COEFFICIENTE	CODE / COEFFICIENT	
CC	HR009CC	1,7
PL	HR009PL	2,7
SS	HR009SS	2,1
II	HR009II	2,6
RS	HR009RS	2,6
OS	HR009OS	2,7
RR	HR009RR	2,4
BB	HR009BB	2,4

PACKAGING

L: 80 mm
D: 60 mm
H: 80 mm

0,4 kg

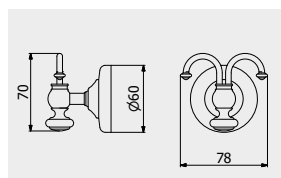

ARTICLE | ARTICOLO | ARTICLE

HR010

Shelf
Mensola
Etager

CODICE / COEFFICIENTE	CODE / COEFFICIENT	
CC	HR010CC	4,5
PL	HR010PL	7,2
SS	HR010SS	5,6
II	HR010II	6,8
RS	HR010RS	6,8
OS	HR010OS	7,2
RR	HR010RR	6,3
BB	HR010BB	6,3

PACKAGING

L: 600 mm
D: 135 mm
H: 65 mm

0,5 kg

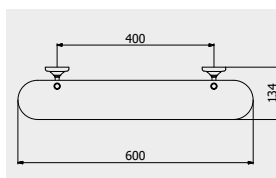

ARTICLE | ARTICOLO | ARTICLE

HR012

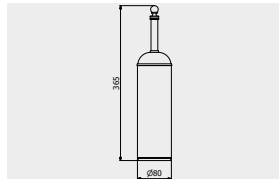

Toilet brush holder

Porta scopino da terra

Porte balayette au sol

CODICE / COEFFICIENTE	CODE / COEFFICIENT	
CC	HR012CC	4,5
PL	HR012PL	7,2
SS	HR012SS	5,6
II	HR012II	6,8
RS	HR012RS	6,8
OS	HR012OS	7,2
RR	HR012RR	6,3
BB	HR012BB	6,3

PACKAGING

L: 80 mm
D: 80 mm
H: 365 mm

0,8 kg

ARTICLE | ARTICOLO | ARTICLE

HR013

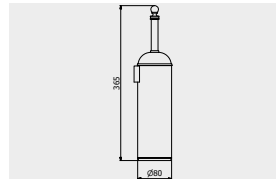

Wall toilet brush holder

Porta scopino da parete

Porte balayette

CODICE / COEFFICIENTE	CODE / COEFFICIENT	
CC	HR013CC	4,8
PL	HR013PL	7,7
SS	HR013SS	6,0
II	HR013II	7,2
RS	HR013RS	7,2
OS	HR013OS	7,7
RR	HR013RR	6,7
BB	HR013BB	6,7

PACKAGING

L: 80 mm
D: 80 mm
H: 365 mm

0,8 kg

ARTICLE | ARTICOLO | ARTICLE

HR011

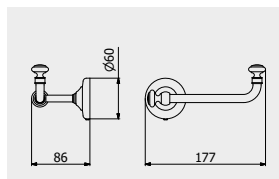

Toilet paper holder

Porta rotolo

Porte rouleaux de toilette

CODICE / COEFFICIENTE	CODE / COEFFICIENT	
CC	HR011CC	2,9
PL	HR011PL	4,6
SS	HR011SS	3,6
II	HR011II	4,4
RS	HR011RS	4,4
OS	HR011OS	4,6
RR	HR011RR	4,1
BB	HR011BB	4,1

PACKAGING

L: 195 mm
D: 85 mm
H: 80 mm

0,5 kg



Hermes

KUSASI / KUSASI SHORT

A small wave that interrupt the straight trait.

Una piccola onda che interferisce interrompendo la linea retta.
Une petite onde qui interfère en interrompant la ligne droite.

A fragmented line, a small wave that interferes interrupting the straight trait: the Kusasi collection represents the contrast between a squared and linear volume and a curvilinear rebel detail, that interrupts its geometry by softening it. The traditional lever can be replaced by a shorter one, accentuating the sinuous wavy features.

Un tratto non lineare, una piccola onda che interferisce interrompendo la linea retta: la collezione Kusasi rappresenta il contrasto tra un volume squadrato e lineare e un particolare curvilineo ribelle, che ne interrompe la geometria, ammorbidendola. La leva tradizionale può essere sostituita da una più corta, ad accentuare il sinuoso tratto ondivago.

Un trait non linéaire, une petite onde qui interfère en interrompant la ligne droite: la collection Kusasi représente le contraste entre un volume carré et linéaire et un détail curviligne rebelle, qui interrompt sa géométrie et l'adoucit. Le levier traditionnel peut être remplacé par un levier plus court, pour accentuer la sinieuse ligne ondulée.



KITCHEN
AVAILABLE



DOUBLE LEVER



LEAD FREE



ZINC FREE





Kusasi

DESIGN
MAURIZIO DURANTI



- ↑ KU200CC
 Monohole washbasin mixer
 Miscelatore lavabo monoforo
 Mitigeur lavabo
- ↙ KS203CC
 Monohole washbasin mixer
 Miscelatore lavabo monoforo
 Mitigeur lavabo
- KU202SS
 Tall monohole washbasin mixer
 Miscelatore lavabo monoforo alto
 Mitigeur lavabo haut







← KU299CC
Monohole free-standing washbasin mixer
Miscelatore lavabo da terra
Mitigeur Lavabo Free standing

↗ KS201CC
Mini monohole washbasin mixer
Miscelatore lavabo monoforo mini
Mitigeur lavabo Mini

→ KU206CC
Wall mounted washbasin mixer
Miscelatore lavabo due fori a parete
Mitigeur lavabo mural



Kusasi



↖ **KU314CC**
Three ways wall shower mixer complete with shower kit
 Miscelatore doccia a parete con deviatore tre vie e doccino integrato
 Mitigeur douche mural trois voies avec inverseur et douchette encastrée

← **KS314CC**
Three ways wall shower mixer complete with shower kit
 Miscelatore doccia a parete con deviatore tre vie e doccino integrato
 Mitigeur douche mural trois voies avec inverseur et douchette encastrée

↗ **KU350CC**
Wall mounted shower mixer with shower kit
 Doccia esterno a parete completo di kit doccia
 Mitigeur de douche externe avec flexible et douchette



Kusasi





← KU399CC
Free-standing bath filler with shower kit
Bordo vasca da terra con kit doccia
Bain douche complet alimentation au sol

↑ KU250CC
Wall mounted bath filler complete with hand shower kit
Bordo vasca esterno a parete completo di kit doccia
Mitigeur Bain/douche Mural avec douchette encastrée

→ KU706CC
Exposed parts for bidet spray complete with mixer
Set di parti esterne per Idroscopino igienico con miscelatore
Partie extérieure pour douchette hygiénique avec mitigeur



Kusasi

LEVER | LEVA | LEVIER

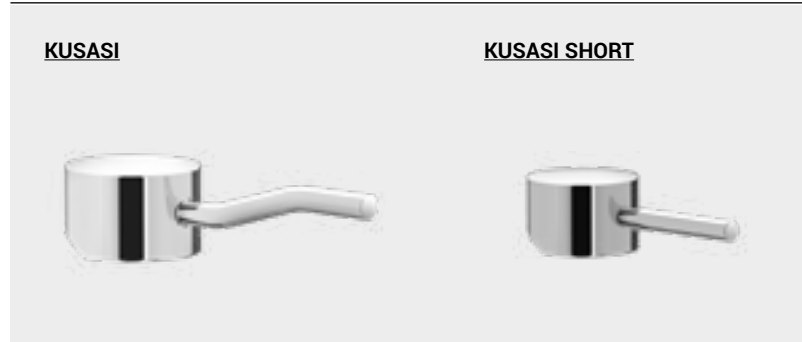

ARTICLE | ARTICOLO | ARTICLE

KU200 / KS200



Monohole washbasin mixer complete with drain

Miscelatore lavabo monoforo completo di scarico automatico

Mitigeur Lavabo complet avec bonde automatique

CODE / COEFFICIENT | CODICE / COEFFICIENTE |
CODE / COEFFICIENT

	CC	KS200CC	KS200CC	5,7
	SS	KU200SS	KS200SS	7,1
	NP	KU200NP	KS200NP	6,8

PACKAGING

 L: 340 mm
D: 180 mm
H: 70 mm

2,0 kg

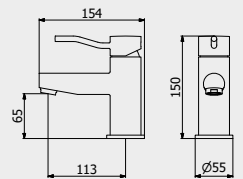

PORTATE | WATER FLOW | DÉBIT D'EAU

1 BAR	2 BAR	3 BAR
9 l/m	12 l/m	15 l/m

ARTICLE | ARTICOLO | ARTICLE

KS201



Mini monohole washbasin mixer complete with drain

Miscelatore lavabo monoforo mini completo di scarico automatico

Mitigeur lavabo Mini complet avec bonde automatique

CODE / COEFFICIENT | CODICE / COEFFICIENTE |
CODE / COEFFICIENT

	CC	KS201CC	5,2
	SS	KS201SS	6,5
	NP	KS201NP	6,2

PACKAGING

 L: 340 mm
D: 180 mm
H: 70 mm

1,7 kg

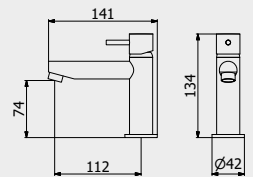

PORTATE | WATER FLOW | DÉBIT D'EAU

1 BAR	2 BAR	3 BAR
9 l/m	12 l/m	15 l/m

ARTICLE | ARTICOLO | ARTICLE

KU202 / KS202



Tall monohole washbasin mixer complete with drain

Miscelatore lavabo alto monoforo completo di scarico automatico

Mitigeur Lavabo haut complet avec bonde automatique

CODE / COEFFICIENT | CODICE / COEFFICIENTE |
CODE / COEFFICIENT

	CC	KU202CC	KS202CC	9,7
	SS <td>KU202SS <td>KS202SS <td>12,1</td> </td></td>	KU202SS <td>KS202SS <td>12,1</td> </td>	KS202SS <td>12,1</td>	12,1
	NP <td>KU202NP <td>KS202NP <td>11,6</td> </td></td>	KU202NP <td>KS202NP <td>11,6</td> </td>	KS202NP <td>11,6</td>	11,6

PACKAGING

 L: 455 mm
D: 310 mm
H: 75 mm

3,5 kg

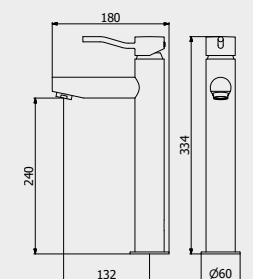

PORTATE | WATER FLOW | DÉBIT D'EAU

1 BAR	2 BAR	3 BAR
9 l/m	12 l/m	15 l/m



ARTICLE | ARTICOLO | ARTICLE

KS203



Mini tall monohole washbasin mixer complete with drain
 Miscelatore lavabo alto monoforo mini completo di scarico automatico
 Mitigeur lavabo Mini haut complet avec bonde automatique

CODE / COEFFICIENT	CODICE / COEFFICIENTE	
CC	KS203CC	8,8
SS	KU203SS	10,9
NP	KU203NP	10,5

PACKAGING

L: 455 mm
 D: 310 mm
 H: 75 mm
 3,3 kg

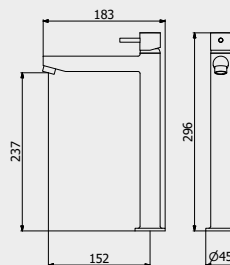

PORTATE | WATER FLOW | DÉBIT D'EAU

1 BAR	2 BAR	3 BAR
7 l/m	10 l/m	13 l/m

ARTICLE | ARTICOLO | ARTICLE

KU206 / KS206



Wall mounted washbasin mixer complete with drain
 Miscelatore lavabo due fori a parete completo di scarico automatico
 Mitigeur lavabo mural complet avec bonde automatique

CODE / COEFFICIENT	CODICE / COEFFICIENTE	
CC	EKU206CC	EKS206CC 8,4
SS	EKU206SS	EKS206SS 10,5
NP	EKU206NP	EKS206NP 10,1

PACKAGING

L: 265 mm
 D: 260 mm
 H: 70 mm
 1,2 kg

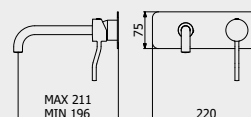

PORTATE | WATER FLOW | DÉBIT D'EAU

1 BAR	2 BAR	3 BAR
7,6 l/m	10,5 l/m	13 l/m

Built-in body to be purchased separately

Corpo incasso da acquistare separatamente
 Corps intégré à acheter séparément



CODICE | CODE | CODE

INC206XXXN_19

COEFFICIENTE | COEFFICIENT | COEFFICIENT

2,9



ARTICLE | ARTICOLO | ARTICLE

KU207 / KS207



Wall mounted washbasin mixer with long spout complete with drain
 Miscelatore lavabo due fori a parete con bocca lunga completo di scarico automatico
 Mitigeur lavabo mural bec long complet avec bonde automatique

CODE / COEFFICIENT	CODICE / COEFFICIENTE	
CC	EKU207CC	EKS207CC 9,6
SS	EKU207SS	EKS207SS 12,0
NP	EKU207NP	EKS207NP 11,5

PACKAGING

L: 265 mm
 D: 260 mm
 H: 70 mm
 1,2 kg

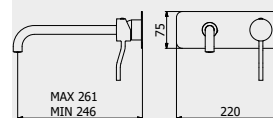

PORTATE | WATER FLOW | DÉBIT D'EAU

1 BAR	2 BAR	3 BAR
7,6 l/m	10,5 l/m	13 l/m

Built-in body to be purchased separately

Corpo incasso da acquistare separatamente
 Corps intégré à acheter séparément



CODICE | CODE | CODE

INC206XXXN_19

COEFFICIENTE | COEFFICIENT | COEFFICIENT

2,9



Kusasi

ARTICLE | ARTICOLO | ARTICLE

KU208 / KS208



Wall mounted washbasin mixer with short spout complete with drain
Miscelatore lavabo due fori a parete con bocca corta completo di scarico
Mitigeur lavabo mural bec court complet avec bonde automatique

CODE / COEFFICIENT | CODICE / COEFFICIENTE |
CODE / COEFFICIENT

	CC	EKU208CC	EKS208CC	9,6
	SS	EKU208SS	EKS208SS	12,0
	NP	EKU208NP	EKS208NP	11,5

PACKAGING

	L: 265 mm D: 260 mm H: 70 mm
	1,2 kg

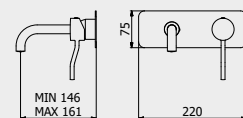

PORTATE | WATER FLOW | DÉBIT D'EAU

1 BAR	2 BAR	3 BAR
7,6 l/m	10,5 l/m	13 l/m

Built-in body to be purchased separately

Corpo incasso da acquistare separatamente

Corps intégré à acheter séparément



CODICE | CODE | CODE

INC206XXXN_19

COEFFICIENTE | COEFFICIENT | COEFFICIENT

2,9



ARTICLE | ARTICOLO | ARTICLE

KU210 / KS210

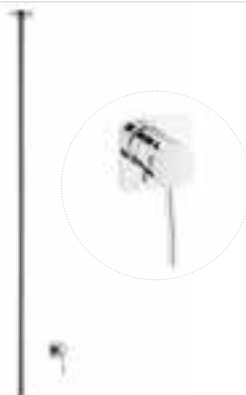

Ceiling spout with wall mounted mixer
Bocca da soffitto con comando remoto ad incasso
Mitigeur lavabo mural avec bec plafond complet avec bonde automatique

CODE / COEFFICIENT | CODICE / COEFFICIENTE |
CODE / COEFFICIENT

	CC	EKU210CC	EKS210CC	27,5
	SS	EKU210SS	EKS210SS	34,4
	NP	EKU210NP	EKS210NP	33,0

PACKAGING

	L: 150 mm D: 190 mm H: 98 mm
	L: 1700 mm Ø: 70 mm

4,5 kg

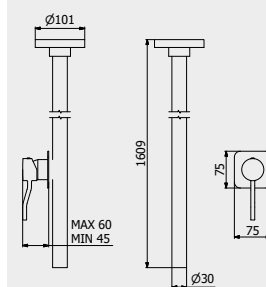

PORTATE | WATER FLOW | DÉBIT D'EAU

1 BAR	2 BAR	3 BAR
4,3 l/m	5,2 l/m	7 l/m

Built-in body to be purchased separately

Corpo incasso da acquistare separatamente

Corps intégré à acheter séparément



CODICE | CODE | CODE

INC300XXXN_19

COEFFICIENTE | COEFFICIENT | COEFFICIENT

1,8

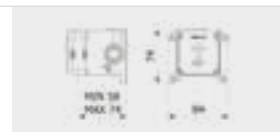

ARTICLE | ARTICOLO | ARTICLE

KU299 / KS299



Monohole free-standing washbasin mixer complete with drain
Miscelatore lavabo da terra completo di scarico automatico
Mitigeur lavabo free standing complet avec bonde automatique

CODE / COEFFICIENT | CODICE / COEFFICIENTE |
CODE / COEFFICIENT

	CC	EKU299CC	EKS299CC	23,1
	SS	EKU299SS	EKS299SS	28,9
	NP	EKU299NP	EKS299NP	27,7

PACKAGING

	L: 782 mm D: 133 mm H: 80 mm
	9,3 kg

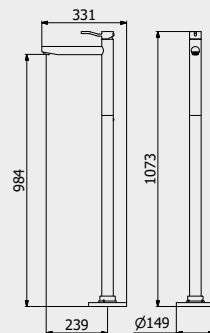

PORTATE | WATER FLOW | DÉBIT D'EAU

1 BAR	2 BAR	3 BAR
10,4 l/m	11,5 l/m	15,5 l/m

Built-in body to be purchased separately
AVAILABLE FROM JANUARY 2020

Corpo incasso da acquistare separatamente
DISPONIBILE DA GENNAIO 2020

Corps intégré à acheter séparément
DISPONIBLE À PARTIR DE JANVIER 2020



CODICE | CODE | CODE

INC399XXXN_19

COEFFICIENTE | COEFFICIENT | COEFFICIENT

2,8

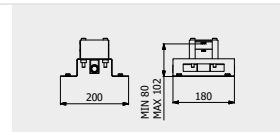

ARTICLE | ARTICOLO | ARTICLE

KU390 / KS390



Three holes washbasin set with tall spout

Lavabo tre fori bocca alta completo di scarico automatico

Lavabo trois trous bec haut

CODE / COEFFICIENT | CODICE / COEFFICIENTE |
CODE / COEFFICIENT

	CC	KS390CC	KS390CC	18,8
	SS	KU390SS	KS390SS	23,4
	NP	KU390NP	KS390NP	22,5

PACKAGING

	L: 455 mm
	D: 310 mm
	H: 75 mm
	5,2 kg

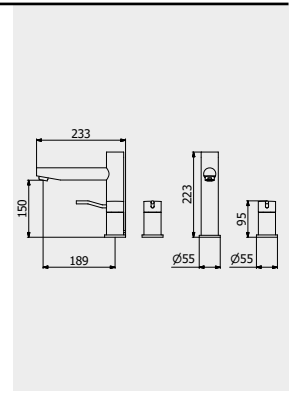

PORTATE | WATER FLOW | DÉBIT D'EAU

1 BAR	2 BAR	3 BAR
10,3 l/m	14,5 l/m	18 l/m

ARTICLE | ARTICOLO | ARTICLE

KU392 / KS392



Three holes washbasin set with low spout

Lavabo tre fori a bocca bassa completo di scarico automatico

Lavabo trois trous bec bas

CODE / COEFFICIENT | CODICE / COEFFICIENTE |
CODE / COEFFICIENT

	CC	KS392CC	KS392CC	15,1
	SS	KU392SS	KS392SS	18,9
	NP	KU392NP	KS392NP	18,2

PACKAGING

	L: 370 mm
	D: 270 mm
	H: 80 mm
	4,2 kg

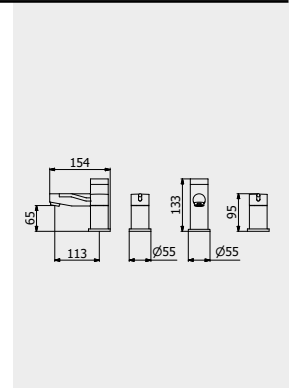

PORTATE | WATER FLOW | DÉBIT D'EAU

1 BAR	2 BAR	3 BAR
9 l/m	13 l/m	18 l/m

ARTICLE | ARTICOLO | ARTICLE

KU220 / KS220



Monohole bidet mixer complete with drain

Miscelatore bidet monoforo completo di scarico automatico

Mitigeur bidet complet avec bonde automatique

CODE / COEFFICIENT | CODICE / COEFFICIENTE |
CODE / COEFFICIENT

	CC	KS220CC	KS220CC	5,7
	SS	KU220SS	KS220SS	7,1
	NP	KU220NP	KS220NP	6,8

PACKAGING

	L: 340 mm
	D: 180 mm
	H: 70 mm
	1,8 kg

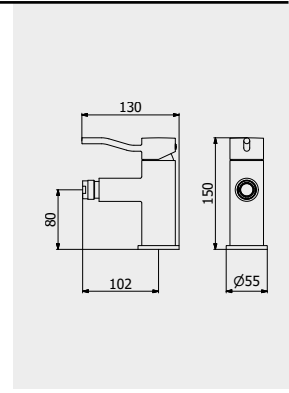

PORTATE | WATER FLOW | DÉBIT D'EAU

1 BAR	2 BAR	3 BAR
9 l/m	12 l/m	15 l/m

ARTICLE | ARTICOLO | ARTICLE

KU300 / KS300



Exposed parts for manual wall mixer

Set di parti esterne per miscelatore a parete ad una via

Partie extérieure pour mitigeur encastré à une voie

CODE / COEFFICIENT | CODICE / COEFFICIENTE |
CODE / COEFFICIENT

CODE / COEFFICIENT	CODICE / COEFFICIENTE	PACKAGING
CC	EKU300CC EKS300CC	2,8
SS	EKU300SS EKS300SS	3,5
NP	EKU300NP EKS300NP	3,4

 L: 150 mm
D: 190 mm
H: 98 mm

1,2 kg

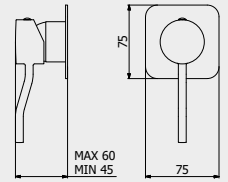

PORTATE | WATER FLOW | DÉBIT D'EAU

1 BAR	2 BAR	3 BAR
11,5 l/m	16,3 l/m	20 l/m

Built-in body to be purchased separately

Corpo incasso da acquistare separatamente

Corps intégré à acheter séparément



CODICE | CODE | CODE

INC300XXXN_19

COEFFICIENTE | COEFFICIENT | COEFFICIENT

1,8

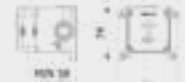

ARTICLE | ARTICOLO | ARTICLE

KU310 / KS310



Exposed parts for manual wall mixer with two ways diverter

Miscelatore doccia a parete con deviatore due vie

Mitigeur douche mural deux voies avec inverseur

CODE / COEFFICIENT | CODICE / COEFFICIENTE |
CODE / COEFFICIENT

CODE / COEFFICIENT	CODICE / COEFFICIENTE	PACKAGING
CC	EKU310CC EKS310CC	5,0
SS	EKU310SS EKS310SS	6,3
NP	EKU310NP EKS310NP	6,0

 L: 150 mm
D: 190 mm
H: 98 mm

1,2 kg

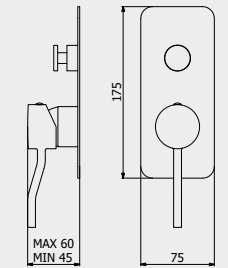

PORTATE | WATER FLOW | DÉBIT D'EAU

1 BAR	2 BAR	3 BAR
9,2 l/m	12,5 l/m	16 l/m

Built-in body to be purchased separately

Corpo incasso da acquistare separatamente

Corps intégré à acheter séparément



CODICE | CODE | CODE

INC310XXXN_19

COEFFICIENTE | COEFFICIENT | COEFFICIENT

3,3

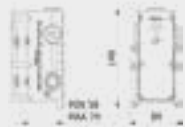

ARTICLE | ARTICOLO | ARTICLE

KU312 / KS312



Exposed parts for manual wall mixer with three ways diverter

Set di parti esterne per miscelatore a parete a tre vie

Mitigeur douche mural trois voies avec inverseur

CODE / COEFFICIENT | CODICE / COEFFICIENTE |
CODE / COEFFICIENT

CODE / COEFFICIENT	CODICE / COEFFICIENTE	PACKAGING
CC	EKU312CC EKS312CC	6,3
SS	EKU312SS EKS312SS	7,9
NP	EKU312NP EKS312NP	7,6

 L: 150 mm
D: 190 mm
H: 98 mm

1,2 kg

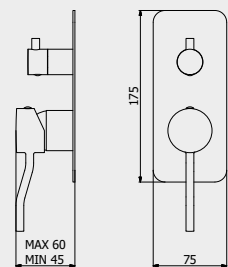

PORTATE | WATER FLOW | DÉBIT D'EAU

1 BAR	2 BAR	3 BAR
8,3 l/m	11,7 l/m	14,3 l/m

Built-in body to be purchased separately

Corpo incasso da acquistare separatamente

Corps intégré à acheter séparément



CODICE | CODE | CODE

INC312XXXN_19

COEFFICIENTE | COEFFICIENT | COEFFICIENT

3,3

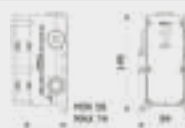

ARTICLE | ARTICOLO | ARTICLE

KU313 / KS313



Exposed parts for manual wall mixer with 2 ways with shower kit
 Set di parti esterne per miscelatore a parete a due vie completo di kit doccia
 Partie extérieure pour mitigeur encastré à deux voies avec douchette

CODE / COEFFICIENT | CODICE / COEFFICIENTE | PACKAGING
 CODE / COEFFICIENT

		EKU313CC	EKS313CC	10,1	L: 370 mm D: 270 mm H: 80 mm 1,9 kg
		EKU313SS	EKS313SS	12,6	
		EKU313NP	EKS313NP	12,1	

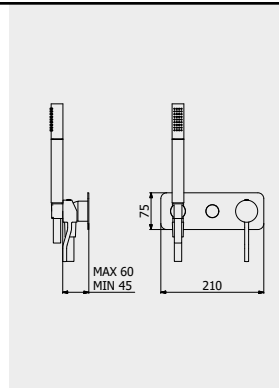

PORTATE | WATER FLOW | DÉBIT D'EAU

1 BAR	2 BAR	3 BAR
10 l/m	14,1 l/m	17,1 l/m

Built-in body to be purchased separately

Corpo incasso da acquistare separatamente

Corps intégré à acheter séparément



CODICE | CODE | CODE

INC313XXXN_19

COEFFICIENTE | COEFFICIENT | COEFFICIENT

3,6

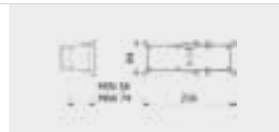

ARTICLE | ARTICOLO | ARTICLE

KU314 / KS314



Exposed parts for manual wall mixer with 3 ways with shower kit
 Set di parti esterne per miscelatore a parete a tre vie completo di kit doccia
 Partie extérieure pour mitigeur encastré à trois voies avec douchette

CODE / COEFFICIENT | CODICE / COEFFICIENTE | PACKAGING
 CODE / COEFFICIENT

		EKU314CC	EKS314CC	11,4	L: 370 mm D: 270 mm H: 80 mm 1,9 kg
		EKU314SS	EKS314SS	14,3	
		EKU314NP	EKS314NP	13,7	

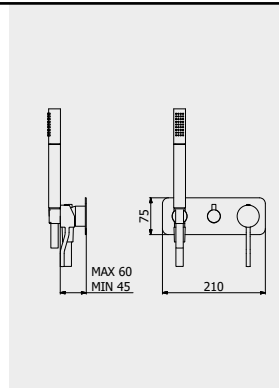

PORTATE | WATER FLOW | DÉBIT D'EAU

1 BAR	2 BAR	3 BAR
9,5 l/m	13,4 l/m	16,9 l/m

Built-in body to be purchased separately

Corpo incasso da acquistare separatamente

Corps intégré à acheter séparément



CODICE | CODE | CODE

INC314XXXN_19

COEFFICIENTE | COEFFICIENT | COEFFICIENT

3,7



ARTICLE | ARTICOLO | ARTICLE

KU250 / KS250



Wall mounted bath filler complete with hand shower kit
 Bordo vasca esterno a parete completo di kit doccia
 Mitigeur Bain/douche Mural avec douchette encastrée

CODE / COEFFICIENT | CODICE / COEFFICIENTE | PACKAGING
 CODE / COEFFICIENT

		KU250CC	KS250CC	8,7	L: 220 mm D: 200 mm H: 150 mm 2,5 kg
		KU250SS	KS250SS	10,9	
		KU250NP	KS250NP	10,4	

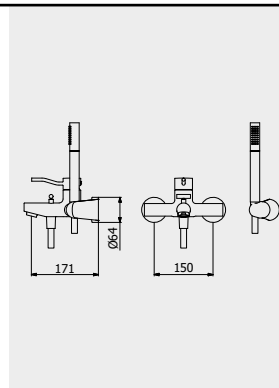

PORTATE | WATER FLOW | DÉBIT D'EAU

1 BAR	2 BAR	3 BAR
10 l/m	14,3 l/m	18 l/m

Kusasi

ARTICLE | ARTICOLO | ARTICLE

KU350 / KS350



Wall mounted shower mixer with shower kit

Doccia esterno a parete completo di kit doccia

Mitigeur de douche externe avec flexible et douchette

CODE / COEFFICIENT | CODICE / COEFFICIENTE |
CODE / COEFFICIENT

●	CC	KU250CC	KS250CC	6,8
●	SS	KU250SS	KS250SS	8,5
●	NP	KU250NP	KS250NP	8,2

PACKAGING

L: 220 mm
D: 200 mm
H: 150 mm

1,7 kg

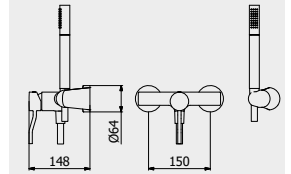

PORTATE | WATER FLOW | DÉBIT D'EAU

1 BAR	2 BAR	3 BAR
10 l/m	15 l/m	18 l/m

ARTICLE | ARTICOLO | ARTICLE

KU396 / KS396



Four holes deck mounted bath filler with shower kit

Bordo vasca quattro fori con deviatore e kit doccia

Bain/douche quatre trous avec inverseur et Kit Douche

CODE / COEFFICIENT | CODICE / COEFFICIENTE |
CODE / COEFFICIENT

●	CC	KU396CC	KS396CC	20,6
●	SS	KU396SS	KS396SS	25,8
●	NP	KU396NP	KS396NP	24,7

PACKAGING

L: 455 mm
D: 310 mm
H: 75 mm

6,2 kg

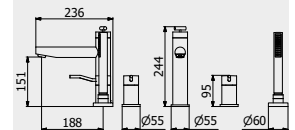

PORTATE | WATER FLOW | DÉBIT D'EAU

1 BAR	2 BAR	3 BAR
11 l/m	15 l/m	20,5 l/m

ARTICLE | ARTICOLO | ARTICLE

KU397 / KS397



4 holes bath filler with overflow outlet connection, diverter and shower kit

Bordo vasca 4 fori per colonna riempimento con deviatore e kit doccia

Bain/douche 4 trous avec inverseur et Kit Douche pour remplissage ETP

CODE / COEFFICIENT | CODICE / COEFFICIENTE |
CODE / COEFFICIENT

●	CC	KU397CC	KS397CC	14,9
●	SS	KU397SS	KS397SS	18,6
●	NP	KU397NP	KS397NP	17,9

PACKAGING

L: 455 mm
D: 310 mm
H: 75 mm

4,7 kg

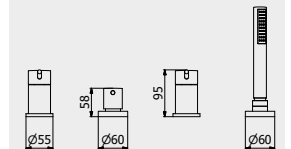

PORTATE | WATER FLOW | DÉBIT D'EAU

1 BAR	2 BAR	3 BAR
10,5 l/m	5 l/m	20,5 l/m



ARTICLE | ARTICOLO | ARTICLE

KU399 / KS399



Free-standing bath filler with shower kit
Bordo vasca da terra con kit doccia
Bain douche complet alimentation au sol

CODICE / COEFFICIENT | CODICE / COEFFICIENTE | **PACKAGING**
CODE / COEFFICIENT

	CC	EKU399CC	EKS399CC	25,3	
	SS	EKU399SS	EKS399SS	31,6	
	NP	EKU399NP	EKS399NP	30,4	7,9 kg

L: 1100 mm
D: 395 mm
H: 150 mm

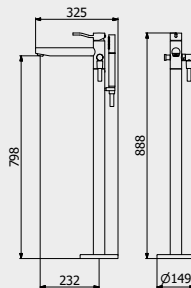

PORTATE | WATER FLOW | DÉBIT D'EAU

1 BAR	2 BAR	3 BAR
11,2 l/m	16 l/m	19,5 l/m

Built-in body to be purchased separately
AVAILABLE FROM JANUARY 2020
Corpo incasso da acquistare separatamente
DISPONIBILE DA GENNAIO 2020
Corps intégré à acheter séparément
DISPONIBLE À PARTIR DE JANVIER 2020



CODICE | CODE | CODE

INC399XXXN_19

COEFFICIENTE | COEFFICIENT | COEFFICIENT

2,8

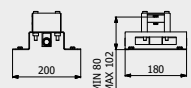

ARTICLE | ARTICOLO | ARTICLE

MT320



Wall mounted spout
Bocca d'erogazione a parete
Bec de remplissage mural

CODICE / COEFFICIENTE | CODE / **PACKAGING**
COEFFICIENT | CODE / COEFFICIENT

	CC	MT320CC	2,1
	NP	MT250NP	2,6
	SS <th>MT320SS</th> <th>2,5</th>	MT320SS	2,5

L: 150 mm
D: 190 mm
H: 98 mm

0,2 kg

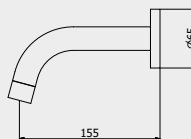

PORTATE | WATER FLOW | DÉBIT D'EAU

1 BAR	2 BAR	3 BAR
9,9 l/m	13,8 l/m	16,8 l/m

ARTICLE | ARTICOLO | ARTICLE

MT321



Short wall mounted spout
Bocca d'erogazione corta a parete
Bec de remplissage mural court

CODICE / COEFFICIENTE | CODE / **PACKAGING**
COEFFICIENT | CODE / COEFFICIENT

	CC	MT321CC	2,5
	PL	MT321PL	3,1
	SS <th>MT321SS</th> <th>3,0</th>	MT321SS	3,0

L: 150 mm
D: 190 mm
H: 98 mm

0,2 kg

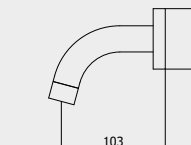

PORTATE | WATER FLOW | DÉBIT D'EAU

1 BAR	2 BAR	3 BAR
9,9 l/m	13,8 l/m	16,8 l/m

ARTICLE | ARTICOLO | ARTICLE

MT322



Long wall mounted spout
Bocca d'erogazione lunga a parete
Bec de remplissage mural long

CODICE / COEFFICIENTE | CODE / **PACKAGING**
COEFFICIENT | CODE / COEFFICIENT

	CC	MT322CC	2,5
	PL	MT322PL	3,1
	SS <th>MT322SS</th> <th>3,0</th>	MT322SS	3,0

L: 150 mm
D: 190 mm
H: 98 mm

0,2 kg



PORTATE | WATER FLOW | DÉBIT D'EAU

1 BAR	2 BAR	3 BAR
9,9 l/m	13,8 l/m	16,8 l/m

Kusasi

ARTICLE | ARTICOLO | ARTICLE

KU706 / KS706



Exposed parts for bidet spray complete with mixer

Set di parti esterne per Idroscopino igienico con miscelatore

Partie extérieure pour douchette hygiénique avec mitigeur

CODE / COEFFICIENT | CODICE / COEFFICIENTE |
CODE / COEFFICIENT

CODE / COEFFICIENT	CODICE / COEFFICIENTE	PACKAGING
CC	EKU706CC	EKS706CC 8,4
SS	EKU706SS	EKS706SS 10,5
NP	EKU706NP	EKS706NP 10,1

PACKAGING
L: 370 mm
D: 270 mm
H: 80 mm

3,1 kg

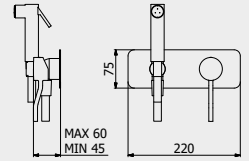

PORTATE | WATER FLOW | DÉBIT D'EAU

1 BAR	2 BAR	3 BAR
2,3 l/m	3,2 l/m	4 l/m

Built-in body to be purchased separately

Corpo incasso da acquistare separatamente

Corps intégré à acheter séparément



CODICE | CODE | CODE

INC206XXXN_19

COEFFICIENTE | COEFFICIENT | COEFFICIENT

2,9



ARTICLE | ARTICOLO | ARTICLE

KU370 / KS370



Single Lever kitchen mixer

Lavello monoforo

Évier de cuisine

CODE / COEFFICIENT | CODICE / COEFFICIENTE |
CODE / COEFFICIENT

CODE / COEFFICIENT	CODICE / COEFFICIENTE	PACKAGING
CC	KU370CC	KS370CC 9,9
SS	KU370SS	KS370SS 12,4
NP	KU370NP	KS370NP 11,9

PACKAGING
L: 455 mm
D: 310 mm
H: 75 mm

3,6 kg

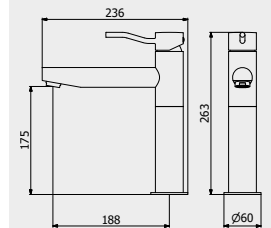

PORTATE | WATER FLOW | DÉBIT D'EAU

1 BAR	2 BAR	3 BAR
9 l/m	13 l/m	16 l/m

ARTICLE | ARTICOLO | ARTICLE

KU385 / KS385



Side lever kitchen mixer

Miscelatore lavello monoforo con leva laterale

Évier de cuisine avec levier latéral

CODE / COEFFICIENT | CODICE / COEFFICIENTE |
CODE / COEFFICIENT

CODE / COEFFICIENT	CODICE / COEFFICIENTE	PACKAGING
CC	KU385CC	KS385CC 7,4
SS	KU385SS	KS385SS 9,3
NP	KU385NP	KS385NP 8,9

PACKAGING
L: 370 mm
D: 270 mm
H: 80 mm

2,4 kg

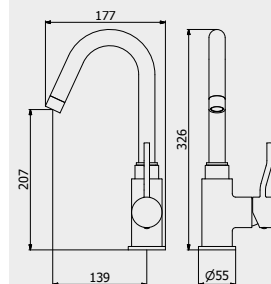

PORTATE | WATER FLOW | DÉBIT D'EAU

1 BAR	2 BAR	3 BAR
9 l/m	12,5 l/m	15 l/m



MODERNA / ACCESSORIES COLLECTION

ARTICLE | ARTICOLO | ARTICLE

MO001

Wall soap-holder

Porta sapone a muro
Porte distributeur de savon encastré

CODE / COEFFICIENT | CODICE /
COEFFICIENTE | CODE / COEFFICIENT

CC **MO001CC** 1,5

PACKAGING

L: 110 mm 0,4 kg
D: 130 mm
H: 50 mm

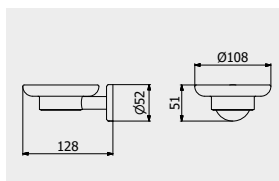

ARTICLE | ARTICOLO | ARTICLE

MO002

Wall soap dispenser holder

Porta dispenser sapone liquido a parete
Porte distributeur de savon en verre gravé

CODE / COEFFICIENT | CODICE /
COEFFICIENTE | CODE / COEFFICIENT

CC **MO002CC** 2,3

PACKAGING

L: 80 mm 0,1 kg
D: 130 mm
H: 180 mm

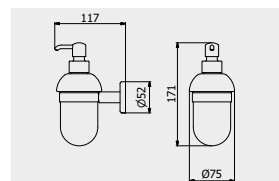

ARTICLE | ARTICOLO | ARTICLE

MO003

Wall toothbrush holder

Bicchiera porta spazzolino a parete
Porte-verre en verre gravé

CODE / COEFFICIENT | CODICE /
COEFFICIENTE | CODE / COEFFICIENT

CC **MO003CC** 1,5

PACKAGING

L: 70 mm 0,4 kg
D: 110 mm
H: 100 mm

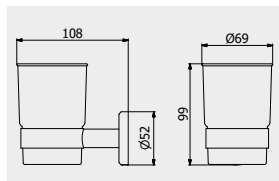

ARTICLE | ARTICOLO | ARTICLE

MO004

Towel holder

Porta salvietta
Porte-serviette

CODE / COEFFICIENT | CODICE /
COEFFICIENTE | CODE / COEFFICIENT

CC **MO004CC** 2,4

PACKAGING

L: 650 mm 0,5 kg
D: 70 mm
H: 50 mm

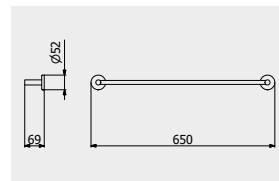

ARTICLE | ARTICOLO | ARTICLE

MO014

Towel holder

Porta salvietta
Porte-serviette

CODE / COEFFICIENT | CODICE /
COEFFICIENTE | CODE / COEFFICIENT

CC **MO014CC** 2,2

PACKAGING

L: 500 mm 0,5 kg
D: 70 mm
H: 50 mm

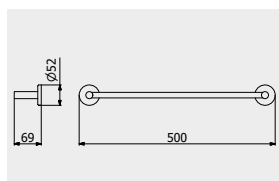

ARTICLE | ARTICOLO | ARTICLE

MO006

Towel holder

Porta salvietta
Porte-serviette

CODE / COEFFICIENT | CODICE /
COEFFICIENTE | CODE / COEFFICIENT

CC **MO006CC** 2,1

PACKAGING

L: 350 mm 0,4 kg
D: 70 mm
H: 50 mm

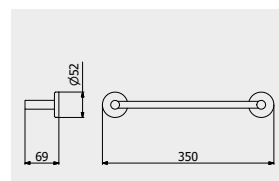

Kusasi

ARTICLE | ARTICOLO | ARTICLE

M0007



Ring Towel holder

Porta salvietta ad anello

Porte-serviette anneau

CODE / COEFFICIENT | CODICE /
COEFFICIENTE | CODE / COEFFICIENT

CC M0007CC 1,6

PACKAGING

L: 180 mm
D: 70 mm
H: 200 mm

0,8 kg

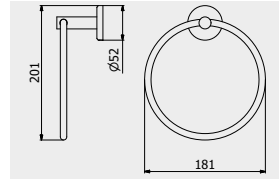

ARTICLE | ARTICOLO | ARTICLE

M0008



Robe Hook

Appendino a parete

Cintre

CODE / COEFFICIENT | CODICE /
COEFFICIENTE | CODE / COEFFICIENT

CC M0008CC 0,9

PACKAGING

L: 50 mm
D: 50 mm
H: 50 mm

0,3 kg

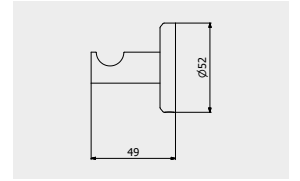

ARTICLE | ARTICOLO | ARTICLE

M0009



Double robe hook

Doppio appendino a parete

Double cintre

CODE / COEFFICIENT | CODICE /
COEFFICIENTE | CODE / COEFFICIENT

CC M0009CC 1,4

PACKAGING

L: 70 mm
D: 70 mm
H: 50 mm

0,1 kg

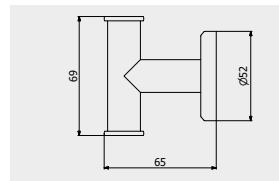

ARTICLE | ARTICOLO | ARTICLE

M0010



Shelf

Mensola

Etagère

CODE / COEFFICIENT | CODICE /
COEFFICIENTE | CODE / COEFFICIENT

CC M0010CC 3,0

PACKAGING

L: 600 mm
D: 140 mm
H: 50 mm

0,3 kg

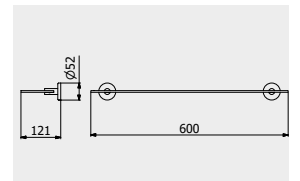

ARTICLE | ARTICOLO | ARTICLE

M0005



Swiveable towel holder

Porta salvietta doppio

Porte-serviette noeud

CODE / COEFFICIENT | CODICE /
COEFFICIENTE | CODE / COEFFICIENT

CC M0005CC 3,5

PACKAGING

L: 430 mm
D: 70 mm
H: 50 mm

0,5 kg

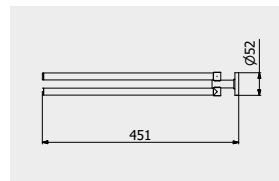

ARTICLE | ARTICOLO | ARTICLE

M0011



Toilet paper holder

Porta rotolo

Porte rouleaux de toilette

CODE / COEFFICIENT | CODICE /
COEFFICIENTE | CODE / COEFFICIENT

CC M0011CC 1,4

PACKAGING

L: 150 mm
D: 70 mm
H: 50 mm

0,2 kg

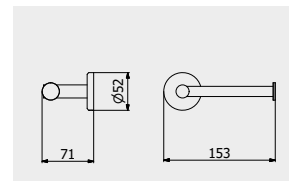

ARTICLE | ARTICOLO | ARTICLE

M0012



Toilet brush holder

Porta scopino da terra

Porte balayette au sol

CODE / COEFFICIENT | CODICE /
COEFFICIENTE | CODE / COEFFICIENT

CC M0012CC 2,5

PACKAGING

L: 80 mm
D: 80 mm
H: 380 mm

0,7 kg

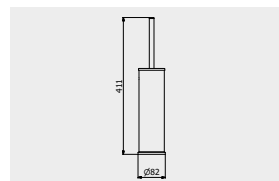

ARTICLE | ARTICOLO | ARTICLE

M0013



Wall toilet brush holder

Porta scopino da parete

Porte balayette

CODE / COEFFICIENT | CODICE /
COEFFICIENTE | CODE / COEFFICIENT

CC M0013CC 2,9

PACKAGING

L: 80 mm
D: 80 mm
H: 380 mm

0,7 kg

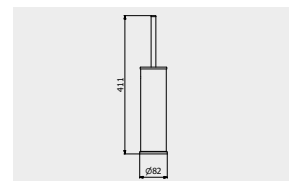



POWA

The smartest and most intuitive electronic faucets we've ever designed.

I rubinetti elettronici più intuitivi e intelligenti che abbiamo mai progettato.

Les robinets électroniques les plus intuitifs et intelligents que nous ayons jamais conçus

The POWA collection offers a range of four electronic mixers, washbasin or wall mounted washbasin, capable of combining technology and high functionality. By reducing water consumption thanks to its infrared electronic controls, the POWA collection makes its faucets perfect for all the public and commercial spaces.

La collezione POWA offre una gamma di quattro miscelatori elettrici, capaci di combinare innovazione tecnologica e alta funzionalità. Riducendo i consumi idrici grazie a comandi elettronici a infrarossi, la collezione POWA rende i suoi rubinetti perfetti per tutti gli spazi, privati e commerciali.

La collection POWA propose une gamme de quatre mitigeurs électroniques, lavabo ou lavabo mural, capables de combiner technologie et haute fonctionnalité. En réduisant la consommation d'eau grâce aux commandes électroniques infrarouges, la collection POWA rend ses robinets parfaits pour tous les espaces, publiques et commerciaux.



LEAD FREE



ZINC FREE



ELECTRONIC



ARTICLE | ARTICOLO | ARTICLE

EL001



Square wall mounted electronic mixer complete with stabilized power supply for mains
Miscelatore lavabo a parete quadro completo di centralina e comando a sensore.
Mitigeur de lavabo mural électroniques carré avec boîtier électrique et commande par capteur.

CODICE / COEFFICIENTE	CODE / COEFFICIENT	
CC	EL001CC	62,5
SS	EL001SS	70,0
BO	EL001BO	70,0
NP	EL001NP	70,0
CF	EL001CF	70,0
CS	EL001CS	70,0
II	EL001II	70,0
IS	EL001IS	70,0
RS	EL001RS	70,0
SR	EL001SR	70,0
OO	EL001OO	70,0
OS	EL001OS	70,0

PACKAGING

L: 240 mm
D: 215 mm
H: 110 mm
2,5 kg

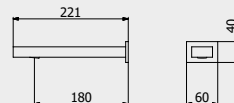

PORTATE | WATER FLOW | DÉBIT D'EAU

1 BAR	2 BAR	3 BAR
4,5 l/m	6 l/m	6 l/m

ARTICLE | ARTICOLO | ARTICLE

EL002



Round wall mounted electronic mixer complete with stabilized power supply for mains
Miscelatore lavabo a parete rotondo completo di centralina e comando a sensore.
Mitigeur de lavabo mural électroniques rond avec boîtier électrique et commande par capteur.

CODICE / COEFFICIENTE	CODE / COEFFICIENT	
CC	EL002CC	62,5

PACKAGING

L: 240 mm
D: 215 mm
H: 110 mm
2,5 kg



PORTATE | WATER FLOW | DÉBIT D'EAU

1 BAR	2 BAR	3 BAR
4,5 l/m	6 l/m	6 l/m

ARTICLE | ARTICOLO | ARTICLE

EL003



Square electronic mixer complete with stabilized power supply for mains
Miscelatore lavabo quadro completo di centralina e comando a sensore.
Mitigeur de lavabo électroniques carré avec boîtier électrique et commande par capteur.

CODICE / COEFFICIENTE	CODE / COEFFICIENT	
CC	EL003CC	62,5
SS	EL003SS	70,0
BO	EL003BO	70,0
NP	EL003NP	70,0
CF	EL003CF	70,0
CS	EL003CS	70,0
II	EL003II	70,0
IS	EL003IS	70,0
RS	EL003RS	70,0
SR	EL003SR	70,0
OO	EL003OO	70,0
OS	EL003OS	70,0

PACKAGING

L: 240 mm
D: 215 mm
H: 110 mm
2,5 kg

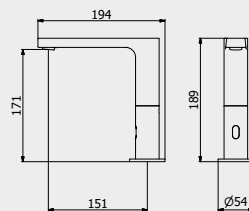

PORTATE | WATER FLOW | DÉBIT D'EAU

1 BAR	2 BAR	3 BAR
4,5 l/m	6 l/m	6 l/m

ARTICLE | ARTICOLO | ARTICLE

EL004



Round electronic mixer complete with stabilized power supply for mains
Miscelatore lavabo tondo completo di centralina e comando a sensore.
Mitigeur de lavabo électroniques rond avec boîtier électrique et commande par capteur.

CODICE / COEFFICIENTE	CODE / COEFFICIENT	
CC	EL004CC	62,5
SS	EL004SS	70,0
BO	EL004BO	70,0
NP	EL004NP	70,0
CF	EL004CF	70,0
CS	EL004CS	70,0
II	EL004II	70,0
IS	EL004IS	70,0
RS	EL004RS	70,0
SR	EL004SR	70,0
OO	EL004OO	70,0
OS	EL004OS	70,0

PACKAGING

L: 240 mm
D: 215 mm
H: 110 mm
2,5 kg

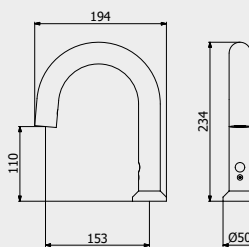

PORTATE | WATER FLOW | DÉBIT D'EAU

1 BAR	2 BAR	3 BAR
4,5 l/m	6 l/m	6 l/m

Powa

BYE BYE

Born to make a difference.

Progettato per fare la differenza.
Conçu pour faire la différence.

The BYE BYE cover plates are a perfect mix of efficiency and refinement. Compatible with the UP720 / Sigma 8 and UP320 / Sigma13 toilet tanks and equipped with a double water flush, they can be customized in thirteen finishes matching the faucet collections, for a flawless elegance in your bathroom.

Le placche BYE BYE sono un mix perfetto di efficacia e ricercatezza. Compatibili con le cassette UP720 / Sigma 8 e UP320 / Sigma13 e dotate di scarico con doppio volume d'acqua, sono personalizzabili in tredici finiture coordinate alle collezioni rubinetti, per un bagno impeccabile nella sua eleganza.

Les plaques BYE BYE allient parfaitement l'efficacité au raffinement. Compatibles avec les réservoirs de chasse UP720 / Sigma 8 et UP320 / Sigma13 et équipées de double débit d'eau, elles peuvent être personnalisées en treize finitions, coordonnées aux collections de robinets, pour une salle de bains d'une élégance impeccable.



DOUBLE WATER
FLUSH



5 mm
THICKNESS



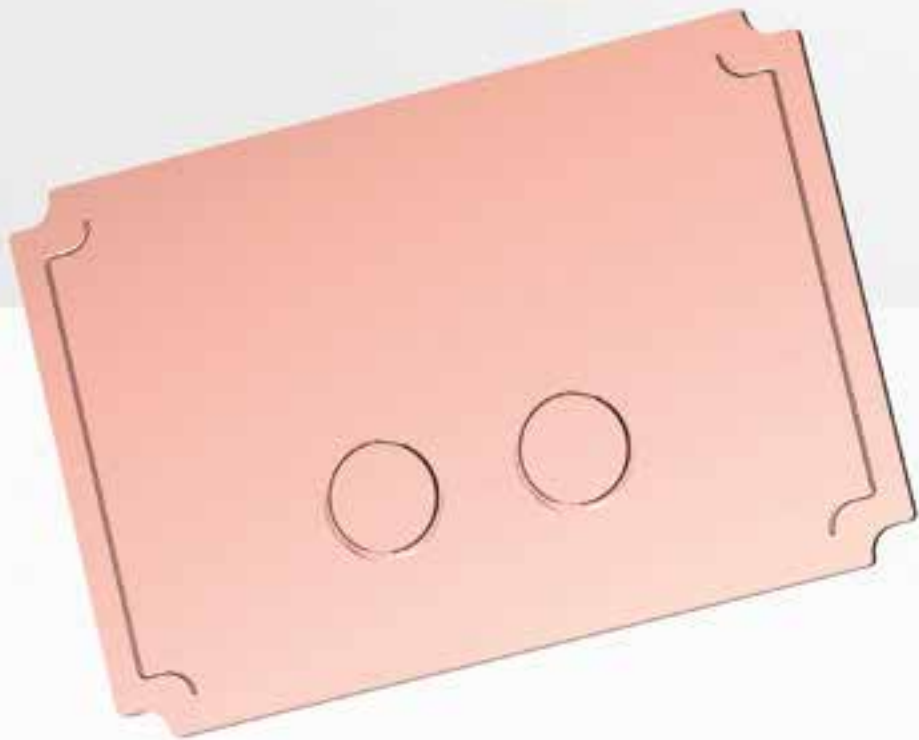
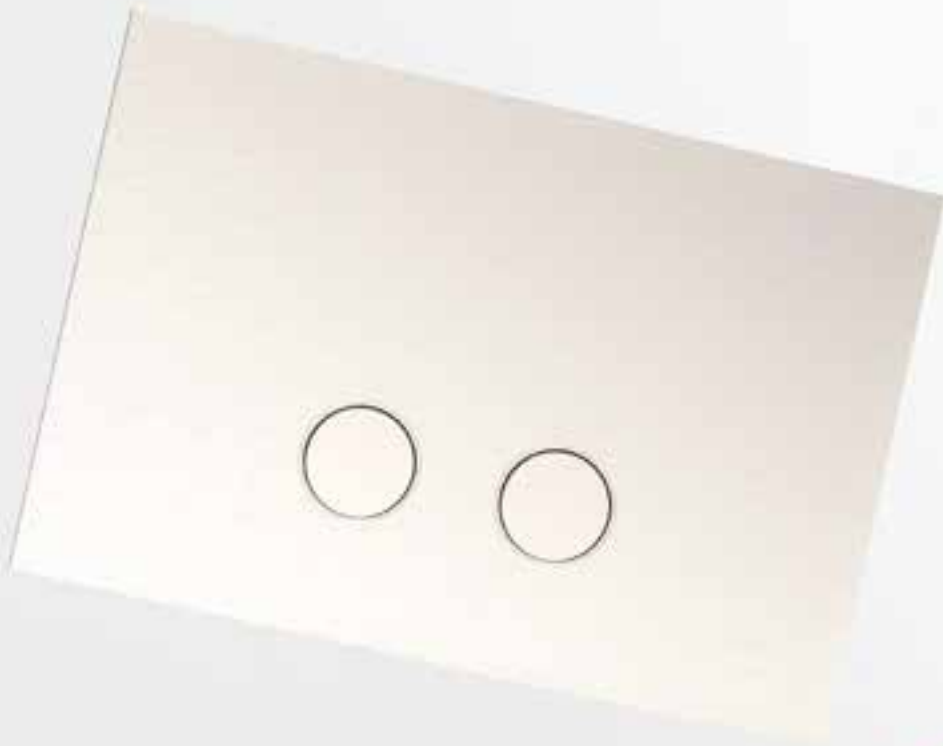

Bye Bye



ARTICLE | ARTICOLO | ARTICLE

BB001



WC cover plate "MODERNA" with double water flush

Placca per cassetta WC "MODERNA" a doppio volume d'acqua.

Plaque de chasse d'eau WC "MODERNA" à double débit d'eau

CODE / COEFFICIENT	CODICE / COEFFICIENTE	
CC	BB001CC	12,5
SS	BB001SS	15,6
ON	BB001ON	12,5
BO	BB001BO	15,0
NP	BB001NP	15,0
CF	BB001CF	18,8
CS	BB001CS	20,0
II	BB001II	18,8
IS	BB001IS	20,0
RS	BB001RS	18,8
SR	BB001SR	20,0
OO	BB001OO	18,8
OS	BB001OS	20,0

PACKAGING

L: 350 mm
D: 270 mm
H: 45 mm

3,2 kg

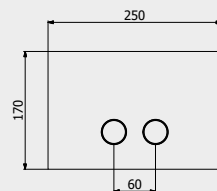

COMPATIBILITY | COMPATIBILITÀ | COMPATIBILITÉ

UP720 / sigma 8

UP320 / Sigma13

ARTICLE | ARTICOLO | ARTICLE

BB002



WC cover plate "HERMES - BIRKIN" with double water flush

Placca per cassetta WC "HERMES - BIRKIN" a doppio volume d'acqua.

Plaque de chasse d'eau WC "HERMES - BIRKIN" à double débit d'eau

CODE / COEFFICIENT	CODICE / COEFFICIENTE	
CC	BB002CC	12,5
PL	BB002PL	20,0
SS	BB002SS	15,6
II	BB002II	18,8
RS	BB002RS	18,8
OS	BB002OS	20,0
RR	BB002RR	17,5
BB	BB002BB	17,5

PACKAGING

L: 350 mm
D: 270 mm
H: 45 mm

3,2 kg

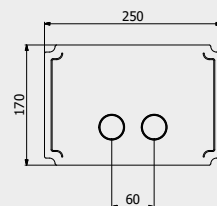

COMPATIBILITY | COMPATIBILITÀ | COMPATIBILITÉ

UP720 / sigma 8

UP320 / Sigma12



Bye Bye

THERMOSTATIQUE



Interactive PDF, you can view the collection directly by clicking on it.

PDF interattivo, per visualizzare direttamente la collezione basta cliccarci sopra.

PDF interactif, vous pouvez voir la collection directement en cliquant dessus.



AQUA
P. 526

SHOWER HEADS



AQUARIVA
P. 580



AQUABEAT
P. 592



ONAIR 2.0
P. 606



DROP
P. 612



MONAMOUR
SHOWER HEADS
+ ARMS
P. 618

SHOWER COLUMNS



WALLPAPER
P. 632



MONAMOUR
P. 638



OTHER
P. 642

SHOWER & CO.



HANDSHOWER
P. 652



DUPLEX
P. 654



SHOWER RAIL
P. 658



BODYJET
P. 660



SHUT OFF
P. 662



STOP VALVES
P. 663



WATER OUTLET
P. 664



BOTTLE TRAP
P. 665

SW

**SHOWER
DOCCIA
DOUCHE**

AQUA

The latest generation thermostatic valves collection.

La collezione di valvole termostatiche di ultima generazione.
La collection de vannes thermostatiques de dernière génération.

AQUA is a new-generation collection of high-performance thermostats, which guarantees perfect temperature and jet controls thanks to its universal built-in bodies. The result of an innovative evolution, Aqua technology is now applied to complex shower systems, through an array of products that ranges from the two-way and three-way diverters to the one-way to five-way independent controls, for an autonomous and simple handling.

AQUA è una collezione di nuova generazione di termostatici ad alte prestazioni, che grazie a corpi incasso universali garantisce il perfetto controllo della temperatura e dei comandi doccia. Frutto di un'evoluzione innovativa, la tecnologia Aqua è ora al servizio di impianti doccia complessi, grazie a una gamma di prodotti che spazia da due deviatori, a due e a tre vie, fino ai comandi indipendenti da una a cinque vie, per una gestione autonoma e semplice.

AQUA est une collection de thermostatiques à haute performance de nouvelle génération qui, grâce à ses corps encastrés universels, assure un contrôle parfait de la température et des commandes douche. Fruit d'une évolution innovante, la technologie Aqua est à présent au service d'installations hydrauliques complexes, grâce à une gamme de produits allant de deux déviateurs, bidirectionnel et tridirectionnel, jusqu'aux commandes indépendants d'un à cinq voies, pour une gestion autonome et simple.



LEAD FREE



ZINC FREE





Features.

Caratteristiche.
Caractéristiques.

1 HIGH FLOW

High flow 3/4" thermostatic cartridge.
Flow rate: 45 liters per minute at 3 bars.

ALTA PORTATA

Cartuccia termostatica 3-4" ad alta portata.
Velocità del flusso: 45 litri al minuto a 3 bar.

HAUT DÉBIT

Cartouche thermostatique 3-4" à débit élevé.
Vitesse du débit: 45 litres par minute à 3 bars.

3 REVERSIBLE

Reversible service check valves with filters and improved stop mechanism.

REVERSIBILE

Valvole di ritegno reversibili con filtri e meccanismo di bloccaggio ottimizzati.

RÉVERSIBLE

Clapets de retenue réversibles avec filtres et mécanisme de blocage perfectionné.

5 SHUTOFF VALVE

Shut-off valve outlets: connections right, left or both sides simultaneously.

VALVOLA DI ARRESTO

Prese della valvola di arresto: attacco a destra, sinistra o sui due lati contemporaneamente.

VANNE D'ARRÊT

Prises de la vanne d'arrêt: à droite, à gauche ou des deux côtés simultanément.

2 UNIVERSAL

Universal inlets for 1/2" and 3/4" connections (built-in adaptors: female threads for 1/2" connections and male threads for 3/4")

UNIVERSALE

Prese universali per attacchi da 1-2" e 3-4" (adattatori a incasso: connettore femmina per attacchi da 1-2" e maschio per 3-4").

UNIVERSEL

Prises universelles pour connexions de 1-2" et 3-4" (adaptateurs encastrés: connecteur femelle de 1-2" et connecteur mâle de 3-4")

4 FINISHES

European made nickel plated solid brass rough and cartridges

FINITURE

Cartucce in ottone massiccio grezzo nichelato di fabbricazione Europea.

FINITIONS

Cartouches en laiton nickelé brut fabriquées en Europe.

6 REMOVABLE

Removable plug at the top for an extra independent shut-off valve connection.

RIMOVIBILE

Spina rimovibile nella parte superiore, per un attacco della valvola di arresto ultra indipendente.

AMOVIBLE

Fiche amovible dans la partie supérieure, pour une jonction extra indépendant de la vanne d'arrêt.







One solution for every shower.

Una soluzione per ogni doccia.
 Une solution pour chaque douche.



Thermostatic valve
1 WAY FREE

Valvola
 termostatica con 1
 via indipendente

Valve
 thermostatique par
 1 voie d'arrêt



Thermostatic valve
2 WAYS FREE

Valvola
 termostatica con 2
 vie indipendenti

Valve
 thermostatique par
 2 voies d'arrêt



Thermostatic valve
3 WAYS FREE

Valvola
 termostatica con 3
 vie indipendenti

Valve
 thermostatique par
 3 voies d'arrêt



Thermostatic valve
4 WAYS FREE

Valvola
 termostatica con 4
 vie indipendenti

Valve
 thermostatique par
 4 voies d'arrêt



Thermostatic valve
5 WAYS FREE

Valvola
 termostatica con 5
 vie indipendenti

Valve
 thermostatique par
 5 voies d'arrêt



Thermostatic valve
2 WAYS DIVERTER

Valvola
 termostatica con 2
 vie deviate

Valve
 thermostatique à 2
 voies déviées



Thermostatic valve
3 WAYS DIVERTER

Valvola
 termostatica con 3
 vie deviate

Valve
 thermostatique à 3
 voies déviées

POSSIBLE FUNCTIONS | POSSIBILI FUNZIONI | FONCTIONS POSSIBLES

Aqua

Thermostatic valve

**1
WAY
FREE**

RECESSED BODY PRICE
PREZZO CORPO INCASSO
PRIX PARTIE ENCASTRÉ

IUA100CCXN_1 8,6

PLATE AND HANDLES TRIMKIT
KIT PIASTRA E MANIGLIE
KIT PLAQUE ET POIGNÉE

EUA111CCNHJ 17,4

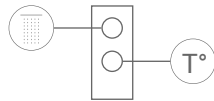

Thermostatic valve

**2
WAYS
FREE**

RECESSED BODY PRICE
PREZZO CORPO INCASSO
PRIX PARTIE ENCASTRÉ

IUA200CCXN_1 9,5

PLATE AND HANDLES TRIMKIT
KIT PIASTRA E MANIGLIE
KIT PLAQUE ET POIGNÉE

EUA222CCNMR2 26,8

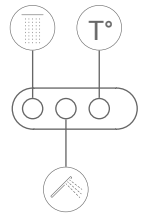

Thermostatic valve

**3
WAYS
FREE**

RECESSED BODY PRICE
PREZZO CORPO INCASSO
PRIX PARTIE ENCASTRÉ

IUA300CCXN_1 10,3

PLATE AND HANDLES TRIMKIT
KIT PIASTRA E MANIGLIE
KIT PLAQUE ET POIGNÉE

EUA312CCNKU 26,3

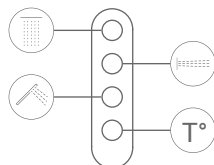

Thermostatic valve

**4
WAYS
FREE**

RECESSED BODY PRICE
PREZZO CORPO INCASSO
PRIX PARTIE ENCASTRÉ

IUA400CCXN_1 12,4

PLATE AND HANDLES TRIMKIT
KIT PIASTRA E MANIGLIE
KIT PLAQUE ET POIGNÉE

EUA421CCNID1 32,1

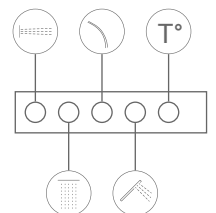

Thermostatic valve

5
WAYS
FREE

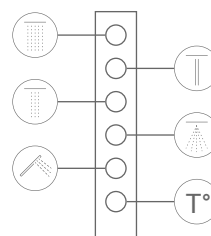

RECESSED BODY PRICE
PREZZO CORPO INCASSO
PRIX PARTIE ENCASTRÉ

IUA500CCXN_1 14,0

PLATE AND HANDLES TRIMKIT
KIT PIASTRA E MANIGLIE
KIT PLAQUE ET POIGNÉE

EUA511CCNHJ 37,4

Thermostatic valve

2
WAYS
DIVERTER

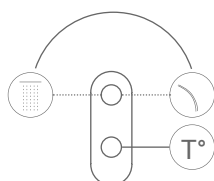

RECESSED BODY PRICE
PREZZO CORPO INCASSO
PRIX PARTIE ENCASTRÉ

IUA002CCXN_1 8,8

PLATE AND HANDLES TRIMKIT
KIT PIASTRA E MANIGLIE
KIT PLAQUE ET POIGNÉE

EUA612CCNKU 17,4

Thermostatic valve

3
WAYS
DIVERTER

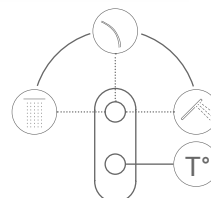

RECESSED BODY PRICE
PREZZO CORPO INCASSO
PRIX PARTIE ENCASTRÉ

IUA003CCXN_1 9,4

PLATE AND HANDLES TRIMKIT
KIT PIASTRA E MANIGLIE
KIT PLAQUE ET POIGNÉE

EUA712CCNKU 17,4

Aqua

Aesthetics.

Estetica.
Esthétique

The eclectic AQUA collection also offers twelve different types of handles and three different plates, which can be installed vertically or horizontally to satisfy all tastes and adapt to all environments.

La versatile collezione Aqua dispone inoltre di dodici diverse tipologie di maniglia e di tre diverse piastre, installabili in posizione verticale o orizzontale, per soddisfare tutti i gusti e adattarsi a tutti gli ambienti.
De plus, la collection universelle Aqua dispose de douze types de poignées et trois PLAQUEEs différentes, qui peuvent être installés en position verticale ou horizontale, pour satisfaire tous les goûts et s'adapter à tous les milieux.



Love Me



Belmondo



Bold



Hermes



Kusasi



Rubacuori



Wow



Hey Joe



Batlò



Marmo Black
Marquina



Marmo White
Carrara



Industria



Birkin



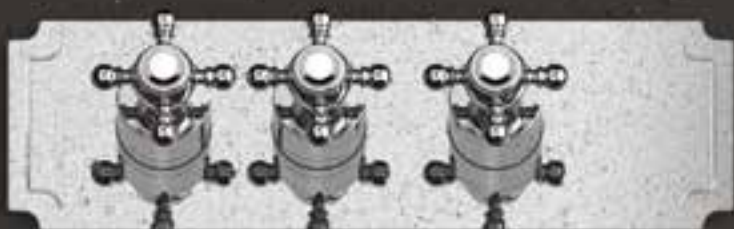

AQUA

Thermostatic 1 way

Termostatico 1 via
Thermostatique 1 voie

ARTICLE | ARTICOLO | ARTICLE

IUA100CCXN_1

Only the built-in 1\2" thermostatic unit of compact size, horizontal / vertical installation
Solo parte incasso termostatico 1/2 " ingombro ridotto, installazione orizzontale / verticale.
Seulement partie encastré du thermostatique 1/2" économie d'espace, installation horizontale / vertical.

CODE / COEFFICIENT | CODICE / COEFFICIENTE | CODE / COEFFICIENT

8,6

TECHNICAL DATA

Minimum dynamic pressure 0,5 bar
Maximum operational pressure 5 bar
Recommended operational pressure da 1 a 5 bar
Maximum hot water temperature 80°C

GENERAL FEATURES

Installation depth from 80 mm to 90 mm.
The intakes are fitted with G1/2" female G3/4" Male threaded connection, the outlets only G1/2"F (1, 2 or 3 way).
The temperature regulator lever is pre-set at 38°C.
Use of a pressure reducer is recommended if pressures in the system exceed 5 bar.

DATI TECNICI

Pressione dinamica minima 0,5 bar
Pressione di esercizio massima 5 bar
Pressione di utilizzo raccomandata da 1 a 5 bar
Temperatura massima acqua calda 80°C

CARATTERISTICHE GENERALI

Profondità di installazione da 80 mm a 90 mm.
Le entrate vengono fornite con filetto G1/2" femmina G3/4" maschio, le uscite solo G1/2"F (1, 2 o 3 vie).
La maniglia di regolazione temperatura, viene pre-settata a 38°C.
Si raccomanda l'utilizzo di un riduttore di pressione, se all'interno dell'impianto, si hanno pressioni superiori a 5 bar.

DONNÉES TECHNIQUES

Pression dynamique minimum 0,5 bar
Pression de service maximale de 5 bar
Pression d'utilisation conseillé de 1 à 5 bar
Température maximale de l'eau chaude 80 ° C

CARACTERISTIQUES GENERALES

Profondeur de montage de 80 mm à 90 mm.
Les entrées sont fournis avec filetage G1/2" femelle G3/4" mâle, les sorties G1/2"F (1,2,ou 3 voies).
La poignée de réglage de la température, est pré-réglée à 38 ° C Si à l'intérieur du système vous avez des pressions supérieures à 5 bars, il est recommandé l'utilisation d'un réducteur de pression..

Built-in part - Parte incasso - Corps encastré

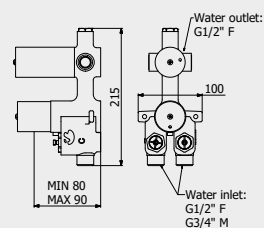

Plate and handles - Parte esterna - Plaque et poignée

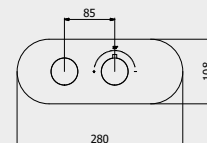
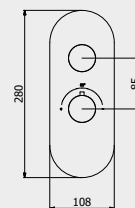

Plate and handles - Parte esterna - Plaque et poignée



PACKAGING

L: 240 mm D: 115 mm H: 160 mm 3,4 kg

ORIENTATION | ORIENTAZIONE | ORIENTATION

2 ways to Installation: horizontal or vertical
2 modalità di installazione: verticale o orizzontale
2 modalit  de installation: vertical ou horizontal .

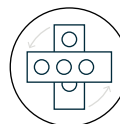

FOR ALL MODELS
PER TUTTI I MODELLI
POUR TOUS LES MODÈLES





A **Mixed water outlet**
Uscita acqua miscelata
Sortie eau mélangé



H **Hot water**
Acqua calda
Eau chaude



C **Cold water**
Acqua fredda
Eau froide

Aqua

PORTATE | WATER FLOW | DÉBIT D'EAU

0.2 BAR	0.5 BAR	1 BAR	2 BAR	3 BAR	4 BAR	5 BAR
10,7 l/m	18 l/m	26 l/m	37 l/m	45 l/m	51 l/m	56 l/m

Hey Joe!



RECESSED BODY
CORPO INCASSO
PARTIE ENCASTRÉ
IUA100CCXN_1 8,6

PACKAGING

L: 530 mm
D: 145 mm
H: 90 mm

4,16 kg



VERTICAL | VERTICALE | VERTICAL

PLATE AND HANDLES TRIMKIT
KIT PIASTRA E MANIGLIE
KIT PLAQUE ET POIGNÉE

CC	EUA112CCNHJ	17,3
SS	EUA112SSNHJ	21,6
BO	EUA112BONHJ	20,8
NP	EUA112NPNHJ	20,8
CF	EUA112CFNHJ	26,0
CS	EUA112CSNHJ	27,7
OO	EUA112OONHJ	26,0
II	EUA112IINHJ	26,0
IS	EUA112ISNHJ	27,7
RS	EUA112RSNHJ	26,0
SR	EUA112SRNHJ	27,7
OS	EUA112OSNHJ	27,7

HORIZONTAL | ORIZZONTALE | HORIZONTAL

PLATE AND HANDLES TRIMKIT
KIT PIASTRA E MANIGLIE
KIT PLAQUE ET POIGNÉE

CC	EUA122CCNHJ	17,3
SS	EUA122SSNHJ	21,6
BO	EUA122BONHJ	20,8
NP	EUA122NPNHJ	20,8
CF	EUA122CFNHJ	26,0
CS	EUA122CSNHJ	27,7
OO	EUA122OONHJ	26,0
II	EUA122IINHJ	26,0
IS	EUA122ISNHJ	27,7
RS	EUA122RSNHJ	26,0
SR	EUA122SRNHJ	27,7
OS	EUA122OSNHJ	27,7

Loveme



RECESSED BODY
CORPO INCASSO
PARTIE ENCASTRÉ
IUA100CCXN_1 8,6

PACKAGING

L: 530 mm
D: 145 mm
H: 90 mm

4,16 kg



VERTICAL | VERTICALE | VERTICAL

PLATE AND HANDLES TRIMKIT
KIT PIASTRA E MANIGLIE
KIT PLAQUE ET POIGNÉE

CC	EUA112CCNLM	17,3
SS	EUA112SSNLM	21,6
BO	EUA112BONLM	20,8
NP	EUA112NPNLM	20,8
CS	EUA112CSNLM	27,7
IS	EUA112ISNLM	27,7
SR	EUA112SRNLM	27,7
OS	EUA112OSNLM	27,7
ON	EUA112ONNLM	17,3

HORIZONTAL | ORIZZONTALE | HORIZONTAL

PLATE AND HANDLES TRIMKIT
KIT PIASTRA E MANIGLIE
KIT PLAQUE ET POIGNÉE

CC	EUA122CCNLM	17,3
SS	EUA122SSNLM	21,6
BO	EUA122BONLM	20,8
NP	EUA122NPNLM	20,8
CS	EUA122CSNLM	27,7
IS	EUA122ISNLM	27,7
SR	EUA122SRNLM	27,7
OS	EUA122OSNLM	27,7
ON	EUA122ONNLM	17,3

Belmondo



RECESSED BODY
CORPO INCASSO
PARTIE ENCASTRÉ
IUA100CCXN_1 8,6

PACKAGING

L: 530 mm
D: 145 mm
H: 90 mm

4,16 kg



VERTICAL | VERTICALE | VERTICAL

PLATE AND HANDLES TRIMKIT
KIT PIASTRA E MANIGLIE
KIT PLAQUE ET POIGNÉE

CC	EUA112CCNBT	17,3
OO	EUA112OONBT	26,0
II	EUA112IINBT	26,0
RS	EUA112RSNBT	26,0
PL	EUA112PLNBT	27,7

HORIZONTAL | ORIZZONTALE | HORIZONTAL

PLATE AND HANDLES TRIMKIT
KIT PIASTRA E MANIGLIE
KIT PLAQUE ET POIGNÉE

CC	EUA122CCNBT	17,3
OO	EUA122OONBT	26,0
II	EUA122IINBT	26,0
RS	EUA122RSNBT	26,0
PL	EUA122PLNBT	27,7

Batlò



RECESSED BODY
CORPO INCASSO
PARTIE ENCASTRÉ
IUA100CCXN_1 8,6

PACKAGING

L: 530 mm
D: 145 mm
H: 90 mm

4,16 kg



VERTICAL | VERTICALE | VERTICAL

PLATE AND HANDLES TRIMKIT
KIT PIASTRA E MANIGLIE
KIT PLAQUE ET POIGNÉE

CC	EUA112CCNBI	17,3
SS	EUA112SSNBI	21,6
BO	EUA112BONBI	20,8
NP	EUA112NPNBI	20,8
CF	EUA112CFNBI	26,0
CS	EUA112CSNBI	27,7
OO	EUA112OONBI	26,0
II	EUA112IINBI	26,0
IS	EUA112ISNBI	27,7
RS	EUA112RSNBI	26,0
SR	EUA112SRNBI	27,7
OS	EUA112OSNBI	27,7

HORIZONTAL | ORIZZONTALE | HORIZONTAL

PLATE AND HANDLES TRIMKIT
KIT PIASTRA E MANIGLIE
KIT PLAQUE ET POIGNÉE

CC	EUA122CCNBI	17,3
SS	EUA122SSNBI	21,6
BO	EUA122BONBI	20,8
NP	EUA122NPNBI	20,8
CF	EUA122CFNBI	26,0
CS	EUA122CSNBI	27,7
OO	EUA122OONBI	26,0
II	EUA122IINBI	26,0
IS	EUA122ISNBI	27,7
RS	EUA122RSNBI	26,0
SR	EUA122SRNBI	27,7
OS	EUA122OSNBI	27,7

Kusasi



RECESSED BODY
CORPO INCASSO
PARTIE ENCASTRÉ
IUA100CCXN_1 8,6

PACKAGING

L: 530 mm
D: 145 mm
H: 90 mm

4,16 kg



VERTICAL | VERTICALE | VERTICAL

PLATE AND HANDLES TRIMKIT
KIT PIASTRA E MANIGLIE
KIT PLAQUE ET POIGNÉE

CC	EUA112CCNKU	17,3
SS	EUA112SSNKU	21,6
NP	EUA112NPNKU	20,8

HORIZONTAL | ORIZZONTALE | HORIZONTAL

PLATE AND HANDLES TRIMKIT
KIT PIASTRA E MANIGLIE
KIT PLAQUE ET POIGNÉE

CC	EUA122CCNKU	17,3
SS	EUA122SSNKU	21,6
NP	EUA122NPNKU	20,8

Wow



RECESSED BODY
CORPO INCASSO
PARTIE ENCASTRÉ
IUA100CCXN_1 8,6

PACKAGING

L: 530 mm
D: 145 mm
H: 90 mm

4,16 kg

VERTICAL | VERTICALE | VERTICAL

PLATE AND HANDLES TRIMKIT
KIT PIASTRA E MANIGLIE
KIT PLAQUE ET POIGNÉE

CC	EUA112CCNWO	17,3
SS	EUA112SSNWO	21,6
BO	EUA112BONWO	20,8
NP	EUA112NPNWO	20,8
OO	EUA112OONWO	26,0

HORIZONTAL | ORIZZONTALE | HORIZONTAL

PLATE AND HANDLES TRIMKIT
KIT PIASTRA E MANIGLIE
KIT PLAQUE ET POIGNÉE

CC	EUA122CCNWO	17,3
SS	EUA122SSNWO	21,6
BO	EUA122BONWO	20,8
NP	EUA122NPNWO	20,8
OO	EUA122OONWO	26,0

Industria



RECESSED BODY
CORPO INCASSO
PARTIE ENCASTRÉ
IUA100CCXN_1 8,6

PACKAGING

L: 530 mm
D: 145 mm
H: 90 mm

4,16 kg

VERTICAL | VERTICALE | VERTICAL

PLATE AND HANDLES TRIMKIT
KIT PIASTRA E MANIGLIE
KIT PLAQUE ET POIGNÉE

CC	EUA112CCNID1	17,3
SS	EUA112SSNID1	21,6
NP	EUA112NPNID1	20,8
CF	EUA112CFNID1	26,0
CS	EUA112CSNID1	27,7
OO	EUA112OONID1	26,0
II	EUA112IINID1	26,0
IS	EUA112ISNID1	27,7
RS	EUA112RSNID1	26,0
SR	EUA112SRNID1	27,7
OS	EUA112OSNID1	27,7
ON	EUA112ONNID1	17,3

HORIZONTAL | ORIZZONTALE | HORIZONTAL

PLATE AND HANDLES TRIMKIT
KIT PIASTRA E MANIGLIE
KIT PLAQUE ET POIGNÉE

CC	EUA122CCNID1	17,3
SS	EUA122SSNID1	21,6
NP	EUA122NPNID1	20,8
CF	EUA122CFNID1	26,0
CS	EUA122CSNID1	27,7
OO	EUA122OONID1	26,0
II	EUA122IINID1	26,0
IS	EUA122ISNID1	27,7
RS	EUA122RSNID1	26,0
SR	EUA122SRNID1	27,7
OS	EUA122OSNID1	27,7
ON	EUA122ONNID1	17,3

Bold



RECESSED BODY
CORPO INCASSO
PARTIE ENCASTRÉ
IUA100CCXN_1 8,6

PACKAGING

L: 530 mm
D: 145 mm
H: 90 mm

4,16 kg

VERTICAL | VERTICALE | VERTICAL

PLATE AND HANDLES TRIMKIT
KIT PIASTRA E MANIGLIE
KIT PLAQUE ET POIGNÉE

CC	EUA112CCNB1	18,3
SS	EUA112SSNB1	22,9
NP	EUA112NPNB1	22,0
CF	EUA112CFNB1	27,5
CS	EUA112CSNB1	29,3
OO	EUA112OONB1	27,5
II	EUA112IINB1	27,5
IS	EUA112ISNB1	29,3
RS	EUA112RSNB1	27,5
SR	EUA112SRNB1	29,3
OS	EUA112OSNB1	29,3
ON	EUA112ONNB1	18,3

HORIZONTAL | ORIZZONTALE | HORIZONTAL

PLATE AND HANDLES TRIMKIT
KIT PIASTRA E MANIGLIE
KIT PLAQUE ET POIGNÉE

CC	EUA122CCNB1	18,3
SS	EUA122SSNB1	22,9
NP	EUA122NPNB1	22,0
CF	EUA122CFNB1	27,5
CS	EUA122CSNB1	29,3
OO	EUA122OONB1	27,5
II	EUA122IINB1	27,5
IS	EUA122ISNB1	29,3
RS	EUA122RSNB1	27,5
SR	EUA122SRNB1	29,3
OS	EUA122OSNB1	29,3
ON	EUA122ONNB1	18,3

Birkin



RECESSED BODY
CORPO INCASSO
PARTIE ENCASTRÉ
IUA100CCXN_1 8,6

PACKAGING

L: 530 mm
D: 145 mm
H: 90 mm

4,16 kg

VERTICAL | VERTICALE | VERTICAL

PLATE AND HANDLES TRIMKIT
KIT PIASTRA E MANIGLIE
KIT PLAQUE ET POIGNÉE

CC	EUA112CCNBR3	22,3
SS	EUA112SSNBR3	27,9
RS	EUA112RSNBR3	33,5
OS	EUA112OSNBR3	35,7
PL	EUA112PLNBR3	35,7

HORIZONTAL | ORIZZONTALE | HORIZONTAL

PLATE AND HANDLES TRIMKIT
KIT PIASTRA E MANIGLIE
KIT PLAQUE ET POIGNÉE

CC	EUA122CCNBR3	22,3
SS	EUA122SSNBR3	27,9
RS	EUA122RSNBR3	33,5
OS	EUA122OSNBR3	35,7
PL	EUA122PLNBR3	35,7

Marmo



RECESSED BODY
CORPO INCASSO
PARTIE ENCASTRÉ
IUA100CCXN_1 8,6

PACKAGING

L: 530 mm
D: 145 mm
H: 90 mm

4,24 kg

MARBLE

White Carrara

Black Marquina

VERTICAL | VERTICALE | VERTICAL

PLATE AND HANDLES TRIMKIT
KIT PIASTRA E MANIGLIE
KIT PLAQUE ET POIGNÉE

CC	EUA112CCNMR1	EUA112CCNMR2	20,7
SS	EUA112SSNMR1	EUA112SSNMR2	25,9
BO	EUA112BONMR1	EUA112BONMR2	24,9
NP	EUA112NPNMR1	EUA112NPNMR2	24,9
CF	EUA112CFNMR1	EUA112CFNMR2	31,1
CS	EUA112CSNMR1	EUA112CSNMR2	33,2
OO	EUA112OONMR1	EUA112OONMR2	31,1
II	EUA112IINMR1	EUA112IINMR2	31,1
IS	EUA112ISNMR1	EUA112ISNMR2	33,2
RS	EUA112RSNMR1	EUA112RSNMR2	31,1
SR	EUA112SRNMR1	EUA112SRNMR2	33,2
OS	EUA112OSNMR1	EUA112OSNMR2	33,2
ON	EUA112ONNMR1	EUA112PLNMR2	20,7
PL	EUA112PLNMR1	EUA112PLNMR2	33,2

HORIZONTAL | ORIZZONTALE | HORIZONTAL

PLATE AND HANDLES TRIMKIT
KIT PIASTRA E MANIGLIE
KIT PLAQUE ET POIGNÉE

CC	EUA122CCNMR1	EUA122CCNMR2	20,7
SS	EUA122SSNMR1	EUA122SSNMR2	25,9
BO	EUA122BONMR1	EUA122BONMR2	24,9
NP	EUA122NPNMR1	EUA122NPNMR2	24,9
CF	EUA122CFNMR1	EUA122CFNMR2	31,1
CS	EUA122CSNMR1	EUA122CSNMR2	33,2
OO	EUA122OONMR1	EUA122OONMR2	31,1
II	EUA122IINMR1	EUA122IINMR2	31,1
IS	EUA122ISNMR1	EUA122ISNMR2	33,2
RS	EUA122RSNMR1	EUA122RSNMR2	31,1
SR	EUA122SRNMR1	EUA122SRNMR2	33,2
OS	EUA122OSNMR1	EUA122OSNMR2	33,2
ON	EUA122ONNMR1	EUA122PLNMR2	20,7
PL	EUA122PLNMR1	EUA122PLNMR2	33,2

Aqua

Rubacuori



RECESSED BODY
CORPO INCASSO
PARTIE ENCASTRÉ
IUA100CCXN_1 8,6

PACKAGING

L: 530 mm
D: 145 mm
H: 90 mm

4,16 kg



VERTICAL | VERTICALE | VERTICAL

PLATE AND HANDLES TRIMKIT
KIT PIASTRA E MANIGLIE
KIT PLAQUE ET POIGNÉE

CC	EUA111CCNRU	17,3
SS	EUA111SSNRU	21,6
BO	EUA111BONRU	20,8
NP	EUA111NPNRU	20,8
CF	EUA111CFNRU	26,0
CS	EUA111CSNRU	27,7
OO	EUA111OONRU	26,0
II	EUA111IINRU	26,0
IS	EUA111ISNRU	27,7
RS	EUA111RSNRU	26,0
SR	EUA111SRNRU	27,7
OS	EUA111OSNRU	27,7

HORIZONTAL | ORIZZONTALE | HORIZONTAL

PLATE AND HANDLES TRIMKIT
KIT PIASTRA E MANIGLIE
KIT PLAQUE ET POIGNÉE

CC	EUA121CCNRU	17,3
SS	EUA121SSNRU	21,6
BO	EUA121BONRU	20,8
NP	EUA121NPNRU	20,8
CF	EUA121CFNRU	26,0
CS	EUA121CSNRU	27,7
OO	EUA121OONRU	26,0
II	EUA121IINRU	26,0
IS	EUA121ISNRU	27,7
RS	EUA121RSNRU	26,0
SR	EUA121SRNRU	27,7
OS	EUA121OSNRU	27,7

Hey joe!



RECESSED BODY
CORPO INCASSO
PARTIE ENCASTRÉ
IUA100CCXN_1 8,6

PACKAGING

L: 530 mm
D: 145 mm
H: 90 mm

4,16 kg



VERTICAL | VERTICALE | VERTICAL

PLATE AND HANDLES TRIMKIT
KIT PIASTRA E MANIGLIE
KIT PLAQUE ET POIGNÉE

CC	EUA111CCNRU	17,3
SS	EUA111SSNRU	21,6
BO	EUA111BONRU	20,8
NP	EUA111NPNRU	20,8
CF	EUA111CFNRU	26,0
CS	EUA111CSNRU	27,7
OO	EUA111OONRU	26,0
II	EUA111IINRU	26,0
IS	EUA111ISNRU	27,7
RS	EUA111RSNRU	26,0
SR	EUA111SRNRU	27,7
OS	EUA111OSNRU	27,7

HORIZONTAL | ORIZZONTALE | HORIZONTAL

PLATE AND HANDLES TRIMKIT
KIT PIASTRA E MANIGLIE
KIT PLAQUE ET POIGNÉE

CC	EUA121CCNRU	17,3
SS	EUA121SSNRU	21,6
BO	EUA121BONRU	20,8
NP	EUA121NPNRU	20,8
CF	EUA121CFNRU	26,0
CS	EUA121CSNRU	27,7
OO	EUA121OONRU	26,0
II	EUA121IINRU	26,0
IS	EUA121ISNRU	27,7
RS	EUA121RSNRU	26,0
SR	EUA121SRNRU	27,7
OS	EUA121OSNRU	27,7

Belmondo



RECESSED BODY
CORPO INCASSO
PARTIE ENCASTRÉ
IUA100CCXN_1 8,6

PACKAGING

L: 530 mm
D: 145 mm
H: 90 mm

4,16 kg



VERTICAL | VERTICALE | VERTICAL

PLATE AND HANDLES TRIMKIT
KIT PIASTRA E MANIGLIE
KIT PLAQUE ET POIGNÉE

CC	EUA111CCNBT	17,3
OO	EUA111OONBT	26,0
II	EUA111IINBT	26,0
RS	EUA111RSNBT	26,0
PL	EUA111PLNBT	27,7

HORIZONTAL | ORIZZONTALE | HORIZONTAL

PLATE AND HANDLES TRIMKIT
KIT PIASTRA E MANIGLIE
KIT PLAQUE ET POIGNÉE

CC	EUA121CCNBT	17,3
OO	EUA121OONBT	26,0
II	EUA121IINBT	26,0
RS	EUA121RSNBT	26,0
PL	EUA121PLNBT	27,7

Kusasi



RECESSED BODY
CORPO INCASSO
PARTIE ENCASTRÉ
IUA100CCXN_1 8,6

PACKAGING

L: 530 mm
D: 145 mm
H: 90 mm

4,16 kg



VERTICAL | VERTICALE | VERTICAL

PLATE AND HANDLES TRIMKIT
KIT PIASTRA E MANIGLIE
KIT PLAQUE ET POIGNÉE

CC	EUA111CCNKU	17,3
SS	EUA111SSNKU	21,6
NP	EUA111NPNKU	20,8

HORIZONTAL | ORIZZONTALE | HORIZONTAL

PLATE AND HANDLES TRIMKIT
KIT PIASTRA E MANIGLIE
KIT PLAQUE ET POIGNÉE

CC	EUA121CCNKU	17,3
SS	EUA121SSNKU	21,6
NP	EUA121NPNKU	20,8

Wow



RECESSED BODY
CORPO INCASSO
PARTIE ENCASTRÉ
IUA100CCXN_1 8,6

PACKAGING

L: 530 mm
D: 145 mm
H: 90 mm

4,16 kg



VERTICAL | VERTICALE | VERTICAL

PLATE AND HANDLES TRIMKIT
KIT PIASTRA E MANIGLIE
KIT PLAQUE ET POIGNÉE

CC	EUA111CCNWO	17,3
SS	EUA111SSNWO	21,6
BO	EUA111BONWO	20,8
NP	EUA111NPNWO	20,8
OO	EUA111OONWO	26,0

HORIZONTAL | ORIZZONTALE | HORIZONTAL

PLATE AND HANDLES TRIMKIT
KIT PIASTRA E MANIGLIE
KIT PLAQUE ET POIGNÉE

CC	EUA121CCNWO	17,3
SS	EUA121SSNWO	21,6
BO	EUA121BONWO	20,8
NP	EUA121NPNWO	20,8
OO	EUA121OONWO	26,0

Industria



RECESSED BODY
CORPO INCASSO
PARTIE ENCASTRÉ
IUA100CCXN_1 8,6

PACKAGING

L: 530 mm
D: 145 mm
H: 90 mm

4,16 kg

VERTICAL | VERTICALE | VERTICAL

PLATE AND HANDLES TRIMKIT
KIT PIASTRA E MANIGLIE
KIT PLAQUE ET POIGNÉE

CC	EUA111CCNID1	17,3
SS	EUA111SSNID1	21,6
NP	EUA111NPNID1	20,8
CF	EUA111CFNID1	26,0
CS	EUA111CSNID1	27,7
OO	EUA111OONID1	26,0
II	EUA111IINID1	26,0
IS	EUA111ISNID1	27,7
RS	EUA111RSNID1	26,0
SR	EUA111SRNID1	27,7
OS	EUA111OSNID1	27,7
ON	EUA111ONNID1	17,3

HORIZONTAL | ORIZZONTALE | HORIZONTAL

PLATE AND HANDLES TRIMKIT
KIT PIASTRA E MANIGLIE
KIT PLAQUE ET POIGNÉE

CC	EUA121CCNID1	17,3
SS	EUA121SSNID1	21,6
NP	EUA121NPNID1	20,8
CF	EUA121CFNID1	26,0
CS	EUA121CSNID1	27,7
OO	EUA121OONID1	26,0
II	EUA121IINID1	26,0
IS	EUA121ISNID1	27,7
RS	EUA121RSNID1	26,0
SR	EUA121SRNID1	27,7
OS	EUA121OSNID1	27,7
ON	EUA121ONNID1	17,3

Marmo



RECESSED BODY
CORPO INCASSO
PARTIE ENCASTRÉ
IUA100CCXN_1 8,6

PACKAGING

L: 530 mm
D: 145 mm
H: 90 mm

4,24 kg

MARBLE

White Carrara

Black Marquina

VERTICAL | VERTICALE | VERTICAL

PLATE AND HANDLES TRIMKIT
KIT PIASTRA E MANIGLIE
KIT PLAQUE ET POIGNÉE

CC	EUA111CCNMR1	EUA111CCNMR2	20,7
SS	EUA111SSNMR1	EUA111SSNMR2	25,9
BO	EUA111BONMR1	EUA111BONMR2	24,9
NP	EUA111NPNMR1	EUA111NPNMR2	24,9
CF	EUA111CFNMR1	EUA111CFNMR2	31,1
CS	EUA111CSNMR1	EUA111CSNMR2	33,2
OO	EUA111OONMR1	EUA111OONMR2	31,1
II	EUA111IINMR1	EUA111IINMR2	31,1
IS	EUA111ISNMR1	EUA111ISNMR2	33,2
RS	EUA111RSNMR1	EUA111RSNMR2	31,1
SR	EUA111SRNMR1	EUA111SRNMR2	33,2
OS	EUA111OSNMR1	EUA111OSNMR2	33,2
ON	EUA111ONNMR1	EUA111PLNMR2	20,7
PL	EUA111PLNMR1	EUA111PLNMR2	33,2

HORIZONTAL | ORIZZONTALE | HORIZONTAL

PLATE AND HANDLES TRIMKIT
KIT PIASTRA E MANIGLIE
KIT PLAQUE ET POIGNÉE

CC	EUA121CCNMR1	EUA121CCNMR2	20,7
SS	EUA121SSNMR1	EUA121SSNMR2	25,9
BO	EUA121BONMR1	EUA121BONMR2	24,9
NP	EUA121NPNMR1	EUA121NPNMR2	24,9
CF	EUA121CFNMR1	EUA121CFNMR2	31,1
CS	EUA121CSNMR1	EUA121CSNMR2	33,2
OO	EUA121OONMR1	EUA121OONMR2	31,1
II	EUA121IINMR1	EUA121IINMR2	31,1
IS	EUA121ISNMR1	EUA121ISNMR2	33,2
RS	EUA121RSNMR1	EUA121RSNMR2	31,1
SR	EUA121SRNMR1	EUA121SRNMR2	33,2
OS	EUA121OSNMR1	EUA121OSNMR2	33,2
ON	EUA121ONNMR1	EUA121PLNMR2	20,7
PL	EUA121PLNMR1	EUA121PLNMR2	33,2

Hermes



RECESSED BODY
CORPO INCASSO
PARTIE ENCASTRÉ
IUA100CCXN_1 8,6

PACKAGING

L: 530 mm
D: 145 mm
H: 90 mm

4,16 kg

VERTICAL | VERTICALE | VERTICAL

PLATE AND HANDLES TRIMKIT
KIT PIASTRA E MANIGLIE
KIT PLAQUE ET POIGNÉE

CC	EUA115CCNHR	17,4
SS	EUA115SSNHR	21,8
II	EUA115IINHR	26,1
RS	EUA115RSNHR	26,1
OS	EUA115OSNHR	27,9
RR	EUA115RRNHR	24,4
BB	EUA115BBNHR	24,4
PL	EUA115PLNHR	27,9

HORIZONTAL | ORIZZONTALE | HORIZONTAL

PLATE AND HANDLES TRIMKIT
KIT PIASTRA E MANIGLIE
KIT PLAQUE ET POIGNÉE

CC	EUA125CCNHR	17,4
SS	EUA125SSNHR	21,8
II	EUA115IINHR	26,1
RS	EUA125RSNHR	26,1
OS	EUA125OSNHR	27,9
RR	EUA125RRNHR	24,4
BB	EUA125BBNHR	24,4
PL	EUA125PLNHR	27,9

Birkin



RECESSED BODY
CORPO INCASSO
PARTIE ENCASTRÉ
IUA100CCXN_1 8,6

PACKAGING

L: 530 mm
D: 145 mm
H: 90 mm

4,16 kg

VERTICAL | VERTICALE | VERTICAL

PLATE AND HANDLES TRIMKIT
KIT PIASTRA E MANIGLIE
KIT PLAQUE ET POIGNÉE

CC	EUA115CCNBR3	22,3
SS	EUA115SSNBR3	27,9
RS	EUA115RSNBR3	33,5
OS	EUA115OSNBR3	35,7
PL	EUA115PLNBR3	35,7

HORIZONTAL | ORIZZONTALE | HORIZONTAL

PLATE AND HANDLES TRIMKIT
KIT PIASTRA E MANIGLIE
KIT PLAQUE ET POIGNÉE

CC	EUA125CCNBR3	22,3
SS	EUA125SSNBR3	27,9
RS	EUA125RSNBR3	33,5
OS	EUA125OSNBR3	35,7
PL	EUA125PLNBR3	35,7

Aqua

AQUA

Thermostatic 2 ways

Termostatico 2 vie
Thermostatique 2 voies

ARTICLE | ARTICOLO | ARTICLE

IUA200CCXN_1

Only the built-in 1½" thermostatic unit of compact size, horizontal / vertical installation
Solo parte incasso termostatico 1/2 " ingombro ridotto, installazione orizzontale / verticale.
Seulement partie encastré du thermostatique 1/2" économie d'espace, installation horizontale / vertical.

CODE / COEFFICIENT | CODICE / COEFFICIENTE | CODE / COEFFICIENT

9,5

TECHNICAL DATA

Minimum dynamic pressure 0,5 bar
Maximum operational pressure 5 bar
Recommended operational pressure da 1 a 5 bar
Maximum hot water temperature 80°C

GENERAL FEATURES

Installation depth from 80 mm to 90 mm.
The intakes are fitted with G1/2" female G3/4" Male threaded connection, the outlets only G1/2"F (1, 2 or 3 way).
The temperature regulator lever is pre-set at 38°C.
Use of a pressure reducer is recommended if pressures in the system exceed 5 bar.

DATI TECNICI

Pressione dinamica minima 0,5 bar
Pressione di esercizio massima 5 bar
Pressione di utilizzo raccomandata da 1 a 5 bar
Temperatura massima acqua calda 80°C

CARATTERISTICHE GENERALI

Profondità di installazione da 80 mm a 90 mm.
Le entrate vengono fornite con filetto G1/2" femmina G3/4" maschio, le uscite solo G1/2"F (1, 2 o 3 vie).
La maniglia di regolazione temperatura, viene pre-settata a 38°C.
Si raccomanda l'utilizzo di un riduttore di pressione, se all'interno dell'impianto, si hanno pressioni superiori a 5 bar.

DONNÉES TECHNIQUES

Pression dynamique minimum 0,5 bar
Pression de service maximale de 5 bar
Pression d'utilisation conseillé de 1 à 5 bar
Température maximale de l'eau chaude 80 ° C

CARACTERISTIQUES GENERALES

Profondeur de montage de 80 mm à 90 mm.
Les entrées sont fournis avec filetage G1/2" femelle G3/4" mâle, les sorties G1/2"F (1,2,ou 3 voies).
La poignée de réglage de la température, est pré-réglée à 38 ° C Si à l'intérieur du système vous avez des pressions supérieures à 5 bars, il est recommandé l'utilisation d'un réducteur de pression..

Built-in part - Parte incasso - Corps encastré

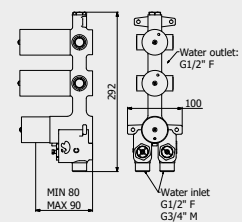

Plate and handles - Parte esterna - Plaque et poignée

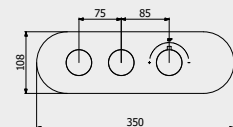
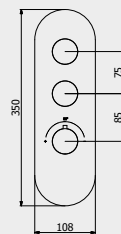

Plate and handles - Parte esterna - Plaque et poignée



PACKAGING

L: 240 mm D: 115 mm H: 160 mm 3,9 kg

ORIENTATION | ORIENTAZIONE | ORIENTATION

2 ways to installation: horizontal or vertical
2 modalità di installazione: verticale o orizzontale
2 modalit  de installation: vertical ou horizontal .

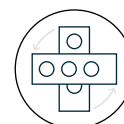

FOR ALL MODELS
PER TUTTI I MODELLI
POUR TOUS LES MODÈLES





A Mixed water outlet
Uscita acqua miscelata
Sortie eau mélangé



B Mixed water outlet
Uscita acqua miscelata
Sortie eau mélangé



H Hot water
Acqua calda
Eau chaude



C Cold water
Acqua fredda
Eau froide

Aqua

PORTATE | WATER FLOW | DÉBIT D'EAU

0.2 BAR	0.5 BAR	1 BAR	2 BAR	3 BAR	4 BAR	5 BAR
10,7 l/m	18 l/m	26 l/m	37 l/m	45 l/m	51 l/m	56 l/m

Hey Joe!



RECESSED BODY
CORPO INCASSO
PARTIE ENCASTRÉ
IUA200CCXN_1 9,5

PACKAGING

L: 530 mm
D: 145 mm
H: 90 mm

4,16 kg



VERTICAL | VERTICALE | VERTICAL

PLATE AND HANDLES TRIMKIT
KIT PIASTRA E MANIGLIE
KIT PLAQUE ET POIGNÉE

CC	EUA212CCNHJ	21,8
SS	EUA212SSNHJ	27,3
BO	EUA212BONHJ	26,2
NP	EUA212NPNHJ	26,2
CF	EUA212CFNHJ	32,7
CS	EUA212CSNHJ	34,9
OO	EUA212OONHJ	32,7
II	EUA212IINHJ	32,7
IS	EUA212ISNHJ	34,9
RS	EUA212RSNHJ	32,7
SR	EUA212SRNHJ	34,9
OS	EUA212OSNHJ	34,9

HORIZONTAL | ORIZZONTALE | HORIZONTAL

PLATE AND HANDLES TRIMKIT
KIT PIASTRA E MANIGLIE
KIT PLAQUE ET POIGNÉE

CC	EUA222CCNHJ	21,8
SS	EUA222SSNHJ	27,3
BO	EUA222BONHJ	26,2
NP	EUA222NPNHJ	26,2
CF	EUA222CFNHJ	32,7
CS	EUA222CSNHJ	34,9
OO	EUA222OONHJ	32,7
II	EUA222IINHJ	32,7
IS	EUA222ISNHJ	34,9
RS	EUA222RSNHJ	32,7
SR	EUA222SRNHJ	34,9
OS	EUA222OSNHJ	34,9

Loveme



RECESSED BODY
CORPO INCASSO
PARTIE ENCASTRÉ
IUA200CCXN_1 9,5

PACKAGING

L: 530 mm
D: 145 mm
H: 90 mm

4,16 kg



VERTICAL | VERTICALE | VERTICAL

PLATE AND HANDLES TRIMKIT
KIT PIASTRA E MANIGLIE
KIT PLAQUE ET POIGNÉE

CC	EUA212CCNLM	21,8
SS	EUA212SSNLM	27,3
BO	EUA212BONLM	26,2
NP	EUA212NPNLM	26,2
CS	EUA212CSNLM	34,9
IS	EUA212ISNLM	34,9
SR	EUA212SRNLM	34,9
OS	EUA212OSNLM	34,9
ON	EUA212ONNLM	21,8

HORIZONTAL | ORIZZONTALE | HORIZONTAL

PLATE AND HANDLES TRIMKIT
KIT PIASTRA E MANIGLIE
KIT PLAQUE ET POIGNÉE

CC	EUA222CCNLM	21,8
SS	EUA222SSNLM	27,3
BO	EUA222BONLM	26,2
NP	EUA222NPNLM	26,2
CS	EUA222CSNLM	34,9
IS	EUA222ISNLM	34,9
SR	EUA222SRNLM	34,9
OS	EUA222OSNLM	34,9
ON	EUA222ONNLM	21,8

Belmondo



RECESSED BODY
CORPO INCASSO
PARTIE ENCASTRÉ
IUA200CCXN_1 9,5

PACKAGING

L: 530 mm
D: 145 mm
H: 90 mm

4,16 kg



VERTICAL | VERTICALE | VERTICAL

PLATE AND HANDLES TRIMKIT
KIT PIASTRA E MANIGLIE
KIT PLAQUE ET POIGNÉE

CC	EUA212CCNBT	21,8
OO	EUA212OONBT	32,7
II	EUA212IINBT	32,7
RS	EUA212RSNBT	32,7
PL	EUA212PLNBT	34,9

HORIZONTAL | ORIZZONTALE | HORIZONTAL

PLATE AND HANDLES TRIMKIT
KIT PIASTRA E MANIGLIE
KIT PLAQUE ET POIGNÉE

CC	EUA222CCNBT	21,8
OO	EUA222OONBT	32,7
II	EUA222IINBT	32,7
RS	EUA222RSNBT	32,7
PL	EUA222PLNBT	34,9

Batlò



RECESSED BODY
CORPO INCASSO
PARTIE ENCASTRÉ
IUA200CCXN_1 9,5

PACKAGING

L: 530 mm
D: 145 mm
H: 90 mm

4,16 kg



VERTICAL | VERTICALE | VERTICAL

PLATE AND HANDLES TRIMKIT
KIT PIASTRA E MANIGLIE
KIT PLAQUE ET POIGNÉE

CC	EUA212CCNBI	21,8
SS	EUA212SSNBI	27,3
BO	EUA212BONBI	26,2
NP	EUA212NPNBI	26,2
CF	EUA212CFNBI	32,7
CS	EUA212CSNBI	34,9
OO	EUA212OONBI	32,7
II	EUA212IINBI	32,7
IS	EUA212ISNBI	34,9
RS	EUA212RSNBI	32,7
SR	EUA212SRNBI	34,9
OS	EUA212OSNBI	34,9

HORIZONTAL | ORIZZONTALE | HORIZONTAL

PLATE AND HANDLES TRIMKIT
KIT PIASTRA E MANIGLIE
KIT PLAQUE ET POIGNÉE

CC	EUA222CCNBI	21,8
SS	EUA222SSNBI	27,3
BO	EUA222BONBI	26,2
NP	EUA222NPNBI	26,2
CF	EUA222CFNBI	32,7
CS	EUA222CSNBI	34,9
OO	EUA222OONBI	32,7
II	EUA222IINBI	32,7
IS	EUA222ISNBI	34,9
RS	EUA222RSNBI	32,7
SR	EUA222SRNBI	34,9
OS	EUA222OSNBI	34,9

Kusasi



RECESSED BODY
CORPO INCASSO
PARTIE ENCASTRÉ
IUA200CCXN_1 9,5

PACKAGING

L: 530 mm
D: 145 mm
H: 90 mm

4,16 kg



VERTICAL | VERTICALE | VERTICAL

PLATE AND HANDLES TRIMKIT
KIT PIASTRA E MANIGLIE
KIT PLAQUE ET POIGNÉE

CC	EUA212CCNKU	21,8
SS	EUA212SSNKU	27,3
NP	EUA212NPNKU	26,2

HORIZONTAL | ORIZZONTALE | HORIZONTAL

PLATE AND HANDLES TRIMKIT
KIT PIASTRA E MANIGLIE
KIT PLAQUE ET POIGNÉE

CC	EUA122CCNKU	21,8
SS	EUA122SSNKU	27,3
NP	EUA122NPNKU	26,2

Wow

RECESSED BODY
CORPO INCASSO
PARTIE ENCASTRÉ

IUA200CCXN_1 9,5



PACKAGING

L: 530 mm
D: 145 mm
H: 90 mm

4,16 kg

VERTICAL | VERTICALE | VERTICAL

PLATE AND HANDLES TRIMKIT
KIT PIASTRA E MANIGLIE
KIT PLAQUE ET POIGNÉE

CC	EUA212CCNWO	21,8
SS	EUA212SSNWO	27,3
BO	EUA212BONWO	26,2
NP	EUA212NPNWO	26,2
OO	EUA212OONWO	32,7

HORIZONTAL | ORIZZONTALE | HORIZONTAL

PLATE AND HANDLES TRIMKIT
KIT PIASTRA E MANIGLIE
KIT PLAQUE ET POIGNÉE

CC	EUA222CCNWO	21,8
SS	EUA222SSNWO	27,3
BO	EUA222BONWO	26,2
NP	EUA222NPNWO	26,2
OO	EUA222OONWO	32,7

Industria

RECESSED BODY
CORPO INCASSO
PARTIE ENCASTRÉ

IUA200CCXN_1 9,5



PACKAGING

L: 530 mm
D: 145 mm
H: 90 mm

4,16 kg

VERTICAL | VERTICALE | VERTICAL

PLATE AND HANDLES TRIMKIT
KIT PIASTRA E MANIGLIE
KIT PLAQUE ET POIGNÉE

CC	EUA212CCNID1	21,8
SS	EUA212SSNID1	27,3
NP	EUA212NPNID1	26,2
CF	EUA212CFNID1	32,7
CS	EUA212CSNID1	34,9
OO	EUA212OONID1	32,7
II	EUA212IINID1	32,7
IS	EUA212ISNID1	34,9
RS	EUA212RSNID1	32,7
SR	EUA212SRNID1	34,9
OS	EUA212OSNID1	34,9
ON	EUA212ONNID1	21,8

HORIZONTAL | ORIZZONTALE | HORIZONTAL

PLATE AND HANDLES TRIMKIT
KIT PIASTRA E MANIGLIE
KIT PLAQUE ET POIGNÉE

CC	EUA222CCNID1	21,8
SS	EUA222SSNID1	27,3
NP	EUA222NPNID1	26,2
CF	EUA222CFNID1	32,7
CS	EUA222CSNID1	34,9
OO	EUA222OONID1	32,7
II	EUA222IINID1	32,7
IS	EUA222ISNID1	34,9
RS	EUA222RSNID1	32,7
SR	EUA222SRNID1	34,9
OS	EUA222OSNID1	34,9
ON	EUA222ONNID1	21,8

Bold

RECESSED BODY
CORPO INCASSO
PARTIE ENCASTRÉ

IUA200CCXN_1 9,5



PACKAGING

L: 530 mm
D: 145 mm
H: 90 mm

4,16 kg

VERTICAL | VERTICALE | VERTICAL

PLATE AND HANDLES TRIMKIT
KIT PIASTRA E MANIGLIE
KIT PLAQUE ET POIGNÉE

CC	EUA212CCNB1	23,1
SS	EUA212SSNB1	28,9
NP	EUA212NPNB1	27,8
CF	EUA212CFNB1	34,7
CS	EUA212CSNB1	37,0
OO	EUA212OONB1	34,7
II	EUA212IINB1	34,7
IS	EUA212ISNB1	37,0
RS	EUA212RSNB1	34,7
SR	EUA212SRNB1	37,0
OS	EUA212OSNB1	37,0
ON	EUA212ONNB1	23,1

HORIZONTAL | ORIZZONTALE | HORIZONTAL

PLATE AND HANDLES TRIMKIT
KIT PIASTRA E MANIGLIE
KIT PLAQUE ET POIGNÉE

CC	EUA222CCNB1	23,1
SS	EUA222SSNB1	28,9
NP	EUA222NPNB1	27,8
CF	EUA222CFNB1	34,7
CS	EUA222CSNB1	37,0
OO	EUA222OONB1	34,7
II	EUA222IINB1	34,7
IS	EUA222ISNB1	37,0
RS	EUA222RSNB1	34,7
SR	EUA222SRNB1	37,0
OS	EUA222OSNB1	37,0
ON	EUA222ONNB1	23,1

Birkin

RECESSED BODY
CORPO INCASSO
PARTIE ENCASTRÉ

IUA200CCXN_1 9,5



PACKAGING

L: 530 mm
D: 145 mm
H: 90 mm

4,16 kg

VERTICAL | VERTICALE | VERTICAL

PLATE AND HANDLES TRIMKIT
KIT PIASTRA E MANIGLIE
KIT PLAQUE ET POIGNÉE

CC	EUA212CCNBR3	29,2
SS	EUA212SSNBR3	36,5
RS	EUA212RSNBR3	43,7
OS	EUA212OSNBR3	46,7
PL	EUA212PLNBR3	46,7

HORIZONTAL | ORIZZONTALE | HORIZONTAL

PLATE AND HANDLES TRIMKIT
KIT PIASTRA E MANIGLIE
KIT PLAQUE ET POIGNÉE

CC	EUA222CCNBR3	29,2
SS	EUA222SSNBR3	36,5
RS	EUA222RSNBR3	43,7
OS	EUA222OSNBR3	46,7
PL	EUA222PLNBR3	46,7

Marmo

RECESSED BODY
CORPO INCASSO
PARTIE ENCASTRÉ

IUA200CCXN_1 9,5



PACKAGING

L: 530 mm
D: 145 mm
H: 90 mm

4,28 kg

MARBLE

White Carrara

Black Marquina

VERTICAL | VERTICALE | VERTICAL

PLATE AND HANDLES TRIMKIT
KIT PIASTRA E MANIGLIE
KIT PLAQUE ET POIGNÉE

CC	EUA212CCNMR1	EUA212CCNMR2	26,8
SS	EUA212SSNMR1	EUA212SSNMR2	33,5
BO	EUA212BONMR1	EUA212BONMR2	32,2
NP	EUA212NPNMR1	EUA212NPNMR2	32,2
CF	EUA212CFNMR1	EUA212CFNMR2	40,2
CS	EUA212CSNMR1	EUA212CSNMR2	42,9
OO	EUA212OONMR1	EUA212OONMR2	40,2
II	EUA212IINMR1	EUA212IINMR2	40,2
IS	EUA212ISNMR1	EUA212ISNMR2	42,9
RS	EUA212RSNMR1	EUA212RSNMR2	40,2
SR	EUA212SRNMR1	EUA212SRNMR2	42,9
OS	EUA212OSNMR1	EUA212OSNMR2	42,9
ON	EUA212ONNMR1	EUA212PLNMR2	26,8
PL	EUA212PLNMR1	EUA212PLNMR2	42,9

HORIZONTAL | ORIZZONTALE | HORIZONTAL

PLATE AND HANDLES TRIMKIT
KIT PIASTRA E MANIGLIE
KIT PLAQUE ET POIGNÉE

CC	EUA222CCNMR1	EUA222CCNMR2	26,8
SS	EUA222SSNMR1	EUA222SSNMR2	33,5
BO	EUA222BONMR1	EUA222BONMR2	32,2
NP	EUA222NPNMR1	EUA222NPNMR2	32,2
CF	EUA222CFNMR1	EUA222CFNMR2	40,2
CS	EUA222CSNMR1	EUA222CSNMR2	42,9
OO	EUA222OONMR1	EUA222OONMR2	40,2
II	EUA222IINMR1	EUA222IINMR2	40,2
IS	EUA222ISNMR1	EUA222ISNMR2	42,9
RS	EUA222RSNMR1	EUA222RSNMR2	40,2
SR	EUA222SRNMR1	EUA222SRNMR2	42,9
OS	EUA222OSNMR1	EUA222OSNMR2	42,9
ON	EUA222ONNMR1	EUA222PLNMR2	26,8
PL	EUA222PLNMR1	EUA222PLNMR2	42,9

Aqua

Rubacuori



RECESSED BODY
CORPO INCASSO
PARTIE ENCASTRÉ
IUA200CCXN_1 9,5

PACKAGING

L: 530 mm
D: 145 mm
H: 90 mm

4,16 kg



VERTICAL | VERTICALE | VERTICAL

PLATE AND HANDLES TRIMKIT
KIT PIASTRÀ E MANIGLIE
KIT PLAQUE ET POIGNÉE

CC	EUA211CCNRU	21,8
SS	EUA211SSNRU	27,3
BO	EUA211BONRU	26,2
NP	EUA211NPNRU	26,2
CF	EUA211CFNRU	32,7
CS	EUA211CSNRU	34,9
OO	EUA211OONRU	32,7
II	EUA211IINRU	32,7
IS	EUA211ISNRU	34,9
RS	EUA211RSNRU	32,7
SR	EUA211SRNRU	34,9
OS	EUA211OSNRU	34,9

HORIZONTAL | ORIZZONTALE | HORIZONTAL

PLATE AND HANDLES TRIMKIT
KIT PIASTRÀ E MANIGLIE
KIT PLAQUE ET POIGNÉE

CC	EUA221CCNRU	21,8
SS	EUA221SSNRU	27,3
BO	EUA221BONRU	26,2
NP	EUA221NPNRU	26,2
CF	EUA221CFNRU	32,7
CS	EUA221CSNRU	34,9
OO	EUA221OONRU	32,7
II	EUA221IINRU	32,7
IS	EUA221ISNRU	34,9
RS	EUA221RSNRU	32,7
SR	EUA221SRNRU	34,9
OS	EUA221OSNRU	34,9

Hey joe!



RECESSED BODY
CORPO INCASSO
PARTIE ENCASTRÉ
IUA200CCXN_1 9,5

PACKAGING

L: 530 mm
D: 145 mm
H: 90 mm

4,16 kg



VERTICAL | VERTICALE | VERTICAL

PLATE AND HANDLES TRIMKIT
KIT PIASTRÀ E MANIGLIE
KIT PLAQUE ET POIGNÉE

CC	EUA211CCNHJ	21,8
SS	EUA211SSNHJ	27,3
BO	EUA211BONHJ	26,2
NP	EUA211NPNHJ	26,2
CF	EUA211CFNHJ	32,7
CS	EUA211CSNHJ	34,9
OO	EUA211OONHJ	32,7
II	EUA211IINHJ	32,7
IS	EUA211ISNHJ	34,9
RS	EUA211RSNHJ	32,7
SR	EUA211SRNHJ	34,9
OS	EUA211OSNHJ	34,9

HORIZONTAL | ORIZZONTALE | HORIZONTAL

PLATE AND HANDLES TRIMKIT
KIT PIASTRÀ E MANIGLIE
KIT PLAQUE ET POIGNÉE

CC	EUA221CCNHJ	21,8
SS	EUA221SSNHJ	27,3
BO	EUA221BONHJ	26,2
NP	EUA221NPNHJ	26,2
CF	EUA221CFNHJ	32,7
CS	EUA221CSNHJ	34,9
OO	EUA221OONHJ	32,7
II	EUA221IINHJ	32,7
IS	EUA221ISNHJ	34,9
RS	EUA221RSNHJ	32,7
SR	EUA221SRNHJ	34,9
OS	EUA221OSNHJ	34,9

Belmondo



RECESSED BODY
CORPO INCASSO
PARTIE ENCASTRÉ
IUA200CCXN_1 9,5

PACKAGING

L: 530 mm
D: 145 mm
H: 90 mm

4,16 kg



VERTICAL | VERTICALE | VERTICAL

PLATE AND HANDLES TRIMKIT
KIT PIASTRÀ E MANIGLIE
KIT PLAQUE ET POIGNÉE

CC	EUA211CCNBT	21,8
OO	EUA211OONBT	32,7
II	EUA211IINBT	32,7
RS	EUA211RSNBT	32,7
PL	EUA211PLNBT	34,9

HORIZONTAL | ORIZZONTALE | HORIZONTAL

PLATE AND HANDLES TRIMKIT
KIT PIASTRÀ E MANIGLIE
KIT PLAQUE ET POIGNÉE

CC	EUA221CCNBT	21,8
OO	EUA221OONBT	32,7
II	EUA221IINBT	32,7
RS	EUA221RSNBT	32,7
PL	EUA221PLNBT	34,9

Kusasi



RECESSED BODY
CORPO INCASSO
PARTIE ENCASTRÉ
IUA200CCXN_1 9,5

PACKAGING

L: 530 mm
D: 145 mm
H: 90 mm

4,16 kg



VERTICAL | VERTICALE | VERTICAL

PLATE AND HANDLES TRIMKIT
KIT PIASTRÀ E MANIGLIE
KIT PLAQUE ET POIGNÉE

CC	EUA211CCNKU	21,8
SS	EUA211SSNKU	27,3
NP	EUA211NPNKU	26,2

HORIZONTAL | ORIZZONTALE | HORIZONTAL

PLATE AND HANDLES TRIMKIT
KIT PIASTRÀ E MANIGLIE
KIT PLAQUE ET POIGNÉE

CC	EUA221CCNKU	21,8
SS	EUA221SSNKU	27,3
NP	EUA221NPNKU	26,2

Wow



RECESSED BODY
CORPO INCASSO
PARTIE ENCASTRÉ
IUA200CCXN_1 9,5

PACKAGING

L: 530 mm
D: 145 mm
H: 90 mm

4,16 kg



VERTICAL | VERTICALE | VERTICAL

PLATE AND HANDLES TRIMKIT
KIT PIASTRÀ E MANIGLIE
KIT PLAQUE ET POIGNÉE

CC	EUA211CCNWO	21,8
SS	EUA211SSNWO	27,3
BO	EUA211BONWO	26,2
NP	EUA211NPNWO	26,2
OO	EUA211OONWO	32,7

HORIZONTAL | ORIZZONTALE | HORIZONTAL

PLATE AND HANDLES TRIMKIT
KIT PIASTRÀ E MANIGLIE
KIT PLAQUE ET POIGNÉE

CC	EUA221CCNWO	21,8
SS	EUA221SSNWO	27,3
BO	EUA221BONWO	26,2
NP	EUA221NPNWO	26,2
OO	EUA221OONWO	32,7



Industria

RECESSED BODY
CORPO INCASSO
PARTIE ENCASTRÉ

IUA200CCXN_1 9,5

PACKAGING

L: 530 mm
D: 145 mm
H: 90 mm

4,16 kg

VERTICAL | VERTICALE | VERTICAL

PLATE AND HANDLES TRIMKIT
KIT PIASTRA E MANIGLIE
KIT PLAQUE ET POIGNÉE

CC	EUA211CCNID1	21,8
SS	EUA211SSNID1	27,3
NP	EUA211NPNID1	26,2
CF	EUA211CFNID1	32,7
CS	EUA211CSNID1	34,9
OO	EUA211OONID1	32,7
II	EUA211IINID1	32,7
IS	EUA211ISNID1	34,9
RS	EUA211RSNID1	32,7
SR	EUA211SRNID1	34,9
OS	EUA211OSNID1	34,9
ON	EUA211ONNID1	21,8

HORIZONTAL | ORIZZONTALE | HORIZONTAL

PLATE AND HANDLES TRIMKIT
KIT PIASTRA E MANIGLIE
KIT PLAQUE ET POIGNÉE

CC	EUA221CCNID1	21,8
SS	EUA221SSNID1	27,3
NP	EUA221NPNID1	26,2
CF	EUA221CFNID1	32,7
CS	EUA221CSNID1	34,9
OO	EUA221OONID1	32,7
II	EUA221IINID1	32,7
IS	EUA221ISNID1	34,9
RS	EUA221RSNID1	32,7
SR	EUA221SRNID1	34,9
OS	EUA221OSNID1	34,9
ON	EUA221ONNID1	21,8

Marmo

RECESSED BODY
CORPO INCASSO
PARTIE ENCASTRÉ

IUA200CCXN_1 9,5

L: 530 mm
D: 145 mm
H: 90 mm

4,28 kg

MARBLE

White Carrara

Black Marquina

VERTICAL | VERTICALE | VERTICAL

PLATE AND HANDLES TRIMKIT
KIT PIASTRA E MANIGLIE
KIT PLAQUE ET POIGNÉE

CC	EUA211CCNMR1	EUA211CCNMR2	26,8
SS	EUA211SSNMR1	EUA211SSNMR2	33,5
BO	EUA211BONMR1	EUA211BONMR2	32,2
NP	EUA211NPNMR1	EUA211NPNMR2	32,2
CF	EUA211CFNMR1	EUA211CFNMR2	40,2
CS	EUA211CSNMR1	EUA211CSNMR2	42,9
OO	EUA211OONMR1	EUA211OONMR2	40,2
II	EUA211IINMR1	EUA211IINMR2	40,2
IS	EUA211ISNMR1	EUA211ISNMR2	42,9
RS	EUA211RSNMR1	EUA211RSNMR2	40,2
SR	EUA211SRNMR1	EUA211SRNMR2	42,9
OS	EUA211OSNMR1	EUA211OSNMR2	42,9
ON	EUA211ONNMR1	EUA211PLNMR2	26,8
PL	EUA211PLNMR1	EUA211PLNMR2	42,9

HORIZONTAL | ORIZZONTALE | HORIZONTAL

PLATE AND HANDLES TRIMKIT
KIT PIASTRA E MANIGLIE
KIT PLAQUE ET POIGNÉE

CC	EUA221CCNMR1	EUA221CCNMR2	26,8
SS	EUA221SSNMR1	EUA221SSNMR2	33,5
BO	EUA221BONMR1	EUA221BONMR2	32,2
NP	EUA221NPNMR1	EUA221NPNMR2	32,2
CF	EUA221CFNMR1	EUA221CFNMR2	40,2
CS	EUA221CSNMR1	EUA221CSNMR2	42,9
OO	EUA221OONMR1	EUA221OONMR2	40,2
II	EUA221IINMR1	EUA221IINMR2	40,2
IS	EUA221ISNMR1	EUA221ISNMR2	42,9
RS	EUA221RSNMR1	EUA221RSNMR2	40,2
SR	EUA221SRNMR1	EUA221SRNMR2	42,9
OS	EUA221OSNMR1	EUA221OSNMR2	42,9
ON	EUA221ONNMR1	EUA221PLNMR2	26,8
PL	EUA221PLNMR1	EUA221PLNMR2	42,9

Hermes

RECESSED BODY
CORPO INCASSO
PARTIE ENCASTRÉ

IUA200CCXN_1 9,5

PACKAGING

L: 530 mm
D: 145 mm
H: 90 mm

4,16 kg

VERTICAL | VERTICALE | VERTICAL

PLATE AND HANDLES TRIMKIT
KIT PIASTRA E MANIGLIE
KIT PLAQUE ET POIGNÉE

CC	EUA215CCNHR	21,8
SS	EUA215SSNHR	27,3
II	EUA215IINHR	32,7
RS	EUA215RSNHR	32,7
OS	EUA215OSNHR	34,9
RR	EUA215RRNHR	30,5
BB	EUA215BBNHR	30,5
PL	EUA215PLNHR	34,9

HORIZONTAL | ORIZZONTALE | HORIZONTAL

PLATE AND HANDLES TRIMKIT
KIT PIASTRA E MANIGLIE
KIT PLAQUE ET POIGNÉE

CC	EUA225CCNHR	21,8
SS	EUA225SSNHR	27,3
II	EUA225IINHR	32,7
RS	EUA225RSNHR	32,7
OS	EUA225OSNHR	34,9
RR	EUA225RRNHR	30,5
BB	EUA225BBNHR	30,5
PL	EUA225PLNHR	34,9

Birkin

RECESSED BODY
CORPO INCASSO
PARTIE ENCASTRÉ

IUA200CCXN_1 9,5

PACKAGING

L: 530 mm
D: 145 mm
H: 90 mm

4,16 kg

VERTICAL | VERTICALE | VERTICAL

PLATE AND HANDLES TRIMKIT
KIT PIASTRA E MANIGLIE
KIT PLAQUE ET POIGNÉE

CC	EUA215CCNBR3	29,2
SS	EUA215SSNBR3	36,5
RS	EUA215RSNBR3	43,7
OS	EUA215OSNBR3	46,7
PL	EUA215PLNBR3	46,7

HORIZONTAL | ORIZZONTALE | HORIZONTAL

PLATE AND HANDLES TRIMKIT
KIT PIASTRA E MANIGLIE
KIT PLAQUE ET POIGNÉE

CC	EUA225CCNBR3	29,2
SS	EUA225SSNBR3	36,5
RS	EUA225RSNBR3	43,7
OS	EUA225OSNBR3	46,7
PL	EUA225PLNBR3	46,7

Aqua

AQUA

Thermostatic 3 ways

Termostatico 3 vie
Thermostatique 3 voies

ARTICLE | ARTICOLO | ARTICLE

IUA300CCXN_1

Only the built-in 1½" thermostatic unit of compact size, horizontal / vertical installation
Solo parte incasso termostatico 1/2 " ingombro ridotto, installazione orizzontale / verticale.
Seulement partie encastré du thermostatique 1/2" économie d'espace, installation horizontale / vertical.

CODE / COEFFICIENT | CODICE / COEFFICIENTE | CODE / COEFFICIENT

10,3

TECHNICAL DATA

Minimum dynamic pressure 0,5 bar
Maximum operational pressure 5 bar
Recommended operational pressure da 1 a 5 bar
Maximum hot water temperature 80°C

GENERAL FEATURES

Installation depth from 80 mm to 90 mm.
The intakes are fitted with G1/2" female G3/4" Male threaded connection, the outlets only G1/2"F (1, 2 or 3 way).
The temperature regulator lever is pre-set at 38°C.
Use of a pressure reducer is recommended if pressures in the system exceed 5 bar.

DATI TECNICI

Pressione dinamica minima 0,5 bar
Pressione di esercizio massima 5 bar
Pressione di utilizzo raccomandata da 1 a 5 bar
Temperatura massima acqua calda 80°C

CARATTERISTICHE GENERALI

Profondità di installazione da 80 mm a 90 mm.
Le entrate vengono fornite con filetto G1/2" femmina G3/4" maschio, le uscite solo G1/2"F (1, 2 o 3 vie).
La maniglia di regolazione temperatura, viene pre-settata a 38°C.
Si raccomanda l'utilizzo di un riduttore di pressione, se all'interno dell'impianto, si hanno pressioni superiori a 5 bar.

DONNÉES TECHNIQUES

Pression dynamique minimum 0,5 bar
Pression de service maximale de 5 bar
Pression d'utilisation conseillé de 1 à 5 bar
Température maximale de l'eau chaude 80 ° C

CARACTERISTIQUES GENERALES

Profondeur de montage de 80 mm à 90 mm.
Les entrées sont fournis avec filetage G1/2" femelle G3/4" mâle, les sorties G1/2"F (1,2,ou 3 voies).
La poignée de réglage de la température, est pré-réglée à 38 ° C Si à l'intérieur du système vous avez des pressions supérieures à 5 bars, il est recommandé l'utilisation d'un réducteur de pression..

Built-in part - Parte incasso - Corps encastré

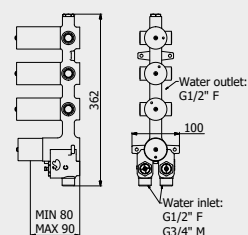

Plate and handles - Parte esterna - Plaque et poignée

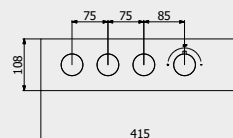
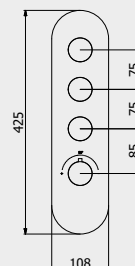

Plate and handles - Parte esterna - Plaque et poignée



PACKAGING

L: 310 mm D: 190 mm H: 165 mm 4,8 kg

ORIENTATION | ORIENTAZIONE | ORIENTATION

2 ways to installation: horizontal or vertical
2 modalità di installazione: verticale o orizzontale
2 modalitè de installation: vertical ou horizontal .

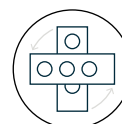

FOR ALL MODELS
PER TUTTI I MODELLI
POUR TOUS LES MODÈLES





A Mixed water outlet
Uscita acqua miscelata
Sortie eau mélangé



B Mixed water outlet
Uscita acqua miscelata
Sortie eau mélangé



C Mixed water outlet
Uscita acqua miscelata
Sortie eau mélangé



H Hot water
Acqua calda
Eau chaude



C Cold water
Acqua fredda
Eau froide

Aqua

PORTATE | WATER FLOW | DÉBIT D'EAU

0.2 BAR	0.5 BAR	1 BAR	2 BAR	3 BAR	4 BAR	5 BAR
10,7 l/m	18 l/m	26 l/m	37 l/m	45 l/m	51 l/m	56 l/m

Hey Joe!



RECESSED BODY
CORPO INCASSO
PARTIE ENCASTRÉ
IUA300CCXN_1 10,3

PACKAGING

L: 530 mm
D: 145 mm
H: 90 mm

4,56 kg



VERTICAL | VERTICALE | VERTICAL

PLATE AND HANDLES TRIMKIT
KIT PIASTRA E MANIGLIE
KIT PLAQUE ET POIGNÉE

CC	EUA312CCNHJ	25,9
SS	EUA312SSNHJ	32,4
BO	EUA312BONHJ	31,1
NP	EUA312NPNHJ	31,1
CF	EUA312CFNHJ	38,9
CS	EUA312CSNHJ	41,5
OO	EUA312OONHJ	38,9
II	EUA312IINHJ	38,9
IS	EUA312ISNHJ	41,5
RS	EUA312RSNHJ	38,9
SR	EUA312SRNHJ	41,5
OS	EUA312OSNHJ	41,5

HORIZONTAL | ORIZZONTALE | HORIZONTAL

PLATE AND HANDLES TRIMKIT
KIT PIASTRA E MANIGLIE
KIT PLAQUE ET POIGNÉE

CC	EUA322CCNHJ	25,9
SS	EUA322SSNHJ	32,4
BO	EUA322BONHJ	31,1
NP	EUA322NPNHJ	31,1
CF	EUA322CFNHJ	38,9
CS	EUA322CSNHJ	41,5
OO	EUA322OONHJ	38,9
II	EUA322IINHJ	38,9
IS	EUA322ISNHJ	41,5
RS	EUA322RSNHJ	38,9
SR	EUA322SRNHJ	41,5
OS	EUA322OSNHJ	41,5

Loveme



RECESSED BODY
CORPO INCASSO
PARTIE ENCASTRÉ
IUA300CCXN_1 10,3

PACKAGING

L: 530 mm
D: 145 mm
H: 90 mm

4,56 kg



VERTICAL | VERTICALE | VERTICAL

PLATE AND HANDLES TRIMKIT
KIT PIASTRA E MANIGLIE
KIT PLAQUE ET POIGNÉE

CC	EUA312CCNLM	25,9
SS	EUA312SSNLM	32,4
BO	EUA312BONLM	31,1
NP	EUA312NPNLM	31,1
CS	EUA312CSNLM	41,5
IS	EUA312ISNLM	41,5
SR	EUA312SRNLM	41,5
OS	EUA312OSNLM	41,5
ON	EUA312ONNLM	25,9

HORIZONTAL | ORIZZONTALE | HORIZONTAL

PLATE AND HANDLES TRIMKIT
KIT PIASTRA E MANIGLIE
KIT PLAQUE ET POIGNÉE

CC	EUA322CCNLM	25,9
SS	EUA322SSNLM	32,4
BO	EUA322BONLM	31,1
NP	EUA322NPNLM	31,1
CS	EUA322CSNLM	41,5
IS	EUA322ISNLM	41,5
SR	EUA322SRNLM	41,5
OS	EUA322OSNLM	41,5
ON	EUA322ONNLM	25,9

Belmondo



RECESSED BODY
CORPO INCASSO
PARTIE ENCASTRÉ
IUA300CCXN_1 10,3

PACKAGING

L: 530 mm
D: 145 mm
H: 90 mm

4,56 kg



VERTICAL | VERTICALE | VERTICAL

PLATE AND HANDLES TRIMKIT
KIT PIASTRA E MANIGLIE
KIT PLAQUE ET POIGNÉE

CC	EUA312CCNBT	25,9
OO	EUA312OONBT	38,9
II	EUA312IINBT	38,9
RS	EUA312RSNBT	38,9
PL	EUA312PLNBT	41,5

HORIZONTAL | ORIZZONTALE | HORIZONTAL

PLATE AND HANDLES TRIMKIT
KIT PIASTRA E MANIGLIE
KIT PLAQUE ET POIGNÉE

CC	EUA322CCNBT	25,9
OO	EUA322OONBT	38,9
II	EUA322IINBT	38,9
RS	EUA322RSNBT	38,9
PL	EUA322PLNBT	41,5

Batlò



RECESSED BODY
CORPO INCASSO
PARTIE ENCASTRÉ
IUA300CCXN_1 10,3

PACKAGING

L: 530 mm
D: 145 mm
H: 90 mm

4,56 kg



VERTICAL | VERTICALE | VERTICAL

PLATE AND HANDLES TRIMKIT
KIT PIASTRA E MANIGLIE
KIT PLAQUE ET POIGNÉE

CC	EUA312CCNBI	25,9
SS	EUA312SSNBI	32,4
BO	EUA312BONBI	31,1
NP	EUA312NPNBI	31,1
CF	EUA312CFNBI	38,9
CS	EUA312CSNBI	41,5
OO	EUA312OONBI	38,9
II	EUA312IINBI	38,9
IS	EUA312ISNBI	41,5
RS	EUA312RSNBI	38,9
SR	EUA312SRNBI	41,5
OS	EUA312OSNBI	41,5

HORIZONTAL | ORIZZONTALE | HORIZONTAL

PLATE AND HANDLES TRIMKIT
KIT PIASTRA E MANIGLIE
KIT PLAQUE ET POIGNÉE

CC	EUA322CCNBI	25,9
SS	EUA322SSNBI	32,4
BO	EUA322BONBI	31,1
NP	EUA322NPNBI	31,1
CF	EUA322CFNBI	38,9
CS	EUA322CSNBI	41,5
OO	EUA322OONBI	38,9
II	EUA322IINBI	38,9
IS	EUA322ISNBI	41,5
RS	EUA322RSNBI	38,9
SR	EUA322SRNBI	41,5
OS	EUA322OSNBI	41,5

Kusasi



RECESSED BODY
CORPO INCASSO
PARTIE ENCASTRÉ
IUA300CCXN_1 10,3

PACKAGING

L: 530 mm
D: 145 mm
H: 90 mm

4,56 kg



VERTICAL | VERTICALE | VERTICAL

PLATE AND HANDLES TRIMKIT
KIT PIASTRA E MANIGLIE
KIT PLAQUE ET POIGNÉE

CC	EUA312CCNKU	25,9
SS	EUA312SSNKU	32,4
NP	EUA312NPNKU	31,1

HORIZONTAL | ORIZZONTALE | HORIZONTAL

PLATE AND HANDLES TRIMKIT
KIT PIASTRA E MANIGLIE
KIT PLAQUE ET POIGNÉE

CC	EUA322CCNKU	25,9
SS	EUA322SSNKU	32,4
NP	EUA322NPNKU	31,1

Wow



RECESSED BODY
CORPO INCASSO
PARTIE ENCASTRÉ

IUA300CCXN_1 10,3

PACKAGING

L: 530 mm
D: 145 mm
H: 90 mm

4,56 kg

VERTICAL | VERTICALE | VERTICAL

PLATE AND HANDLES TRIMKIT
KIT PIASTRA E MANIGLIE
KIT PLAQUE ET POIGNÉE

CC	EUA312CCNWO	25,9
SS	EUA312SSNWO	32,4
BO	EUA312BONWO	31,1
NP	EUA312NPNWO	31,1
OO	EUA312OONWO	38,9

HORIZONTAL | ORIZZONTALE | HORIZONTAL

PLATE AND HANDLES TRIMKIT
KIT PIASTRA E MANIGLIE
KIT PLAQUE ET POIGNÉE

CC	EUA222CCNWO	25,9
SS	EUA222SSNWO	32,4
BO	EUA222BONWO	31,1
NP	EUA222NPNWO	31,1
OO	EUA222OONWO	38,9

Industria



RECESSED BODY
CORPO INCASSO
PARTIE ENCASTRÉ

IUA300CCXN_1 10,3

PACKAGING

L: 530 mm
D: 145 mm
H: 90 mm

4,56 kg

VERTICAL | VERTICALE | VERTICAL

PLATE AND HANDLES TRIMKIT
KIT PIASTRA E MANIGLIE
KIT PLAQUE ET POIGNÉE

CC	EUA312CCNID1	25,9
SS	EUA312SSNID1	32,4
NP	EUA312NPNID1	31,1
CF	EUA312CFNID1	38,9
CS	EUA312CSNID1	41,5
OO	EUA312OONID1	38,9
II	EUA312IINID1	38,9
IS	EUA312ISNID1	41,5
RS	EUA312RSNID1	38,9
SR	EUA312SRNID1	41,5
OS	EUA312OSNID1	41,5
ON	EUA312ONNID1	25,9

HORIZONTAL | ORIZZONTALE | HORIZONTAL

PLATE AND HANDLES TRIMKIT
KIT PIASTRA E MANIGLIE
KIT PLAQUE ET POIGNÉE

CC	EUA322CCNID1	25,9
SS	EUA322SSNID1	32,4
NP	EUA322NPNID1	31,1
CF	EUA322CFNID1	38,9
CS	EUA322CSNID1	41,5
OO	EUA322OONID1	38,9
II	EUA322IINID1	38,9
IS	EUA322ISNID1	41,5
RS	EUA322RSNID1	38,9
SR	EUA322SRNID1	41,5
OS	EUA322OSNID1	41,5
ON	EUA322ONNID1	25,9

Bold



RECESSED BODY
CORPO INCASSO
PARTIE ENCASTRÉ

IUA300CCXN_1 10,3

PACKAGING

L: 530 mm
D: 145 mm
H: 90 mm

4,56 kg

VERTICAL | VERTICALE | VERTICAL

PLATE AND HANDLES TRIMKIT
KIT PIASTRA E MANIGLIE
KIT PLAQUE ET POIGNÉE

CC	EUA312CCNB1	28,0
SS	EUA312SSNB1	34,9
NP	EUA312NPNB1	33,5
CF	EUA312CFNB1	41,9
CS	EUA312CSNB1	44,7
OO	EUA312OONB1	41,9
II	EUA312IINB1	41,9
IS	EUA312ISNB1	44,7
RS	EUA312RSNB1	41,9
SR	EUA312SRNB1	44,7
OS	EUA312OSNB1	44,7
ON	EUA312ONNB1	28,0

HORIZONTAL | ORIZZONTALE | HORIZONTAL

PLATE AND HANDLES TRIMKIT
KIT PIASTRA E MANIGLIE
KIT PLAQUE ET POIGNÉE

CC	EUA322CCNB1	28,0
SS	EUA322SSNB1	34,9
NP	EUA322NPNB1	33,5
CF	EUA322CFNB1	41,9
CS	EUA322CSNB1	44,7
OO	EUA322OONB1	41,9
II	EUA322IINB1	41,9
IS	EUA322ISNB1	44,7
RS	EUA322RSNB1	41,9
SR	EUA322SRNB1	44,7
OS	EUA322OSNB1	44,7
ON	EUA322ONNB1	28,0

Birkin



RECESSED BODY
CORPO INCASSO
PARTIE ENCASTRÉ

IUA300CCXN_1 10,3

PACKAGING

L: 530 mm
D: 145 mm
H: 90 mm

4,56 kg

VERTICAL | VERTICALE | VERTICAL

PLATE AND HANDLES TRIMKIT
KIT PIASTRA E MANIGLIE
KIT PLAQUE ET POIGNÉE

CC	EUA312CCNBR3	36,0
SS	EUA312SSNBR3	45,0
RS	EUA312RSNBR3	54,0
OS	EUA312OSNBR3	57,6
PL	EUA312PLNBR3	57,6

HORIZONTAL | ORIZZONTALE | HORIZONTAL

PLATE AND HANDLES TRIMKIT
KIT PIASTRA E MANIGLIE
KIT PLAQUE ET POIGNÉE

CC	EUA322CCNBR3	36,0
SS	EUA322SSNBR3	45,0
RS	EUA322RSNBR3	54,0
OS	EUA322OSNBR3	57,6
PL	EUA322PLNBR3	57,6

Marmo



RECESSED BODY
CORPO INCASSO
PARTIE ENCASTRÉ

IUA300CCXN_1 10,3

PACKAGING

L: 530 mm
D: 145 mm
H: 90 mm

4,72 kg

MARBLE

White Carrara

Black Marquina

VERTICAL | VERTICALE | VERTICAL

PLATE AND HANDLES TRIMKIT
KIT PIASTRA E MANIGLIE
KIT PLAQUE ET POIGNÉE

CC	EUA312CCNMR1	EUA312CCNMR2	32,8
SS	EUA312SSNMR1	EUA312SSNMR2	41,0
BO	EUA312BONMR1	EUA312BONMR2	39,4
NP	EUA312NPNMR1	EUA312NPNMR2	39,4
CF	EUA312CFNMR1	EUA312CFNMR2	49,3
CS	EUA312CSNMR1	EUA312CSNMR2	52,5
OO	EUA312OONMR1	EUA312OONMR2	49,3
II	EUA312IINMR1	EUA312IINMR2	49,3
IS	EUA312ISNMR1	EUA312ISNMR2	52,5
RS	EUA312RSNMR1	EUA312RSNMR2	49,3
SR	EUA312SRNMR1	EUA312SRNMR2	52,5
OS	EUA312OSNMR1	EUA312OSNMR2	52,5
ON	EUA312ONNMR1	EUA312PLNMR2	32,8
PL	EUA312PLNMR1	EUA312PLNMR2	52,5

HORIZONTAL | ORIZZONTALE | HORIZONTAL

PLATE AND HANDLES TRIMKIT
KIT PIASTRA E MANIGLIE
KIT PLAQUE ET POIGNÉE

CC	EUA322CCNMR1	EUA322CCNMR2	32,8
SS	EUA322SSNMR1	EUA322SSNMR2	41,0
BO	EUA322BONMR1	EUA322BONMR2	39,4
NP	EUA322NPNMR1	EUA322NPNMR2	39,4
CF	EUA322CFNMR1	EUA322CFNMR2	49,3
CS	EUA322CSNMR1	EUA322CSNMR2	52,5
OO	EUA322OONMR1	EUA322OONMR2	49,3
II	EUA322IINMR1	EUA322IINMR2	49,3
IS	EUA322ISNMR1	EUA322ISNMR2	52,5
RS	EUA322RSNMR1	EUA322RSNMR2	49,3
SR	EUA322SRNMR1	EUA322SRNMR2	52,5
OS	EUA322OSNMR1	EUA322OSNMR2	52,5
ON	EUA322ONNMR1	EUA322PLNMR2	32,8
PL	EUA322PLNMR1	EUA322PLNMR2	52,5

Aqua

Rubacuori



RECESSED BODY
CORPO INCASSO
PARTIE ENCASTRÉ
IUA300CCXN_1 10,3

PACKAGING

L: 530 mm
D: 145 mm
H: 90 mm

4,56 kg



VERTICAL | VERTICALE | VERTICAL

PLATE AND HANDLES TRIMKIT
KIT PIASTRA E MANIGLIE
KIT PLAQUE ET POIGNÉE

	CC	EUA311CCNRU	25,9
	SS	EUA311SSNRU	32,4
	BO	EUA311BONRU	31,1
	NP	EUA311NPNRU	31,1
	CF	EUA311CFNRU	38,9
	CS	EUA311CSNRU	41,5
	OO	EUA311OONRU	38,9
	II	EUA311IINRU	38,9
	IS	EUA311ISNRU	41,5
	RS	EUA311RSNRU	38,9
	SR	EUA311SRNRU	41,5
	OS	EUA311OSNRU	41,5



HORIZONTAL | ORIZZONTALE | HORIZONTAL

PLATE AND HANDLES TRIMKIT
KIT PIASTRA E MANIGLIE
KIT PLAQUE ET POIGNÉE

	CC	EUA321CCNRU	25,9
	SS	EUA321SSNRU	32,4
	BO	EUA321BONRU	31,1
	NP	EUA321NPNRU	31,1
	CF	EUA321CFNRU	38,9
	CS	EUA321CSNRU	41,5
	OO	EUA321OONRU	38,9
	II	EUA321IINRU	38,9
	IS	EUA321ISNRU	41,5
	RS	EUA321RSNRU	38,9
	SR	EUA321SRNRU	41,5
	OS	EUA321OSNRU	41,5



Hey joe!



RECESSED BODY
CORPO INCASSO
PARTIE ENCASTRÉ
IUA300CCXN_1 10,3

PACKAGING

L: 530 mm
D: 145 mm
H: 90 mm

4,56 kg



VERTICAL | VERTICALE | VERTICAL

PLATE AND HANDLES TRIMKIT
KIT PIASTRA E MANIGLIE
KIT PLAQUE ET POIGNÉE

	CC	EUA311CCNHJ	25,9
	SS	EUA311SSNHJ	32,4
	BO	EUA311BONHJ	31,1
	NP	EUA311NPNHJ	31,1
	CF	EUA311CFNHJ	38,9
	CS	EUA311CSNHJ	41,5
	OO	EUA311OONHJ	38,9
	II	EUA311IINHJ	38,9
	IS	EUA311ISNHJ	41,5
	RS	EUA311RSNHJ	38,9
	SR	EUA311SRNHJ	41,5
	OS	EUA311OSNHJ	41,5



HORIZONTAL | ORIZZONTALE | HORIZONTAL

PLATE AND HANDLES TRIMKIT
KIT PIASTRA E MANIGLIE
KIT PLAQUE ET POIGNÉE

	CC	EUA321CCNHJ	25,9
	SS	EUA321SSNHJ	32,4
	BO	EUA321BONHJ	31,1
	NP	EUA321NPNHJ	31,1
	CF	EUA321CFNHJ	38,9
	CS	EUA321CSNHJ	41,5
	OO	EUA321OONHJ	38,9
	II	EUA321IINHJ	38,9
	IS	EUA321ISNHJ	41,5
	RS	EUA321RSNHJ	38,9
	SR	EUA321SRNHJ	41,5
	OS	EUA321OSNHJ	41,5



Belmondo



RECESSED BODY
CORPO INCASSO
PARTIE ENCASTRÉ
IUA300CCXN_1 10,3

PACKAGING

L: 530 mm
D: 145 mm
H: 90 mm

4,56 kg



VERTICAL | VERTICALE | VERTICAL

PLATE AND HANDLES TRIMKIT
KIT PIASTRA E MANIGLIE
KIT PLAQUE ET POIGNÉE

	CC	EUA311CCNBT	25,9
	OO	EUA311OONBT	38,9
	II	EUA311IINBT	38,9
	RS	EUA311RSNBT	38,9
	PL	EUA311PLNBT	41,5



HORIZONTAL | ORIZZONTALE | HORIZONTAL

PLATE AND HANDLES TRIMKIT
KIT PIASTRA E MANIGLIE
KIT PLAQUE ET POIGNÉE

	CC	EUA321CCNBT	25,9
	OO	EUA321OONBT	38,9
	II	EUA321IINBT	38,9
	RS	EUA321RSNBT	38,9
	PL	EUA321PLNBT	41,5



Kusasi



RECESSED BODY
CORPO INCASSO
PARTIE ENCASTRÉ
IUA300CCXN_1 10,3

PACKAGING

L: 530 mm
D: 145 mm
H: 90 mm

4,56 kg



VERTICAL | VERTICALE | VERTICAL

PLATE AND HANDLES TRIMKIT
KIT PIASTRA E MANIGLIE
KIT PLAQUE ET POIGNÉE

	CC	EUA311CCNKU	25,9
	SS	EUA311SSNKU	32,4
	NP	EUA311NPNKU	31,1



HORIZONTAL | ORIZZONTALE | HORIZONTAL

PLATE AND HANDLES TRIMKIT
KIT PIASTRA E MANIGLIE
KIT PLAQUE ET POIGNÉE

	CC	EUA321CCNKU	25,9
	SS	EUA321SSNKU	32,4
	NP	EUA321NPNKU	31,1



Wow



RECESSED BODY
CORPO INCASSO
PARTIE ENCASTRÉ
IUA300CCXN_1 10,3

PACKAGING

L: 530 mm
D: 145 mm
H: 90 mm

4,56 kg



VERTICAL | VERTICALE | VERTICAL

PLATE AND HANDLES TRIMKIT
KIT PIASTRA E MANIGLIE
KIT PLAQUE ET POIGNÉE

	CC	EUA311CCNWO	25,9
	SS	EUA311SSNWO	32,4
	BO	EUA311BONWO	31,1
	NP	EUA311NPNWO	31,1
	OO	EUA311OONWO	38,9



HORIZONTAL | ORIZZONTALE | HORIZONTAL

PLATE AND HANDLES TRIMKIT
KIT PIASTRA E MANIGLIE
KIT PLAQUE ET POIGNÉE

	CC	EUA321CCNWO	25,9
	SS	EUA321SSNWO	32,4
	BO	EUA321BONWO	31,1
	NP	EUA321NPNWO	31,1
	OO	EUA321OONWO	38,9



Industria

RECESSED BODY
CORPO INCASSO
PARTIE ENCASTRÉ

IUA300CCXN_1 10,3

PACKAGING

L: 530 mm
D: 145 mm
H: 90 mm

4,56 kg

VERTICAL | VERTICALE | VERTICAL

PLATE AND HANDLES TRIMKIT
KIT PIASTRA E MANIGLIE
KIT PLAQUE ET POIGNÉE

CC	EUA311CCNID1	25,9
SS	EUA311SSNID1	32,4
NP	EUA311NPNID1	31,1
CF	EUA311CFNID1	38,9
CS	EUA311CSNID1	41,5
OO	EUA311OONID1	38,9
II	EUA311IINID1	38,9
IS	EUA311ISNID1	41,5
RS	EUA311RSNID1	38,9
SR	EUA311SRNID1	41,5
OS	EUA311OSNID1	41,5
ON	EUA311ONNID1	25,9

HORIZONTAL | ORIZZONTALE | HORIZONTAL

PLATE AND HANDLES TRIMKIT
KIT PIASTRA E MANIGLIE
KIT PLAQUE ET POIGNÉE

CC	EUA321CCNID1	25,9
SS	EUA321SSNID1	32,4
NP	EUA321NPNID1	31,1
CF	EUA321CFNID1	38,9
CS	EUA321CSNID1	41,5
OO	EUA321OONID1	38,9
II	EUA321IINID1	38,9
IS	EUA321ISNID1	41,5
RS	EUA321RSNID1	38,9
SR	EUA321SRNID1	41,5
OS	EUA321OSNID1	41,5
ON	EUA321ONNID1	25,9

Marmo

RECESSED BODY
CORPO INCASSO
PARTIE ENCASTRÉ

IUA300CCXN_1 10,3

PACKAGING

L: 530 mm
D: 145 mm
H: 90 mm

4,72 kg

MARBLE

White Carrara

Black Marquina

VERTICAL | VERTICALE | VERTICAL

PLATE AND HANDLES TRIMKIT
KIT PIASTRA E MANIGLIE
KIT PLAQUE ET POIGNÉE

CC	EUA311CCNMR1	EUA311CCNMR2	32,8
SS	EUA311SSNMR1	EUA311SSNMR2	41,0
BO	EUA311BONMR1	EUA311BONMR2	39,4
NP	EUA311NPNMR1	EUA311NPNMR2	39,4
CF	EUA311CFNMR1	EUA311CFNMR2	49,3
CS	EUA311CSNMR1	EUA311CSNMR2	52,5
OO	EUA311OONMR1	EUA311OONMR2	49,3
II	EUA311IINMR1	EUA311IINMR2	49,3
IS	EUA311ISNMR1	EUA311ISNMR2	52,5
RS	EUA311RSNMR1	EUA311RSNMR2	49,3
SR	EUA311SRNMR1	EUA311SRNMR2	52,5
OS	EUA311OSNMR1	EUA311OSNMR2	52,5
ON	EUA311ONNMR1	EUA311PLNMR2	32,8
PL	EUA311PLNMR1	EUA311PLNMR2	52,5

HORIZONTAL | ORIZZONTALE | HORIZONTAL

PLATE AND HANDLES TRIMKIT
KIT PIASTRA E MANIGLIE
KIT PLAQUE ET POIGNÉE

CC	EUA321CCNMR1	EUA321CCNMR2	32,8
SS	EUA321SSNMR1	EUA321SSNMR2	41,0
BO	EUA321BONMR1	EUA321BONMR2	39,4
NP	EUA321NPNMR1	EUA321NPNMR2	39,4
CF	EUA321CFNMR1	EUA321CFNMR2	49,3
CS	EUA321CSNMR1	EUA321CSNMR2	52,5
OO	EUA321OONMR1	EUA321OONMR2	49,3
II	EUA321IINMR1	EUA321IINMR2	49,3
IS	EUA321ISNMR1	EUA321ISNMR2	52,5
RS	EUA321RSNMR1	EUA321RSNMR2	49,3
SR	EUA321SRNMR1	EUA321SRNMR2	52,5
OS	EUA321OSNMR1	EUA321OSNMR2	52,5
ON	EUA321ONNMR1	EUA321PLNMR2	32,8
PL	EUA321PLNMR1	EUA321PLNMR2	52,5

Hermes

RECESSED BODY
CORPO INCASSO
PARTIE ENCASTRÉ

IUA300CCXN_1 10,3

PACKAGING

L: 530 mm
D: 145 mm
H: 90 mm

4,56 kg

VERTICAL | VERTICALE | VERTICAL

PLATE AND HANDLES TRIMKIT
KIT PIASTRA E MANIGLIE
KIT PLAQUE ET POIGNÉE

CC	EUA315CCNHR	26,3
SS	EUA315SSNHR	32,8
II	EUA315IINHR	39,4
RS	EUA315RSNHR	39,4
OS	EUA315OSNHR	42,0
RR	EUA315RRNHR	36,8
BB	EUA315BBNHR	36,8
PL	EUA315PLNHR	42,0

HORIZONTAL | ORIZZONTALE | HORIZONTAL

PLATE AND HANDLES TRIMKIT
KIT PIASTRA E MANIGLIE
KIT PLAQUE ET POIGNÉE

CC	EUA325CCNHR	26,3
SS	EUA325SSNHR	32,8
II	EUA325IINHR	39,4
RS	EUA325RSNHR	39,4
OS	EUA325OSNHR	42,0
RR	EUA325RRNHR	36,8
BB	EUA325BBNHR	36,8
PL	EUA325PLNHR	42,0

Birkin

RECESSED BODY
CORPO INCASSO
PARTIE ENCASTRÉ

IUA300CCXN_1 10,3

PACKAGING

L: 530 mm
D: 145 mm
H: 90 mm

4,56 kg

VERTICAL | VERTICALE | VERTICAL

PLATE AND HANDLES TRIMKIT
KIT PIASTRA E MANIGLIE
KIT PLAQUE ET POIGNÉE

CC	EUA315CCNBR3	36,0
SS	EUA315SSNBR3	45,0
RS	EUA315RSNBR3	54,0
OS	EUA315OSNBR3	57,6
PL	EUA315PLNBR3	57,6

HORIZONTAL | ORIZZONTALE | HORIZONTAL

PLATE AND HANDLES TRIMKIT
KIT PIASTRA E MANIGLIE
KIT PLAQUE ET POIGNÉE

CC	EUA325CCNBR3	36,0
SS	EUA325SSNBR3	45,0
RS	EUA325RSNBR3	54,0
OS	EUA325OSNBR3	57,6
PL	EUA325PLNBR3	57,6

Aqua

AQUA

Thermostatic 4 ways

Termostatico 4 vie
Thermostatique 4 voies

ARTICLE | ARTICOLO | ARTICLE

IUA400CCXN_1

Only the built-in 1½" thermostatic unit of compact size, horizontal / vertical installation
Solo parte incasso termostatico 1/2 " ingombro ridotto, installazione orizzontale / verticale.
Seulement partie encastré du thermostatique 1/2" économie d'espace, installation horizontale / vertical.

CODE / COEFFICIENT | CODICE / COEFFICIENTE | CODE / COEFFICIENT

12,4

TECHNICAL DATA

Minimum dynamic pressure 0,5 bar
Maximum operational pressure 5 bar
Recommended operational pressure da 1 a 5 bar
Maximum hot water temperature 80°C

GENERAL FEATURES

Installation depth from 80 mm to 90 mm.
The intakes are fitted with G1/2" female G3/4" Male female threaded connection, the outlets only G1/2"F (1, 2 or 3 way).
The temperature regulator lever is pre-set at 38°C.
Use of a pressure reducer is recommended if pressures in the system exceed 5 bar.

DATI TECNICI

Pressione dinamica minima 0,5 bar
Pressione di esercizio massima 5 bar
Pressione di utilizzo raccomandata da 1 a 5 bar
Temperatura massima acqua calda 80°C

CARATTERISTICHE GENERALI

Profondità di installazione da 80 mm a 90 mm.
Le entrate vengono fornite con filetto G1/2" femmina G3/4" maschio, le uscite solo G1/2"F (1, 2 o 3 vie).
La maniglia di regolazione temperatura, viene preasettata a 38°C.
Si raccomanda l'utilizzo di un riduttore di pressione, se all'interno dell'impianto, si hanno pressioni superiori a 5 bar.

DONNÉES TECHNIQUES

Pression dynamique minimum 0,5 bar
Pression de service maximale de 5 bar
Pression d'utilisation conseillé de 1 à 5 bar
Température maximale de l'eau chaude 80 ° C

CARACTERISTIQUES GENERALES

Profondeur de montage de 80 mm à 90 mm.
Les entrées sont fournis avec filetage G1/2" femelle G3/4" mâle, les sorties G1/2"F (1,2,ou 3 voies).
La poignée de réglage de la température, est pré-réglée à 38 ° C Si à l'intérieur du système vous avez des pressions supérieures à 5 bars, il est recommandé l'utilisation d'un réducteur de pression..

Built-in part - Parte incasso - Corps encastré

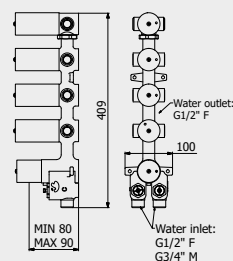

Plate and handles - Parte esterna - Plaque et poignée

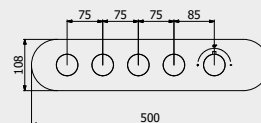
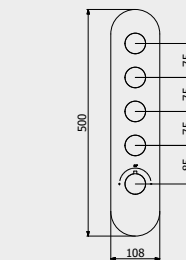

Plate and handles - Parte esterna - Plaque et poignée



PACKAGING

L: 440 mm D: 190 mm H: 165 mm 5,4 kg

ORIENTATION | ORIENTAZIONE | ORIENTATION

2 ways to Installation: horizontal or vertical
2 modalità di installazione: verticale o orizzontale
2 modalit  de installation: vertical ou horizontal.

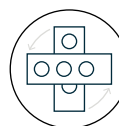

FOR ALL MODELS
PER TUTTI I MODELLI
POUR TOUS LES MODÈLES



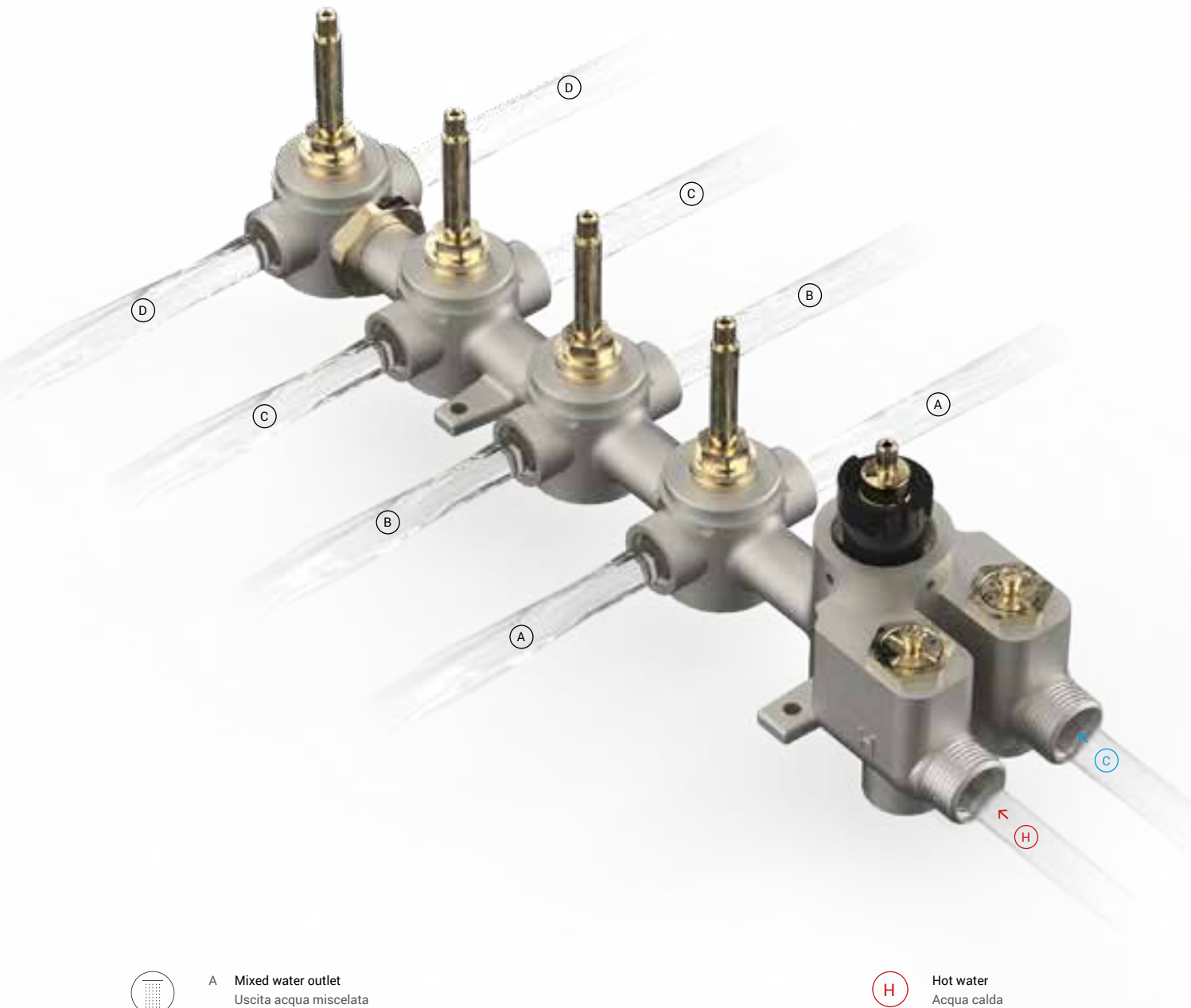

- A **Mixed water outlet**
Uscita acqua miscelata
Sortie eau mélangé
- B **Mixed water outlet**
Uscita acqua miscelata
Sortie eau mélangé
- C **Mixed water outlet**
Uscita acqua miscelata
Sortie eau mélangé
- D **Mixed water outlet**
Uscita acqua miscelata
Sortie eau mélangé

- H** **Hot water**
Acqua calda
Eau chaude
- C** **Cold water**
Acqua fredda
Eau froide

Aqua

PORTATE | WATER FLOW | DÉBIT D'EAU

0.2 BAR	0.5 BAR	1 BAR	2 BAR	3 BAR	4 BAR	5 BAR
10,7 l/m	18 l/m	26 l/m	37 l/m	45 l/m	51 l/m	56 l/m

Hey Joe!



RECESSED BODY
CORPO INCASSO
PARTIE ENCASTRÉ
IUA400CCXN_1 12,4

PACKAGING

L: 530 mm
D: 145 mm
H: 90 mm

4,86 kg



VERTICAL | VERTICALE | VERTICAL

PLATE AND HANDLES TRIMKIT
KIT PIASTRA E MANIGLIE
KIT PLAQUE ET POIGNÉE



CC	EUA412CCNHJ	32,1
SS	EUA412SSNHJ	40,2
BO	EUA412BONHJ	38,6
NP	EUA412NPNHJ	38,6
CF	EUA412CFNHJ	48,2
CS	EUA412CSNHJ	51,4
OO	EUA412OONHJ	48,2
II	EUA412IINHJ	48,2
IS	EUA412ISNHJ	51,4
RS	EUA412RSNHJ	48,2
SR	EUA412SRNHJ	51,4
OS	EUA412OSNHJ	51,4

HORIZONTAL | ORIZZONTALE | HORIZONTAL

PLATE AND HANDLES TRIMKIT
KIT PIASTRA E MANIGLIE
KIT PLAQUE ET POIGNÉE



CC	EUA422CCNHJ	32,1
SS	EUA422SSNHJ	40,2
BO	EUA422BONHJ	38,6
NP	EUA422NPNHJ	38,6
CF	EUA422CFNHJ	48,2
CS	EUA422CSNHJ	51,4
OO	EUA422OONHJ	48,2
II	EUA422IINHJ	48,2
IS	EUA422ISNHJ	51,4
RS	EUA422RSNHJ	48,2
SR	EUA422SRNHJ	51,4
OS	EUA422OSNHJ	51,4

Loveme



RECESSED BODY
CORPO INCASSO
PARTIE ENCASTRÉ
IUA400CCXN_1 12,4

PACKAGING

L: 530 mm
D: 145 mm
H: 90 mm

4,86 kg



VERTICAL | VERTICALE | VERTICAL

PLATE AND HANDLES TRIMKIT
KIT PIASTRA E MANIGLIE
KIT PLAQUE ET POIGNÉE



CC	EUA412CCNLM	32,1
SS	EUA412SSNLM	40,2
BO	EUA412BONLM	38,6
NP	EUA412NPNLM	38,6
CS	EUA412CSNLM	51,4
IS	EUA412ISNLM	51,4
SR	EUA412SRNLM	51,4
OS	EUA412OSNLM	51,4
ON	EUA412ONNLM	32,1

HORIZONTAL | ORIZZONTALE | HORIZONTAL

PLATE AND HANDLES TRIMKIT
KIT PIASTRA E MANIGLIE
KIT PLAQUE ET POIGNÉE



CC	EUA422CCNLM	32,1
SS	EUA422SSNLM	40,2
BO	EUA422BONLM	38,6
NP	EUA422NPNLM	38,6
CS	EUA422CSNLM	51,4
IS	EUA422ISNLM	51,4
SR	EUA422SRNLM	51,4
OS	EUA422OSNLM	51,4
ON	EUA422ONNLM	32,1

Belmondo



RECESSED BODY
CORPO INCASSO
PARTIE ENCASTRÉ
IUA400CCXN_1 12,4

PACKAGING

L: 530 mm
D: 145 mm
H: 90 mm

4,86 kg



VERTICAL | VERTICALE | VERTICAL

PLATE AND HANDLES TRIMKIT
KIT PIASTRA E MANIGLIE
KIT PLAQUE ET POIGNÉE



CC	EUA412CCNBT	32,1
OO	EUA412OONBT	48,2
II	EUA412IINBT	48,2
RS	EUA412RSNBT	48,2
PL	EUA412PLNBT	51,4

HORIZONTAL | ORIZZONTALE | HORIZONTAL

PLATE AND HANDLES TRIMKIT
KIT PIASTRA E MANIGLIE
KIT PLAQUE ET POIGNÉE



CC	EUA422CCNBT	32,1
OO	EUA422OONBT	48,2
II	EUA422IINBT	48,2
RS	EUA422RSNBT	48,2
PL	EUA422PLNBT	51,4

Batlò



RECESSED BODY
CORPO INCASSO
PARTIE ENCASTRÉ
IUA400CCXN_1 12,4

PACKAGING

L: 530 mm
D: 145 mm
H: 90 mm

4,86 kg



VERTICAL | VERTICALE | VERTICAL

PLATE AND HANDLES TRIMKIT
KIT PIASTRA E MANIGLIE
KIT PLAQUE ET POIGNÉE



CC	EUA412CCNBI	32,1
SS	EUA412SSNBI	40,2
BO	EUA412BONBI	38,6
NP	EUA412NPNBI	38,6
CF	EUA412CFNBI	48,2
CS	EUA412CSNBI	51,4
OO	EUA412OONBI	48,2
II	EUA412IINBI	48,2
IS	EUA412ISNBI	51,4
RS	EUA412RSNBI	48,2
SR	EUA412SRNBI	51,4
OS	EUA412OSNBI	51,4

HORIZONTAL | ORIZZONTALE | HORIZONTAL

PLATE AND HANDLES TRIMKIT
KIT PIASTRA E MANIGLIE
KIT PLAQUE ET POIGNÉE



CC	EUA422CCNBI	32,1
SS	EUA422SSNBI	40,2
BO	EUA422BONBI	38,6
NP	EUA422NPNBI	38,6
CF	EUA422CFNBI	48,2
CS	EUA422CSNBI	51,4
OO	EUA422OONBI	48,2
II	EUA422IINBI	48,2
IS	EUA422ISNBI	51,4
RS	EUA422RSNBI	48,2
SR	EUA422SRNBI	51,4
OS	EUA422OSNBI	51,4

Kusasi



RECESSED BODY
CORPO INCASSO
PARTIE ENCASTRÉ
IUA400CCXN_1 12,4

PACKAGING

L: 530 mm
D: 145 mm
H: 90 mm

4,86 kg



VERTICAL | VERTICALE | VERTICAL

PLATE AND HANDLES TRIMKIT
KIT PIASTRA E MANIGLIE
KIT PLAQUE ET POIGNÉE



CC	EUA412CCNKU	32,1
SS	EUA412SSNKU	40,2
NP	EUA412NPNKU	38,6

HORIZONTAL | ORIZZONTALE | HORIZONTAL

PLATE AND HANDLES TRIMKIT
KIT PIASTRA E MANIGLIE
KIT PLAQUE ET POIGNÉE



CC	EUA422CCNKU	32,1
SS	EUA422SSNKU	40,2
NP	EUA422NPNKU	38,6

Wow

RECESSED BODY
CORPO INCASSO
PARTIE ENCASTRÉ
IUA400CCXN_1 12,4



PACKAGING

L: 530 mm
D: 145 mm
H: 90 mm

4,86 kg

VERTICAL | VERTICALE | VERTICAL

PLATE AND HANDLES TRIMKIT
KIT PIASTRA E MANIGLIE
KIT PLAQUE ET POIGNÉE

CC	EUA412CCNWO	32,1
SS	EUA412SSNWO	40,2
BO	EUA412BONWO	38,6
NP	EUA412NPNWO	38,6
OO	EUA412OONWO	48,2

HORIZONTAL | ORIZZONTALE | HORIZONTAL

PLATE AND HANDLES TRIMKIT
KIT PIASTRA E MANIGLIE
KIT PLAQUE ET POIGNÉE

CC	EUA422CCNWO	32,1
SS	EUA422SSNWO	40,2
BO	EUA422BONWO	38,6
NP	EUA422NPNWO	38,6
OO	EUA422OONWO	48,2

Industria

RECESSED BODY
CORPO INCASSO
PARTIE ENCASTRÉ
IUA400CCXN_1 12,4



PACKAGING

L: 530 mm
D: 145 mm
H: 90 mm

4,86 kg

VERTICAL | VERTICALE | VERTICAL

PLATE AND HANDLES TRIMKIT
KIT PIASTRA E MANIGLIE
KIT PLAQUE ET POIGNÉE

CC	EUA412CCNID1	32,1
SS	EUA412SSNID1	40,2
NP	EUA412NPNID1	38,6
CF	EUA412CFNID1	48,2
CS	EUA412CSNID1	51,4
OO	EUA412OONID1	48,2
II	EUA412IINID1	48,2
IS	EUA412ISNID1	51,4
RS	EUA412RSNID1	48,2
SR	EUA412SRNID1	51,4
OS	EUA412OSNID1	51,4
ON	EUA412ONNID1	32,1

HORIZONTAL | ORIZZONTALE | HORIZONTAL

PLATE AND HANDLES TRIMKIT
KIT PIASTRA E MANIGLIE
KIT PLAQUE ET POIGNÉE

CC	EUA422CCNID1	32,1
SS	EUA422SSNID1	40,2
NP	EUA422NPNID1	38,6
CF	EUA422CFNID1	48,2
CS	EUA422CSNID1	51,4
OO	EUA422OONID1	48,2
II	EUA422IINID1	48,2
IS	EUA422ISNID1	51,4
RS	EUA422RSNID1	48,2
SR	EUA422SRNID1	51,4
OS	EUA422OSNID1	51,4
ON	EUA422ONNID1	32,1

Bold

RECESSED BODY
CORPO INCASSO
PARTIE ENCASTRÉ
IUA400CCXN_1 12,4



PACKAGING

L: 530 mm
D: 145 mm
H: 90 mm

4,86 kg

VERTICAL | VERTICALE | VERTICAL

PLATE AND HANDLES TRIMKIT
KIT PIASTRA E MANIGLIE
KIT PLAQUE ET POIGNÉE

CC	EUA412CCNB1	34,6
SS	EUA412SSNB1	43,3
NP	EUA412NPNB1	41,6
CF	EUA412CFNB1	52,0
CS	EUA412CSNB1	55,4
OO	EUA412OONB1	52,0
II	EUA412IINB1	52,0
IS	EUA412ISNB1	55,4
RS	EUA412RSNB1	52,0
SR	EUA412SRNB1	55,4
OS	EUA412OSNB1	55,4
ON	EUA412ONNB1	34,6

HORIZONTAL | ORIZZONTALE | HORIZONTAL

PLATE AND HANDLES TRIMKIT
KIT PIASTRA E MANIGLIE
KIT PLAQUE ET POIGNÉE

CC	EUA422CCNB1	34,6
SS	EUA422SSNB1	43,3
NP	EUA422NPNB1	41,6
CF	EUA422CFNB1	52,0
CS	EUA422CSNB1	55,4
OO	EUA422OONB1	52,0
II	EUA422IINB1	52,0
IS	EUA422ISNB1	55,4
RS	EUA422RSNB1	52,0
SR	EUA422SRNB1	55,4
OS	EUA422OSNB1	55,4
ON	EUA422ONNB1	34,6

Birkin

RECESSED BODY
CORPO INCASSO
PARTIE ENCASTRÉ
IUA400CCXN_1 12,4



PACKAGING

L: 530 mm
D: 145 mm
H: 90 mm

4,86 kg

VERTICAL | VERTICALE | VERTICAL

PLATE AND HANDLES TRIMKIT
KIT PIASTRA E MANIGLIE
KIT PLAQUE ET POIGNÉE

CC	EUA412CCNBR3	44,7
SS	EUA412SSNBR3	55,9
RS	EUA412RSNBR3	67,0
OS	EUA412OSNBR3	71,5
PL	EUA412PLNBR3	71,5

HORIZONTAL | ORIZZONTALE | HORIZONTAL

PLATE AND HANDLES TRIMKIT
KIT PIASTRA E MANIGLIE
KIT PLAQUE ET POIGNÉE

CC	EUA422CCNBR3	44,7
SS	EUA422SSNBR3	55,9
RS	EUA422RSNBR3	67,0
OS	EUA422OSNBR3	71,5
PL	EUA422PLNBR3	71,5

Marmo

RECESSED BODY
CORPO INCASSO
PARTIE ENCASTRÉ
IUA400CCXN_1 12,4



PACKAGING

L: 530 mm
D: 145 mm
H: 90 mm

5,06 kg

MARBLE

White Carrara

Black Marquina

VERTICAL | VERTICALE | VERTICAL

PLATE AND HANDLES TRIMKIT
KIT PIASTRA E MANIGLIE
KIT PLAQUE ET POIGNÉE

CC	EUA412CCNMR1	EUA412CCNMR2	40,8
SS	EUA412SSNMR1	EUA412SSNMR2	51,0
BO	EUA412BONMR1	EUA412BONMR2	48,9
NP	EUA412NPNMR1	EUA412NPNMR2	48,9
CF	EUA412CFNMR1	EUA412CFNMR2	61,1
CS	EUA412CSNMR1	EUA412CSNMR2	65,2
OO	EUA412OONMR1	EUA412OONMR2	61,1
II	EUA412IINMR1	EUA412IINMR2	61,1
IS	EUA412ISNMR1	EUA412ISNMR2	65,2
RS	EUA412RSNMR1	EUA412RSNMR2	61,1
SR	EUA412SRNMR1	EUA412SRNMR2	65,2
OS	EUA412OSNMR1	EUA412OSNMR2	65,2
ON	EUA412ONNMR1	EUA412PLNMR2	40,8
PL	EUA412PLNMR1	EUA412PLNMR2	65,2

HORIZONTAL | ORIZZONTALE | HORIZONTAL

PLATE AND HANDLES TRIMKIT
KIT PIASTRA E MANIGLIE
KIT PLAQUE ET POIGNÉE

CC	EUA422CCNMR1	EUA422CCNMR2	40,8
SS	EUA422SSNMR1	EUA422SSNMR2	51,0
BO	EUA422BONMR1	EUA422BONMR2	48,9
NP	EUA422NPNMR1	EUA422NPNMR2	48,9
CF	EUA422CFNMR1	EUA422CFNMR2	61,1
CS	EUA422CSNMR1	EUA422CSNMR2	65,2
OO	EUA422OONMR1	EUA422OONMR2	61,1
II	EUA422IINMR1	EUA422IINMR2	61,1
IS	EUA422ISNMR1	EUA422ISNMR2	65,2
RS	EUA422RSNMR1	EUA422RSNMR2	61,1
SR	EUA422SRNMR1	EUA422SRNMR2	65,2
OS	EUA422OSNMR1	EUA422OSNMR2	65,2
ON	EUA422ONNMR1	EUA422PLNMR2	40,8
PL	EUA422PLNMR1	EUA422PLNMR2	65,2

Aqua

Rubacuori



RECESSED BODY
CORPO INCASSO
PARTIE ENCASTRÉ
IUA400CCXN_1 12,4

PACKAGING

L: 530 mm
D: 145 mm
H: 90 mm

4,86 kg



VERTICAL | VERTICALE | VERTICAL

PLATE AND HANDLES TRIMKIT
KIT PIASTRA E MANIGLIE
KIT PLAQUE ET POIGNÉE

CC	EUA411CCNRU	32,1
SS	EUA411SSNRU	40,2
BO	EUA411BONRU	38,6
NP	EUA411NPNRU	38,6
CF	EUA411CFNRU	48,2
CS	EUA411CSNRU	51,4
OO	EUA411OONRU	48,2
II	EUA411IINRU	48,2
IS	EUA411ISNRU	51,4
RS	EUA411RSNRU	48,2
SR	EUA411SRNRU	51,4
OS	EUA411OSNRU	51,4

HORIZONTAL | ORIZZONTALE | HORIZONTAL

PLATE AND HANDLES TRIMKIT
KIT PIASTRA E MANIGLIE
KIT PLAQUE ET POIGNÉE

CC	EUA421CCNRU	32,1
SS	EUA421SSNRU	40,2
BO	EUA421BONRU	38,6
NP	EUA421NPNRU	38,6
CF	EUA421CFNRU	48,2
CS	EUA421CSNRU	51,4
OO	EUA421OONRU	48,2
II	EUA421IINRU	48,2
IS	EUA421ISNRU	51,4
RS	EUA421RSNRU	48,2
SR	EUA421SRNRU	51,4
OS	EUA421OSNRU	51,4

Hey joe!



RECESSED BODY
CORPO INCASSO
PARTIE ENCASTRÉ
IUA400CCXN_1 12,4

PACKAGING

L: 530 mm
D: 145 mm
H: 90 mm

4,86 kg



VERTICAL | VERTICALE | VERTICAL

PLATE AND HANDLES TRIMKIT
KIT PIASTRA E MANIGLIE
KIT PLAQUE ET POIGNÉE

CC	EUA411CCNHJ	32,1
SS	EUA411SSNHJ	40,2
BO	EUA411BONHJ	38,6
NP	EUA411NPNHJ	38,6
CF	EUA411CFNHJ	48,2
CS	EUA411CSNHJ	51,4
OO	EUA411OONHJ	48,2
II	EUA411IINHJ	48,2
IS	EUA411ISNHJ	51,4
RS	EUA411RSNHJ	48,2
SR	EUA411SRNHJ	51,4
OS	EUA411OSNHJ	51,4

HORIZONTAL | ORIZZONTALE | HORIZONTAL

PLATE AND HANDLES TRIMKIT
KIT PIASTRA E MANIGLIE
KIT PLAQUE ET POIGNÉE

CC	EUA421CCNHJ	32,1
SS	EUA421SSNHJ	40,2
BO	EUA421BONHJ	38,6
NP	EUA421NPNHJ	38,6
CF	EUA421CFNHJ	48,2
CS	EUA421CSNHJ	51,4
OO	EUA421OONHJ	48,2
II	EUA421IINHJ	48,2
IS	EUA421ISNHJ	51,4
RS	EUA421RSNHJ	48,2
SR	EUA421SRNHJ	51,4
OS	EUA421OSNHJ	51,4

Belmondo



RECESSED BODY
CORPO INCASSO
PARTIE ENCASTRÉ
IUA400CCXN_1 12,4

PACKAGING

L: 530 mm
D: 145 mm
H: 90 mm

4,86 kg



VERTICAL | VERTICALE | VERTICAL

PLATE AND HANDLES TRIMKIT
KIT PIASTRA E MANIGLIE
KIT PLAQUE ET POIGNÉE

CC	EUA411CCNBT	32,1
OO	EUA411OONBT	48,2
II	EUA411IINBT	48,2
RS	EUA411RSNBT	48,2
PL	EUA411PLNBT	51,4

HORIZONTAL | ORIZZONTALE | HORIZONTAL

PLATE AND HANDLES TRIMKIT
KIT PIASTRA E MANIGLIE
KIT PLAQUE ET POIGNÉE

CC	EUA421CCNBT	32,1
OO	EUA421OONBT	48,2
II	EUA421IINBT	48,2
RS	EUA421RSNBT	48,2
PL	EUA421PLNBT	51,4

Kusasi



RECESSED BODY
CORPO INCASSO
PARTIE ENCASTRÉ
IUA400CCXN_1 12,4

PACKAGING

L: 530 mm
D: 145 mm
H: 90 mm

4,86 kg



VERTICAL | VERTICALE | VERTICAL

PLATE AND HANDLES TRIMKIT
KIT PIASTRA E MANIGLIE
KIT PLAQUE ET POIGNÉE

CC	EUA411CCNKU	32,1
SS	EUA411SSNKU	40,2
NP	EUA411NPNKU	38,6

HORIZONTAL | ORIZZONTALE | HORIZONTAL

PLATE AND HANDLES TRIMKIT
KIT PIASTRA E MANIGLIE
KIT PLAQUE ET POIGNÉE

CC	EUA421CCNKU	32,1
SS	EUA421SSNKU	40,2
NP	EUA421NPNKU	38,6

Wow



RECESSED BODY
CORPO INCASSO
PARTIE ENCASTRÉ
IUA400CCXN_1 12,4

PACKAGING

L: 530 mm
D: 145 mm
H: 90 mm

4,86 kg



VERTICAL | VERTICALE | VERTICAL

PLATE AND HANDLES TRIMKIT
KIT PIASTRA E MANIGLIE
KIT PLAQUE ET POIGNÉE

CC	EUA411CCNWO	32,1
SS	EUA411SSNWO	40,2
BO	EUA411BONWO	38,6
NP	EUA411NPNWO	38,6
OO	EUA411OONWO	48,2

HORIZONTAL | ORIZZONTALE | HORIZONTAL

PLATE AND HANDLES TRIMKIT
KIT PIASTRA E MANIGLIE
KIT PLAQUE ET POIGNÉE

CC	EUA421CCNWO	32,1
SS	EUA421SSNWO	40,2
BO	EUA421BONWO	38,6
NP	EUA421NPNWO	38,6
OO	EUA421OONWO	48,2

Industria

RECESSED BODY
CORPO INCASSO
PARTIE ENCASTRÉ

IUA400CCXN_1 12,4



PACKAGING

L: 530 mm
D: 145 mm
H: 90 mm

4,86 kg

VERTICAL | VERTICALE | VERTICAL

PLATE AND HANDLES TRIMKIT
KIT PIASTRA E MANIGLIE
KIT PLAQUE ET POIGNÉE

CC	EUA411CCNID1	32,1
SS	EUA411SSNID1	40,2
NP	EUA411NPNID1	38,6
CF	EUA411CFNID1	48,2
CS	EUA411CSNID1	51,4
OO	EUA411OONID1	48,2
II	EUA411IINID1	48,2
IS	EUA411ISNID1	51,4
RS	EUA411RSNID1	48,2
SR	EUA411SRNID1	51,4
OS	EUA411OSNID1	51,4
ON	EUA411ONNID1	32,1

HORIZONTAL | ORIZZONTALE | HORIZONTAL

PLATE AND HANDLES TRIMKIT
KIT PIASTRA E MANIGLIE
KIT PLAQUE ET POIGNÉE

CC	EUA421CCNID1	32,1
SS	EUA421SSNID1	40,2
NP	EUA421NPNID1	38,6
CF	EUA421CFNID1	48,2
CS	EUA421CSNID1	51,4
OO	EUA421OONID1	48,2
II	EUA421IINID1	48,2
IS	EUA421ISNID1	51,4
RS	EUA421RSNID1	48,2
SR	EUA421SRNID1	51,4
OS	EUA421OSNID1	51,4
ON	EUA421ONNID1	32,1

Marmo

RECESSED BODY
CORPO INCASSO
PARTIE ENCASTRÉ

IUA400CCXN_1 12,4



PACKAGING

L: 530 mm
D: 145 mm
H: 90 mm

5,06 kg

MARBLE

White Carrara

Black Marquina



VERTICAL | VERTICALE | VERTICAL

PLATE AND HANDLES TRIMKIT
KIT PIASTRA E MANIGLIE
KIT PLAQUE ET POIGNÉE

CC	EUA411CCNMR1	EUA411CCNMR2	40,8
SS	EUA411SSNMR1	EUA411SSNMR2	51,0
BO	EUA411BONMR1	EUA411BONMR2	48,9
NP	EUA411NPNMR1	EUA411NPNMR2	48,9
CF	EUA411CFNMR1	EUA411CFNMR2	61,1
CS	EUA411CSNMR1	EUA411CSNMR2	65,2
OO	EUA411OONMR1	EUA411OONMR2	61,1
II	EUA411IINMR1	EUA411IINMR2	61,1
IS	EUA411ISNMR1	EUA411ISNMR2	65,2
RS	EUA411RSNMR1	EUA411RSNMR2	61,1
SR	EUA411SRNMR1	EUA411SRNMR2	65,2
OS	EUA411OSNMR1	EUA411OSNMR2	65,2
ON	EUA411ONNMR1	EUA411PLNMR2	40,8
PL	EUA411PLNMR1	EUA411PLNMR2	65,2

HORIZONTAL | ORIZZONTALE | HORIZONTAL

PLATE AND HANDLES TRIMKIT
KIT PIASTRA E MANIGLIE
KIT PLAQUE ET POIGNÉE

CC	EUA421CCNMR1	EUA421CCNMR2	40,8
SS	EUA421SSNMR1	EUA421SSNMR2	51,0
BO	EUA421BONMR1	EUA421BONMR2	48,9
NP	EUA421NPNMR1	EUA421NPNMR2	48,9
CF	EUA421CFNMR1	EUA421CFNMR2	61,1
CS	EUA421CSNMR1	EUA421CSNMR2	65,2
OO	EUA421OONMR1	EUA421OONMR2	61,1
II	EUA421IINMR1	EUA421IINMR2	61,1
IS	EUA421ISNMR1	EUA421ISNMR2	65,2
RS	EUA421RSNMR1	EUA421RSNMR2	61,1
SR	EUA421SRNMR1	EUA421SRNMR2	65,2
OS	EUA421OSNMR1	EUA421OSNMR2	65,2
ON	EUA421ONNMR1	EUA421PLNMR2	40,8
PL	EUA421PLNMR1	EUA421PLNMR2	65,2

Hermes

RECESSED BODY
CORPO INCASSO
PARTIE ENCASTRÉ

IUA400CCXN_1 12,4



PACKAGING

L: 530 mm
D: 145 mm
H: 90 mm

4,86 kg

VERTICAL | VERTICALE | VERTICAL

PLATE AND HANDLES TRIMKIT
KIT PIASTRA E MANIGLIE
KIT PLAQUE ET POIGNÉE

CC	EUA415CCNHR	32,5
SS	EUA415SSNHR	40,6
II	EUA415IINHR	48,8
RS	EUA415RSNHR	48,8
OS	EUA415OSNHR	52,0
RR	EUA415RRNHR	45,5
BB	EUA415BBNHR	45,5
PL	EUA415PLNHR	52,0

HORIZONTAL | ORIZZONTALE | HORIZONTAL

PLATE AND HANDLES TRIMKIT
KIT PIASTRA E MANIGLIE
KIT PLAQUE ET POIGNÉE

CC	EUA425CCNHR	32,5
SS	EUA425SSNHR	40,6
II	EUA425IINHR	48,8
RS	EUA425RSNHR	48,8
OS	EUA425OSNHR	52,0
RR	EUA425RRNHR	45,5
BB	EUA425BBNHR	45,5
PL	EUA425PLNHR	52,0

Birkin

RECESSED BODY
CORPO INCASSO
PARTIE ENCASTRÉ

IUA400CCXN_1 12,4



PACKAGING

L: 530 mm
D: 145 mm
H: 90 mm

4,86 kg

VERTICAL | VERTICALE | VERTICAL

PLATE AND HANDLES TRIMKIT
KIT PIASTRA E MANIGLIE
KIT PLAQUE ET POIGNÉE

CC	EUA415CCNBR3	44,7
SS	EUA415SSNBR3	55,9
RS	EUA415RSNBR3	67,0
OS	EUA415OSNBR3	71,5
PL	EUA415PLNBR3	71,5

HORIZONTAL | ORIZZONTALE | HORIZONTAL

PLATE AND HANDLES TRIMKIT
KIT PIASTRA E MANIGLIE
KIT PLAQUE ET POIGNÉE

CC	EUA425CCNBR3	44,7
SS	EUA425SSNBR3	55,9
RS	EUA425RSNBR3	67,0
OS	EUA425OSNBR3	71,5
PL	EUA425PLNBR3	71,5

Aqua

AQUA

Thermostatic 5 ways

Termostatico 5 vie
Thermostatique 5 voies

ARTICLE | ARTICOLO | ARTICLE

IUA500CCXN_1

Only the built-in 1½" thermostatic unit of compact size, horizontal / vertical installation
Solo parte incasso termostatico 1/2 " ingombro ridotto, installazione orizzontale / verticale.
Seulement partie encastré du thermostatique 1/2" économie d'espace, installation horizontale / vertical.

CODE / COEFFICIENT | CODICE / COEFFICIENTE | CODE / COEFFICIENT

14,0

TECHNICAL DATA

Minimum dynamic pressure 0,5 bar
Maximum operational pressure 5 bar
Recommended operational pressure da 1 a 5 bar
Maximum hot water temperature 80°C

GENERAL FEATURES

Installation depth from 80 mm to 90 mm.
The intakes are fitted with G1/2" female G3/4" Male threaded connection, the outlets only G1/2"F (1, 2 or 3 way).
The temperature regulator lever is pre-set at 38°C.
Use of a pressure reducer is recommended if pressures in the system exceed 5 bar.

DATI TECNICI

Pressione dinamica minima 0,5 bar
Pressione di esercizio massima 5 bar
Pressione di utilizzo raccomandata da 1 a 5 bar
Temperatura massima acqua calda 80°C

CARATTERISTICHE GENERALI

Profondità di installazione da 80 mm a 90 mm.
Le entrate vengono fornite con filetto G1/2" femmina G3/4" maschio, le uscite solo G1/2"F (1, 2 o 3 vie).
La maniglia di regolazione temperatura, viene pre-settata a 38°C.
Si raccomanda l'utilizzo di un riduttore di pressione, se all'interno dell'impianto, si hanno pressioni superiori a 5 bar.

DONNÉES TECHNIQUES

Pression dynamique minimum 0,5 bar
Pression de service maximale de 5 bar
Pression d'utilisation conseillé de 1 à 5 bar
Température maximale de l'eau chaude 80 ° C

CARACTERISTIQUES GENERALES

rofondeur de montage de 80 mm à 90 mm.
Les entrées sont fournis avec filetage G1/2" femelle G3/4" mâle, les sorties G1/2"F (1,2,ou 3 voies).
La poignée de réglage de la température, est pré-réglée à 38 ° C Si à l'intérieur du système vous avez des pressions supérieures à 5 bars, il est recommandé l'utilisation d'un réducteur de pression..

Built-in part - Parte incasso - Corps encastré

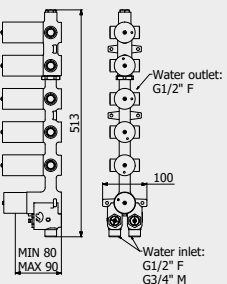

Plate and handles - Parte esterna - Plaque et poignée

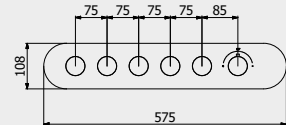
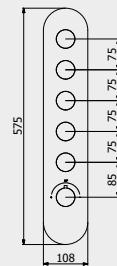

Plate and handles - Parte esterna - Plaque et poignée



PACKAGING

L: 530 mm D: 190 mm H: 165 mm 6,0 kg

ORIENTATION | ORIENTAZIONE | ORIENTATION

2 ways to Installation: horizontal or vertical
2 modalità di installazione: verticale o orizzontale
2 modalitè de installation: vertical ou horizontal.

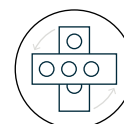

FOR ALL MODELS
PER TUTTI I MODELLI
POUR TOUS LES MODÈLES





- A Mixed water outlet**
Uscita acqua miscelata
Sortie eau mélangé
- B Mixed water outlet**
Uscita acqua miscelata
Sortie eau mélangé
- C Mixed water outlet**
Uscita acqua miscelata
Sortie eau mélangé

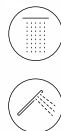

- D Mixed water outlet**
Uscita acqua miscelata
Sortie eau mélangé
- E Mixed water outlet**
Uscita acqua miscelata
Sortie eau mélangé



- H Hot water**
Acqua calda
Eau chaude
- C Cold water**
Acqua fredda
Eau froide

Aqua

PORTATE | WATER FLOW | DÉBIT D'EAU

0.2 BAR	0.5 BAR	1 BAR	2 BAR	3 BAR	4 BAR	5 BAR
10,7 l/m	18 l/m	26 l/m	37 l/m	45 l/m	51 l/m	56 l/m

Hey Joe!

RECESSED BODY
CORPO INCASSO
PARTIE ENCASTRÉ
IUA500CCXN_1 14,0



PACKAGING

L: 530 mm
D: 145 mm
H: 90 mm

5,26 kg



VERTICAL | VERTICALE | VERTICAL

PLATE AND HANDLES TRIMKIT
KIT PIASTRA E MANIGLIE
KIT PLAQUE ET POIGNÉE

CC	EUA512CCNHJ	37,4
SS	EUA512SSNHJ	46,7
BO	EUA512BONHJ	44,9
NP	EUA512NPNHJ	44,9
CF	EUA512CFNHJ	56,1
CS	EUA512CSNHJ	59,8
OO	EUA512OONHJ	56,1
II	EUA512IINHJ	56,1
IS	EUA512ISNHJ	59,8
RS	EUA512RSNHJ	56,1
SR	EUA512SRNHJ	59,8
OS	EUA512OSNHJ	59,8

HORIZONTAL | ORIZZONTALE | HORIZONTAL

PLATE AND HANDLES TRIMKIT
KIT PIASTRA E MANIGLIE
KIT PLAQUE ET POIGNÉE

CC	EUA522CCNHJ	37,4
SS	EUA522SSNHJ	46,7
BO	EUA522BONHJ	44,9
NP	EUA522NPNHJ	44,9
CF	EUA522CFNHJ	56,1
CS	EUA522CSNHJ	59,8
OO	EUA522OONHJ	56,1
II	EUA522IINHJ	56,1
IS	EUA522ISNHJ	59,8
RS	EUA522RSNHJ	56,1
SR	EUA522SRNHJ	59,8
OS	EUA522OSNHJ	59,8

Loveme

RECESSED BODY
CORPO INCASSO
PARTIE ENCASTRÉ
IUA500CCXN_1 14,0



PACKAGING

L: 530 mm
D: 145 mm
H: 90 mm

5,26 kg



VERTICAL | VERTICALE | VERTICAL

PLATE AND HANDLES TRIMKIT
KIT PIASTRA E MANIGLIE
KIT PLAQUE ET POIGNÉE

CC	EUA512CCNLM	37,4
SS	EUA512SSNLM	46,7
BO	EUA512BONLM	44,9
NP	EUA512NPNLM	44,9
CS	EUA512CSNLM	59,8
IS	EUA512ISNLM	59,8
SR	EUA512SRNLM	59,8
OS	EUA512OSNLM	59,8
ON	EUA512ONNLM	37,4

HORIZONTAL | ORIZZONTALE | HORIZONTAL

PLATE AND HANDLES TRIMKIT
KIT PIASTRA E MANIGLIE
KIT PLAQUE ET POIGNÉE

CC	EUA522CCNLM	37,4
SS	EUA522SSNLM	46,7
BO	EUA522BONLM	44,9
NP	EUA522NPNLM	44,9
CS	EUA522CSNLM	59,8
IS	EUA522ISNLM	59,8
SR	EUA522SRNLM	59,8
OS	EUA522OSNLM	59,8
ON	EUA522ONNLM	37,4

Belmondo

RECESSED BODY
CORPO INCASSO
PARTIE ENCASTRÉ
IUA500CCXN_1 14,0



PACKAGING

L: 530 mm
D: 145 mm
H: 90 mm

5,26 kg



VERTICAL | VERTICALE | VERTICAL

PLATE AND HANDLES TRIMKIT
KIT PIASTRA E MANIGLIE
KIT PLAQUE ET POIGNÉE

CC	EUA512CCNBT	37,4
OO	EUA512OONBT	56,1
II	EUA512IINBT	56,1
RS	EUA512RSNBT	56,1
PL	EUA512PLNBT	59,8

HORIZONTAL | ORIZZONTALE | HORIZONTAL

PLATE AND HANDLES TRIMKIT
KIT PIASTRA E MANIGLIE
KIT PLAQUE ET POIGNÉE

CC	EUA522CCNBT	37,4
OO	EUA522OONBT	56,1
II	EUA522IINBT	56,1
RS	EUA522RSNBT	56,1
PL	EUA522PLNBT	59,8

Batlò

RECESSED BODY
CORPO INCASSO
PARTIE ENCASTRÉ
IUA500CCXN_1 14,0



PACKAGING

L: 530 mm
D: 145 mm
H: 90 mm

5,26 kg



VERTICAL | VERTICALE | VERTICAL

PLATE AND HANDLES TRIMKIT
KIT PIASTRA E MANIGLIE
KIT PLAQUE ET POIGNÉE

CC	EUA512CCNBI	37,4
SS	EUA512SSNBI	46,7
BO	EUA512BONBI	44,9
NP	EUA512NPNBI	44,9
CF	EUA512CFNBI	56,1
CS	EUA512CSNBI	59,8
OO	EUA512OONBI	56,1
II	EUA512IINBI	56,1
IS	EUA512ISNBI	59,8
RS	EUA512RSNBI	56,1
SR	EUA512SRNBI	59,8
OS	EUA512OSNBI	59,8

HORIZONTAL | ORIZZONTALE | HORIZONTAL

PLATE AND HANDLES TRIMKIT
KIT PIASTRA E MANIGLIE
KIT PLAQUE ET POIGNÉE

CC	EUA522CCNBI	37,4
SS	EUA522SSNBI	46,7
BO	EUA522BONBI	44,9
NP	EUA522NPNBI	44,9
CF	EUA522CFNBI	56,1
CS	EUA522CSNBI	59,8
OO	EUA522OONBI	56,1
II	EUA522IINBI	56,1
IS	EUA522ISNBI	59,8
RS	EUA522RSNBI	56,1
SR	EUA522SRNBI	59,8
OS	EUA522OSNBI	59,8

Kusasi

RECESSED BODY
CORPO INCASSO
PARTIE ENCASTRÉ
IUA500CCXN_1 14,0



PACKAGING

L: 530 mm
D: 145 mm
H: 90 mm

5,26 kg



VERTICAL | VERTICALE | VERTICAL

PLATE AND HANDLES TRIMKIT
KIT PIASTRA E MANIGLIE
KIT PLAQUE ET POIGNÉE

CC	EUA512CCNKU	37,4
SS	EUA512SSNKU	46,7
NP	EUA512NPNKU	44,9

HORIZONTAL | ORIZZONTALE | HORIZONTAL

PLATE AND HANDLES TRIMKIT
KIT PIASTRA E MANIGLIE
KIT PLAQUE ET POIGNÉE

CC	EUA522CCNKU	37,4
SS	EUA522SSNKU	46,7
NP	EUA522NPNKU	44,9



Wow

RECESSED BODY
CORPO INCASSO
PARTIE ENCASTRÉ

IUA500CCXN_1 14,0



PACKAGING

L: 530 mm
D: 145 mm
H: 90 mm

5,26 kg

VERTICAL | VERTICALE | VERTICAL

PLATE AND HANDLES TRIMKIT
KIT PIASTRA E MANIGLIE
KIT PLAQUE ET POIGNÉE

	CC	EUA512CCNWO	37,4
	SS	EUA512SSNWO	46,7
	BO	EUA512BONWO	44,9
	NP	EUA512NPNWO	44,9
	OO	EUA512OONWO	56,1

HORIZONTAL | ORIZZONTALE | HORIZONTAL

PLATE AND HANDLES TRIMKIT
KIT PIASTRA E MANIGLIE
KIT PLAQUE ET POIGNÉE

	CC	EUA522CCNWO	37,4
	SS	EUA522SSNWO	46,7
	BO	EUA522BONWO	44,9
	NP	EUA522NPNWO	44,9
	OO	EUA522OONWO	56,1

Industria

RECESSED BODY
CORPO INCASSO
PARTIE ENCASTRÉ

IUA500CCXN_1 14,0



PACKAGING

L: 530 mm
D: 145 mm
H: 90 mm

5,26 kg

VERTICAL | VERTICALE | VERTICAL

PLATE AND HANDLES TRIMKIT
KIT PIASTRA E MANIGLIE
KIT PLAQUE ET POIGNÉE

	CC	EUA512CCNID1	37,4
	SS	EUA512SSNID1	46,7
	NP	EUA512NPNID1	44,9
	CF	EUA512CFNID1	56,1
	CS	EUA512CSNID1	59,8
	OO	EUA512OONID1	56,1
	II	EUA512IINID1	56,1
	IS	EUA512ISNID1	59,8
	RS	EUA512RSNID1	56,1
	SR	EUA512SRNID1	59,8
	OS	EUA512OSNID1	59,8
	ON	EUA512ONNID1	37,4

HORIZONTAL | ORIZZONTALE | HORIZONTAL

PLATE AND HANDLES TRIMKIT
KIT PIASTRA E MANIGLIE
KIT PLAQUE ET POIGNÉE

	CC	EUA522CCNID1	37,4
	SS	EUA522SSNID1	46,7
	NP	EUA522NPNID1	44,9
	CF	EUA522CFNID1	56,1
	CS	EUA522CSNID1	59,8
	OO	EUA522OONID1	56,1
	II	EUA522IINID1	56,1
	IS	EUA522ISNID1	59,8
	RS	EUA522RSNID1	56,1
	SR	EUA522SRNID1	59,8
	OS	EUA522OSNID1	59,8
	ON	EUA522ONNID1	37,4

Bold

RECESSED BODY
CORPO INCASSO
PARTIE ENCASTRÉ

IUA500CCXN_1 14,0



PACKAGING

L: 530 mm
D: 145 mm
H: 90 mm

5,26 kg

VERTICAL | VERTICALE | VERTICAL

PLATE AND HANDLES TRIMKIT
KIT PIASTRA E MANIGLIE
KIT PLAQUE ET POIGNÉE

	CC	EUA512CCNB1	40,4
	SS	EUA512SSNB1	50,5
	NP	EUA512NPNB1	48,5
	CF	EUA512CFNB1	60,7
	CS	EUA512CSNB1	64,7
	OO	EUA512OONB1	60,7
	II	EUA512IINB1	60,7
	IS	EUA512ISNB1	64,7
	RS	EUA512RSNB1	60,7
	SR	EUA512SRNB1	64,7
	OS	EUA512OSNB1	64,7
	ON	EUA512ONNB1	40,4

HORIZONTAL | ORIZZONTALE | HORIZONTAL

PLATE AND HANDLES TRIMKIT
KIT PIASTRA E MANIGLIE
KIT PLAQUE ET POIGNÉE

	CC	EUA522CCNB1	40,4
	SS	EUA522SSNB1	50,5
	NP	EUA522NPNB1	48,5
	CF	EUA522CFNB1	60,7
	CS	EUA522CSNB1	64,7
	OO	EUA522OONB1	60,7
	II	EUA522IINB1	60,7
	IS	EUA522ISNB1	64,7
	RS	EUA522RSNB1	60,7
	SR	EUA522SRNB1	64,7
	OS	EUA522OSNB1	64,7
	ON	EUA522ONNB1	40,4

Birkin

RECESSED BODY
CORPO INCASSO
PARTIE ENCASTRÉ

IUA500CCXN_1 14,0



PACKAGING

L: 530 mm
D: 145 mm
H: 90 mm

5,26 kg

VERTICAL | VERTICALE | VERTICAL

PLATE AND HANDLES TRIMKIT
KIT PIASTRA E MANIGLIE
KIT PLAQUE ET POIGNÉE

	CC	EUA512CCNBR3	52,4
	SS	EUA512SSNBR3	65,5
	RS	EUA512RSNBR3	78,7
	OS	EUA512OSNBR3	83,9
	PL	EUA512PLNBR3	83,9

HORIZONTAL | ORIZZONTALE | HORIZONTAL

PLATE AND HANDLES TRIMKIT
KIT PIASTRA E MANIGLIE
KIT PLAQUE ET POIGNÉE

	CC	EUA522CCNBR3	52,4
	SS	EUA522SSNBR3	65,5
	RS	EUA522RSNBR3	78,7
	OS	EUA522OSNBR3	83,9
	PL	EUA522PLNBR3	83,9

Marmo

RECESSED BODY
CORPO INCASSO
PARTIE ENCASTRÉ

IUA500CCXN_1 14,0



PACKAGING

L: 530 mm
D: 145 mm
H: 90 mm

5,50 kg

MARBLE

White Carrara

Black Marquina

VERTICAL | VERTICALE | VERTICAL

PLATE AND HANDLES TRIMKIT
KIT PIASTRA E MANIGLIE
KIT PLAQUE ET POIGNÉE

	CC	EUA512CCNMR1	EUA512CCNMR2	47,8
	SS	EUA512SSNMR1	EUA512SSNMR2	59,8
	BO	EUA512BONMR1	EUA512BONMR2	57,4
	NP	EUA512NPNMR1	EUA512NPNMR2	57,4
	CF	EUA512CFNMR1	EUA512CFNMR2	71,7
	CS	EUA512CSNMR1	EUA512CSNMR2	76,5
	OO	EUA512OONMR1	EUA512OONMR2	71,7
	II	EUA512IINMR1	EUA512IINMR2	71,7
	IS	EUA512ISNMR1	EUA512ISNMR2	76,5
	RS	EUA512RSNMR1	EUA512RSNMR2	71,7
	SR	EUA512SRNMR1	EUA512SRNMR2	76,5
	OS	EUA512OSNMR1	EUA512OSNMR2	76,5
	ON	EUA512ONNMR1	EUA512PLNMR2	47,8
	PL	EUA512PLNMR1	EUA512PLNMR2	76,5

HORIZONTAL | ORIZZONTALE | HORIZONTAL

PLATE AND HANDLES TRIMKIT
KIT PIASTRA E MANIGLIE
KIT PLAQUE ET POIGNÉE

	CC	EUA522CCNMR1	EUA522CCNMR2	47,8
	SS	EUA522SSNMR1	EUA522SSNMR2	59,8
	BO	EUA522BONMR1	EUA522BONMR2	57,4
	NP	EUA522NPNMR1	EUA522NPNMR2	57,4
	CF	EUA522CFNMR1	EUA522CFNMR2	71,7
	CS	EUA522CSNMR1	EUA522CSNMR2	76,5
	OO	EUA522OONMR1	EUA522OONMR2	71,7
	II	EUA522IINMR1	EUA522IINMR2	71,7
	IS	EUA522ISNMR1	EUA522ISNMR2	76,5
	RS	EUA522RSNMR1	EUA522RSNMR2	71,7
	SR	EUA522SRNMR1	EUA522SRNMR2	76,5
	OS	EUA522OSNMR1	EUA522OSNMR2	76,5
	ON	EUA522ONNMR1	EUA522PLNMR2	47,8
	PL	EUA522PLNMR1	EUA522PLNMR2	76,5

Aqua

Rubacuori

RECESSED BODY
CORPO INCASSO
PARTIE ENCASTRÉ
IUA500CCXN_1 14,0



PACKAGING

L: 530 mm
D: 145 mm
H: 90 mm

5,26 kg



VERTICAL | VERTICALE | VERTICAL

PLATE AND HANDLES TRIMKIT
KIT PIASTRA E MANIGLIE
KIT PLAQUE ET POIGNÉE

CC	EUA511CCNRU	37,4
SS	EUA511SSNRU	46,7
BO	EUA511BONRU	44,9
NP	EUA511NPNRU	44,9
CF	EUA511CFNRU	56,1
CS	EUA511CSNRU	59,8
OO	EUA511OONRU	56,1
II	EUA511IINRU	56,1
IS	EUA511ISNRU	59,8
RS	EUA511RSNRU	56,1
SR	EUA511SRNRU	59,8
OS	EUA511OSNRU	59,8

HORIZONTAL | ORIZZONTALE | HORIZONTAL

PLATE AND HANDLES TRIMKIT
KIT PIASTRA E MANIGLIE
KIT PLAQUE ET POIGNÉE

CC	EUA521CCNRU	37,4
SS	EUA521SSNRU	46,7
BO	EUA521BONRU	44,9
NP	EUA521NPNRU	44,9
CF	EUA521CFNRU	56,1
CS	EUA521CSNRU	59,8
OO	EUA521OONRU	56,1
II	EUA521IINRU	56,1
IS	EUA521ISNRU	59,8
RS	EUA521RSNRU	56,1
SR	EUA521SRNRU	59,8
OS	EUA521OSNRU	59,8

Hey joe!

RECESSED BODY
CORPO INCASSO
PARTIE ENCASTRÉ
IUA500CCXN_1 14,0



PACKAGING

L: 530 mm
D: 145 mm
H: 90 mm

5,26 kg



VERTICAL | VERTICALE | VERTICAL

PLATE AND HANDLES TRIMKIT
KIT PIASTRA E MANIGLIE
KIT PLAQUE ET POIGNÉE

CC	EUA511CCNHJ	37,4
SS	EUA511SSNHJ	46,7
BO	EUA511BONHJ	44,9
NP	EUA511NPNHJ	44,9
CF	EUA511CFNHJ	56,1
CS	EUA511CSNHJ	59,8
OO	EUA511OONHJ	56,1
II	EUA511IINHJ	56,1
IS	EUA511ISNHJ	59,8
RS	EUA511RSNHJ	56,1
SR	EUA511SRNHJ	59,8
OS	EUA511OSNHJ	59,8

HORIZONTAL | ORIZZONTALE | HORIZONTAL

PLATE AND HANDLES TRIMKIT
KIT PIASTRA E MANIGLIE
KIT PLAQUE ET POIGNÉE

CC	EUA521CCNHJ	37,4
SS	EUA521SSNHJ	46,7
BO	EUA521BONHJ	44,9
NP	EUA521NPNHJ	44,9
CF	EUA521CFNHJ	56,1
CS	EUA521CSNHJ	59,8
OO	EUA521OONHJ	56,1
II	EUA521IINHJ	56,1
IS	EUA521ISNHJ	59,8
RS	EUA521RSNHJ	56,1
SR	EUA521SRNHJ	59,8
OS	EUA521OSNHJ	59,8

Belmondo

RECESSED BODY
CORPO INCASSO
PARTIE ENCASTRÉ
IUA500CCXN_1 14,0



PACKAGING

L: 530 mm
D: 145 mm
H: 90 mm

5,26 kg



VERTICAL | VERTICALE | VERTICAL

PLATE AND HANDLES TRIMKIT
KIT PIASTRA E MANIGLIE
KIT PLAQUE ET POIGNÉE

CC	EUA511CCNBT	37,4
OO	EUA511OONBT	56,1
II	EUA511IINBT	56,1
RS	EUA511RSNBT	56,1
PL	EUA511PLNBT	59,8

HORIZONTAL | ORIZZONTALE | HORIZONTAL

PLATE AND HANDLES TRIMKIT
KIT PIASTRA E MANIGLIE
KIT PLAQUE ET POIGNÉE

CC	EUA521CCNBT	37,4
OO	EUA521OONBT	56,1
II	EUA521IINBT	56,1
RS	EUA521RSNBT	56,1
PL	EUA521PLNBT	59,8

Kusasi

RECESSED BODY
CORPO INCASSO
PARTIE ENCASTRÉ
IUA500CCXN_1 14,0



PACKAGING

L: 530 mm
D: 145 mm
H: 90 mm

5,26 kg



VERTICAL | VERTICALE | VERTICAL

PLATE AND HANDLES TRIMKIT
KIT PIASTRA E MANIGLIE
KIT PLAQUE ET POIGNÉE

CC	EUA511CCNKU	37,4
SS	EUA511SSNKU	46,7
NP	EUA511NPNKU	44,9

HORIZONTAL | ORIZZONTALE | HORIZONTAL

PLATE AND HANDLES TRIMKIT
KIT PIASTRA E MANIGLIE
KIT PLAQUE ET POIGNÉE

CC	EUA521CCNKU	37,4
SS	EUA521SSNKU	46,7
NP	EUA521NPNKU	44,9

Wow

RECESSED BODY
CORPO INCASSO
PARTIE ENCASTRÉ
IUA500CCXN_1 14,0



PACKAGING

L: 530 mm
D: 145 mm
H: 90 mm

5,26 kg



VERTICAL | VERTICALE | VERTICAL

PLATE AND HANDLES TRIMKIT
KIT PIASTRA E MANIGLIE
KIT PLAQUE ET POIGNÉE

CC	EUA511CCNWO	37,4
SS	EUA511SSNWO	46,7
BO	EUA511BONWO	44,9
NP	EUA511NPNWO	44,9
OO	EUA511OONWO	56,1

HORIZONTAL | ORIZZONTALE | HORIZONTAL

PLATE AND HANDLES TRIMKIT
KIT PIASTRA E MANIGLIE
KIT PLAQUE ET POIGNÉE

CC	EUA521CCNWO	37,4
SS	EUA521SSNWO	46,7
BO	EUA521BONWO	44,9
NP	EUA521NPNWO	44,9
OO	EUA521OONWO	56,1



Industria

RECESSED BODY
CORPO INCASSO
PARTIE ENCASTRÉ

IUA500CCXN_1 14,0



PACKAGING

L: 530 mm
D: 145 mm
H: 90 mm

5,26 kg

VERTICAL | VERTICALE | VERTICAL

PLATE AND HANDLES TRIMKIT
KIT PIASTRA E MANIGLIE
KIT PLAQUE ET POIGNÉE

CC	EUA511CCNID1	37,4
SS	EUA511SSNID1	46,7
NP	EUA511NPNID1	44,9
CF	EUA511CFNID1	56,1
CS	EUA511CSNID1	59,8
OO	EUA511OONID1	56,1
II	EUA511IINID1	56,1
IS	EUA511ISNID1	59,8
RS	EUA511RSNID1	56,1
SR	EUA511SRNID1	59,8
OS	EUA511OSNID1	59,8
ON	EUA511ONNID1	37,4

HORIZONTAL | ORIZZONTALE | HORIZONTAL

PLATE AND HANDLES TRIMKIT
KIT PIASTRA E MANIGLIE
KIT PLAQUE ET POIGNÉE

CC	EUA521CCNID1	37,4
SS	EUA521SSNID1	46,7
NP	EUA521NPNID1	44,9
CF	EUA521CFNID1	56,1
CS	EUA521CSNID1	59,8
OO	EUA521OONID1	56,1
II	EUA521IINID1	56,1
IS	EUA521ISNID1	59,8
RS	EUA521RSNID1	56,1
SR	EUA521SRNID1	59,8
OS	EUA521OSNID1	59,8
ON	EUA521ONNID1	37,4

Marmo

RECESSED BODY
CORPO INCASSO
PARTIE ENCASTRÉ

IUA500CCXN_1 14,0



PACKAGING

L: 530 mm
D: 145 mm
H: 90 mm

5,50 kg

MARBLE

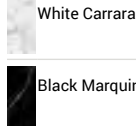

White Carrara

Black Marquina

VERTICAL | VERTICALE | VERTICAL

PLATE AND HANDLES TRIMKIT
KIT PIASTRA E MANIGLIE
KIT PLAQUE ET POIGNÉE

CC	EUA511CCNMR1	EUA511CCNMR2	47,8
SS	EUA511SSNMR1	EUA511SSNMR2	59,8
BO	EUA511BONMR1	EUA511BONMR2	57,4
NP	EUA511NPNMR1	EUA511NPNMR2	57,4
CF	EUA511CFNMR1	EUA511CFNMR2	71,7
CS	EUA511CSNMR1	EUA511CSNMR2	76,5
OO	EUA511OONMR1	EUA511OONMR2	71,7
II	EUA511IINMR1	EUA511IINMR2	71,7
IS	EUA511ISNMR1	EUA511ISNMR2	76,5
RS	EUA511RSNMR1	EUA511RSNMR2	71,7
SR	EUA511SRNMR1	EUA511SRNMR2	76,5
OS	EUA511OSNMR1	EUA511OSNMR2	76,5
ON	EUA511ONNMR1	EUA511PLNMR2	47,8
PL	EUA511PLNMR1	EUA511PLNMR2	76,5

HORIZONTAL | ORIZZONTALE | HORIZONTAL

PLATE AND HANDLES TRIMKIT
KIT PIASTRA E MANIGLIE
KIT PLAQUE ET POIGNÉE

CC	EUA521CCNMR1	EUA521CCNMR2	47,8
SS	EUA521SSNMR1	EUA521SSNMR2	59,8
BO	EUA521BONMR1	EUA521BONMR2	57,4
NP	EUA521NPNMR1	EUA521NPNMR2	57,4
CF	EUA521CFNMR1	EUA521CFNMR2	71,7
CS	EUA521CSNMR1	EUA521CSNMR2	76,5
OO	EUA521OONMR1	EUA521OONMR2	71,7
II	EUA521IINMR1	EUA521IINMR2	71,7
IS	EUA521ISNMR1	EUA521ISNMR2	76,5
RS	EUA521RSNMR1	EUA521RSNMR2	71,7
SR	EUA521SRNMR1	EUA521SRNMR2	76,5
OS	EUA521OSNMR1	EUA521OSNMR2	76,5
ON	EUA521ONNMR1	EUA521PLNMR2	47,8
PL	EUA521PLNMR1	EUA521PLNMR2	76,5

Hermes

RECESSED BODY
CORPO INCASSO
PARTIE ENCASTRÉ

IUA500CCXN_1 14,0



PACKAGING

L: 530 mm
D: 145 mm
H: 90 mm

5,26 kg

VERTICAL | VERTICALE | VERTICAL

PLATE AND HANDLES TRIMKIT
KIT PIASTRA E MANIGLIE
KIT PLAQUE ET POIGNÉE

CC	EUA515CCNHR	37,8
SS	EUA515SSNHR	47,3
II	EUA515IINHR	56,7
RS	EUA515RSNHR	56,7
OS	EUA515OSNHR	60,5
RR	EUA515RRNHR	52,9
BB	EUA515BBNHR	52,9
PL	EUA515PLNHR	60,5

HORIZONTAL | ORIZZONTALE | HORIZONTAL

PLATE AND HANDLES TRIMKIT
KIT PIASTRA E MANIGLIE
KIT PLAQUE ET POIGNÉE

CC	EUA525CCNHR	37,8
SS	EUA525SSNHR	47,3
II	EUA525IINHR	56,7
RS	EUA525RSNHR	56,7
OS	EUA525OSNHR	60,5
RR	EUA525RRNHR	52,9
BB	EUA525BBNHR	52,9
PL	EUA525PLNHR	60,5

Birkin

RECESSED BODY
CORPO INCASSO
PARTIE ENCASTRÉ

IUA500CCXN_1 14,0



PACKAGING

L: 530 mm
D: 145 mm
H: 90 mm

5,26 kg

VERTICAL | VERTICALE | VERTICAL

PLATE AND HANDLES TRIMKIT
KIT PIASTRA E MANIGLIE
KIT PLAQUE ET POIGNÉE

CC	EUA515CCNBR3	52,4
SS	EUA515SSNBR3	65,5
RS	EUA515RSNBR3	78,7
OS	EUA515OSNBR3	83,9
PL	EUA515PLNBR3	83,9

HORIZONTAL | ORIZZONTALE | HORIZONTAL

PLATE AND HANDLES TRIMKIT
KIT PIASTRA E MANIGLIE
KIT PLAQUE ET POIGNÉE

CC	EUA525CCNBR3	52,4
SS	EUA525SSNBR3	65,5
RS	EUA525RSNBR3	78,7
OS	EUA525OSNBR3	83,9
PL	EUA525PLNBR3	83,9

Aqua

AQUA

Diverter 2 ways

2 Vie con deviatore
2 voies avec déviateur

ARTICLE | ARTICOLO | ARTICLE

IUA002CCXN_1

Only the built-in 1\2" thermostatic unit of compact size, horizontal / vertical installation
Solo parte incasso termostatico 1/2 " ingombro ridotto, installazione orizzontale / verticale.
Seulement partie encastré du thermostatique 1/2" économie d'espace, installation horizontale / vertical.

CODE / COEFFICIENT | CODICE / COEFFICIENTE | CODE / COEFFICIENT

8,8

TECHNICAL DATA

Minimum dynamic pressure 0,5 bar
Maximum operational pressure 5 bar
Recommended operational pressure da 1 a 5 bar
Maximum hot water temperature 80°C

GENERAL FEATURES

Installation depth from 80 mm to 90 mm.
The intakes are fitted with G1/2" AU G3/4" M female threaded connection, the outlets only G1/2" F (1, 2 or 3 way).
The temperature regulator lever is pre-set at 38°C.
Use of a pressure reducer is recommended if pressures in the system exceed 5 bar.

DATI TECNICI

Pressione dinamica minima 0,5 bar
Pressione di esercizio massima 5 bar
Pressione di utilizzo raccomandata da 1 a 5 bar
Temperatura massima acqua calda 80°C

CARATTERISTICHE GENERALI

Profondità di installazione da 80 mm a 90 mm.
Le entrate vengono fornite con filetto G1/2" femmina G3/4" maschio, le uscite solo G1/2" F (1, 2 o 3 vie).
La maniglia di regolazione temperatura, viene pre-settata a 38°C.
Si raccomanda l'utilizzo di un riduttore di pressione, se all'interno dell'impianto, si hanno pressioni superiori a 5 bar.

DONNÉES TECHNIQUES

Pression dynamique minimum 0,5 bar
Pression de service maximale de 5 bar
Pression d'utilisation conseillé de 1 à 5 bar
Température maximale de l'eau chaude 80 ° C

CARACTERISTIQUES GENERALES

Profondeur de montage de 80 mm à 90 mm.
Les entrées sont fournis avec filetage G1/2" femelle G3/4" mâle, les sorties G1/2" F (1,2,ou 3 voies).
La poignée de réglage de la température, est pré-réglée à 38 ° C Si à l'intérieur du système vous avez des pressions supérieures à 5 bars, il est recommandé l'utilisation d'un réducteur de pression..

Built-in part - Parte incasso - Corps encastré

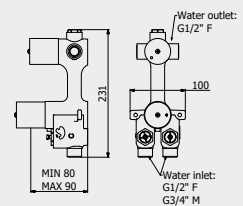

Plate and handles - Parte esterna - Plaque et poignée

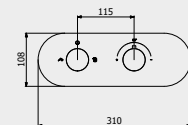
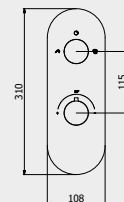



Plate and handles - Parte esterna - Plaque et poignée



PACKAGING

 L: 240 mm D: 115 mm H: 160 mm  3,4 kg

ORIENTATION | ORIENTAZIONE | ORIENTATION

2 ways to installation: horizontal or vertical
2 modalità di installazione: verticale o orizzontale
2 modalités de installation: vertical ou horizontal.

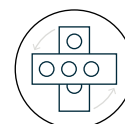

FOR ALL MODELS
PER TUTTI I MODELLI
POUR TOUS LES MODÈLES





A Mixed water outlet
Uscita acqua miscelata
Sortie eau mélangé



B Mixed water outlet
Uscita acqua miscelata
Sortie eau mélangé



H Hot water
Acqua calda
Eau chaude



C Cold water
Acqua fredda
Eau froide

Aqua

PORTATE | WATER FLOW | DÉBIT D'EAU

0.2 BAR	0.5 BAR	1 BAR	2 BAR	3 BAR	4 BAR	5 BAR
10,7 l/m	18 l/m	26 l/m	37 l/m	45 l/m	51 l/m	56 l/m

Hey Joe!



RECESSED BODY
CORPO INCASSO
PARTIE ENCASTRÉ
IUA002CCXN_1 8,8

PACKAGING

L: 530 mm
D: 145 mm
H: 90 mm

4,16 kg



VERTICAL | VERTICALE | VERTICAL

PLATE AND HANDLES TRIMKIT
KIT PIASTRA E MANIGLIE
KIT PLAQUE ET POIGNÉE

CC	EUA612CCNHJ	17,3
SS	EUA612SSNHJ	21,6
BO	EUA612BONHJ	20,8
NP	EUA612NPNHJ	20,8
CF	EUA612CFNHJ	26,0
CS	EUA612CSNHJ	27,7
OO	EUA612OONHJ	26,0
II	EUA612IINHJ	26,0
IS	EUA612ISNHJ	27,7
RS	EUA612RSNHJ	26,0
SR	EUA612SRNHJ	27,7
OS	EUA612OSNHJ	27,7

HORIZONTAL | ORIZZONTALE | HORIZONTAL

PLATE AND HANDLES TRIMKIT
KIT PIASTRA E MANIGLIE
KIT PLAQUE ET POIGNÉE

CC	EUA622CCNHJ	17,3
SS	EUA622SSNHJ	21,6
BO	EUA622BONHJ	20,8
NP	EUA622NPNHJ	20,8
CF	EUA622CFNHJ	26,0
CS	EUA622CSNHJ	27,7
OO	EUA622OONHJ	26,0
II	EUA622IINHJ	26,0
IS	EUA622ISNHJ	27,7
RS	EUA622RSNHJ	26,0
SR	EUA622SRNHJ	27,7
OS	EUA622OSNHJ	27,7

Loveme



RECESSED BODY
CORPO INCASSO
PARTIE ENCASTRÉ
IUA002CCXN_1 8,8

PACKAGING

L: 530 mm
D: 145 mm
H: 90 mm

4,16 kg



VERTICAL | VERTICALE | VERTICAL

PLATE AND HANDLES TRIMKIT
KIT PIASTRA E MANIGLIE
KIT PLAQUE ET POIGNÉE

CC	EUA612CCNLM	17,3
SS	EUA612SSNLM	21,6
BO	EUA612BONLM	20,8
NP	EUA612NPNLM	20,8
CS	EUA612CSNLM	27,7
IS	EUA612ISNLM	27,7
SR	EUA612SRNLM	27,7
OS	EUA612OSNLM	27,7
ON	EUA612ONNLM	17,3

HORIZONTAL | ORIZZONTALE | HORIZONTAL

PLATE AND HANDLES TRIMKIT
KIT PIASTRA E MANIGLIE
KIT PLAQUE ET POIGNÉE

CC	EUA622CCNLM	17,3
SS	EUA622SSNLM	21,6
BO	EUA622BONLM	20,8
NP	EUA622NPNLM	20,8
CS	EUA622CSNLM	27,7
IS	EUA622ISNLM	27,7
SR	EUA622SRNLM	27,7
OS	EUA622OSNLM	27,7
ON	EUA622ONNLM	17,3

Belmondo



RECESSED BODY
CORPO INCASSO
PARTIE ENCASTRÉ
IUA002CCXN_1 8,8

PACKAGING

L: 530 mm
D: 145 mm
H: 90 mm

4,16 kg



VERTICAL | VERTICALE | VERTICAL

PLATE AND HANDLES TRIMKIT
KIT PIASTRA E MANIGLIE
KIT PLAQUE ET POIGNÉE

CC	EUA612CCNBT	17,3
OO	EUA612OONBT	26,0
II	EUA612IINBT	26,0
RS	EUA612RSNBT	26,0
PL	EUA612PLNBT	27,7

HORIZONTAL | ORIZZONTALE | HORIZONTAL

PLATE AND HANDLES TRIMKIT
KIT PIASTRA E MANIGLIE
KIT PLAQUE ET POIGNÉE

CC	EUA622CCNBT	17,3
OO	EUA622OONBT	26,0
II	EUA622IINBT	26,0
RS	EUA622RSNBT	26,0
PL	EUA622PLNBT	27,7

Batlò



RECESSED BODY
CORPO INCASSO
PARTIE ENCASTRÉ
IUA002CCXN_1 8,8

PACKAGING

L: 530 mm
D: 145 mm
H: 90 mm

4,16 kg



VERTICAL | VERTICALE | VERTICAL

PLATE AND HANDLES TRIMKIT
KIT PIASTRA E MANIGLIE
KIT PLAQUE ET POIGNÉE

CC	EUA612CCNBI	17,3
SS	EUA612SSNBI	21,6
BO	EUA612BONBI	20,8
NP	EUA612NPNBI	20,8
CF	EUA612CFNBI	26,0
CS	EUA612CSNBI	27,7
OO	EUA612OONBI	26,0
II	EUA612IINBI	26,0
IS	EUA612ISNBI	27,7
RS	EUA612RSNBI	26,0
SR	EUA612SRNBI	27,7
OS	EUA612OSNBI	27,7

HORIZONTAL | ORIZZONTALE | HORIZONTAL

PLATE AND HANDLES TRIMKIT
KIT PIASTRA E MANIGLIE
KIT PLAQUE ET POIGNÉE

CC	EUA622CCNBI	17,3
SS	EUA622SSNBI	21,6
BO	EUA622BONBI	20,8
NP	EUA622NPNBI	20,8
CF	EUA622CFNBI	26,0
CS	EUA622CSNBI	27,7
OO	EUA622OONBI	26,0
II	EUA622IINBI	26,0
IS	EUA622ISNBI	27,7
RS	EUA622RSNBI	26,0
SR	EUA622SRNBI	27,7
OS	EUA622OSNBI	27,7

Kusasi



RECESSED BODY
CORPO INCASSO
PARTIE ENCASTRÉ
IUA002CCXN_1 8,8

PACKAGING

L: 530 mm
D: 145 mm
H: 90 mm

4,16 kg



VERTICAL | VERTICALE | VERTICAL

PLATE AND HANDLES TRIMKIT
KIT PIASTRA E MANIGLIE
KIT PLAQUE ET POIGNÉE

CC	EUA612CCNKU	17,3
SS	EUA612SSNKU	21,6
NP	EUA612NPNKU	20,8

HORIZONTAL | ORIZZONTALE | HORIZONTAL

PLATE AND HANDLES TRIMKIT
KIT PIASTRA E MANIGLIE
KIT PLAQUE ET POIGNÉE

CC	EUA622CCNKU	17,3
SS	EUA622SSNKU	21,6
NP	EUA622NPNKU	20,8



Wow



RECESSED BODY
CORPO INCASSO
PARTIE ENCASTRÉ
IUA002CCXN_1 8,8

PACKAGING

L: 530 mm
D: 145 mm
H: 90 mm

4,16 kg

VERTICAL | VERTICALE | VERTICAL

PLATE AND HANDLES TRIMKIT
KIT PIASTRA E MANIGLIE
KIT PLAQUE ET POIGNÉE

CC	EUA612CCNWO	17,3
SS	EUA612SSNWO	21,6
BO	EUA612BONWO	20,8
NP	EUA612NPNWO	20,8
OO	EUA612OONWO	26,0

HORIZONTAL | ORIZZONTALE | HORIZONTAL

PLATE AND HANDLES TRIMKIT
KIT PIASTRA E MANIGLIE
KIT PLAQUE ET POIGNÉE

CC	EUA622CCNWO	17,3
SS	EUA622SSNWO	21,6
BO	EUA622BONWO	20,8
NP	EUA622NPNWO	20,8
OO	EUA622OONWO	26,0

Industria



RECESSED BODY
CORPO INCASSO
PARTIE ENCASTRÉ
IUA002CCXN_1 8,8

PACKAGING

L: 530 mm
D: 145 mm
H: 90 mm

4,16 kg

VERTICAL | VERTICALE | VERTICAL

PLATE AND HANDLES TRIMKIT
KIT PIASTRA E MANIGLIE
KIT PLAQUE ET POIGNÉE

CC	EUA612CCNID1	17,3
SS	EUA612SSNID1	21,6
NP	EUA612NPNID1	20,8
CF	EUA612CFNID1	26,0
CS	EUA612CSNID1	27,7
OO	EUA612OONID1	26,0
II	EUA612IINID1	26,0
IS	EUA612ISNID1	27,7
RS	EUA612RSNID1	26,0
SR	EUA612SRNID1	27,7
OS	EUA612OSNID1	27,7
ON	EUA612ONNID1	17,3

HORIZONTAL | ORIZZONTALE | HORIZONTAL

PLATE AND HANDLES TRIMKIT
KIT PIASTRA E MANIGLIE
KIT PLAQUE ET POIGNÉE

CC	EUA622CCNID1	17,3
SS	EUA622SSNID1	21,6
NP	EUA622NPNID1	20,8
CF	EUA622CFNID1	26,0
CS	EUA622CSNID1	27,7
OO	EUA622OONID1	26,0
II	EUA622IINID1	26,0
IS	EUA622ISNID1	27,7
RS	EUA622RSNID1	26,0
SR	EUA622SRNID1	27,7
OS	EUA622OSNID1	27,7
ON	EUA622ONNID1	17,3

Bold



RECESSED BODY
CORPO INCASSO
PARTIE ENCASTRÉ
IUA002CCXN_1 8,8

PACKAGING

L: 530 mm
D: 145 mm
H: 90 mm

4,16 kg

VERTICAL | VERTICALE | VERTICAL

PLATE AND HANDLES TRIMKIT
KIT PIASTRA E MANIGLIE
KIT PLAQUE ET POIGNÉE

CC	EUA612CCNB1	18,3
SS	EUA612SSNB1	22,9
NP	EUA612NPNB1	22,0
CF	EUA612CFNB1	27,5
CS	EUA612CSNB1	29,3
OO	EUA612OONB1	27,5
II	EUA612IINB1	27,5
IS	EUA612ISNB1	29,3
RS	EUA612RSNB1	27,5
SR	EUA612SRNB1	29,3
OS	EUA612OSNB1	29,3
ON	EUA612ONNB1	18,3

HORIZONTAL | ORIZZONTALE | HORIZONTAL

PLATE AND HANDLES TRIMKIT
KIT PIASTRA E MANIGLIE
KIT PLAQUE ET POIGNÉE

CC	EUA622CCNB1	18,3
SS	EUA622SSNB1	22,9
NP	EUA622NPNB1	22,0
CF	EUA622CFNB1	27,5
CS	EUA622CSNB1	29,3
OO	EUA622OONB1	27,5
II	EUA622IINB1	27,5
IS	EUA622ISNB1	29,3
RS	EUA622RSNB1	27,5
SR	EUA622SRNB1	29,3
OS	EUA622OSNB1	29,3
ON	EUA622ONNB1	18,3

Birkin



RECESSED BODY
CORPO INCASSO
PARTIE ENCASTRÉ
IUA002CCXN_1 8,8

PACKAGING

L: 530 mm
D: 145 mm
H: 90 mm

4,16 kg

VERTICAL | VERTICALE | VERTICAL

PLATE AND HANDLES TRIMKIT
KIT PIASTRA E MANIGLIE
KIT PLAQUE ET POIGNÉE

CC	EUA612CCNBR3	22,3
SS	EUA612SSNBR3	27,9
RS	EUA612RSNBR3	33,5
OS	EUA612OSNBR3	35,7
PL	EUA612PLNBR3	35,7

HORIZONTAL | ORIZZONTALE | HORIZONTAL

PLATE AND HANDLES TRIMKIT
KIT PIASTRA E MANIGLIE
KIT PLAQUE ET POIGNÉE

CC	EUA622CCNBR3	22,3
SS	EUA622SSNBR3	27,9
RS	EUA622RSNBR3	33,5
OS	EUA622OSNBR3	35,7
PL	EUA622PLNBR3	35,7

Marmo



RECESSED BODY
CORPO INCASSO
PARTIE ENCASTRÉ
IUA002CCXN_1 8,8

PACKAGING

L: 530 mm
D: 145 mm
H: 90 mm

4,24 kg

MARBLE

White Carrara

Black Marquina

VERTICAL | VERTICALE | VERTICAL

PLATE AND HANDLES TRIMKIT
KIT PIASTRA E MANIGLIE
KIT PLAQUE ET POIGNÉE

CC	EUA612CCNMR1	EUA612CCNMR2	20,7
SS	EUA612SSNMR1	EUA612SSNMR2	25,9
BO	EUA612BONMR1	EUA612BONMR2	24,9
NP	EUA612NPNMR1	EUA612NPNMR2	24,9
CF	EUA612CFNMR1	EUA612CFNMR2	31,1
CS	EUA612CSNMR1	EUA612CSNMR2	33,2
OO	EUA612OONMR1	EUA612OONMR2	31,1
II	EUA612IINMR1	EUA612IINMR2	31,1
IS	EUA612ISNMR1	EUA612ISNMR2	33,2
RS	EUA612RSNMR1	EUA612RSNMR2	31,1
SR	EUA612SRNMR1	EUA612SRNMR2	33,2
OS	EUA612OSNMR1	EUA612OSNMR2	33,2
ON	EUA612ONNMR1	EUA612PLNMR2	20,7
PL	EUA612PLNMR1	EUA612PLNMR2	33,2

HORIZONTAL | ORIZZONTALE | HORIZONTAL

PLATE AND HANDLES TRIMKIT
KIT PIASTRA E MANIGLIE
KIT PLAQUE ET POIGNÉE

CC	EUA622CCNMR1	EUA622CCNMR2	20,7
SS	EUA622SSNMR1	EUA622SSNMR2	25,9
BO	EUA622BONMR1	EUA622BONMR2	24,9
NP	EUA622NPNMR1	EUA622NPNMR2	24,9
CF	EUA622CFNMR1	EUA622CFNMR2	31,1
CS	EUA622CSNMR1	EUA622CSNMR2	33,2
OO	EUA622OONMR1	EUA622OONMR2	31,1
II	EUA622IINMR1	EUA622IINMR2	31,1
IS	EUA622ISNMR1	EUA622ISNMR2	33,2
RS	EUA622RSNMR1	EUA622RSNMR2	31,1
SR	EUA622SRNMR1	EUA622SRNMR2	33,2
OS	EUA622OSNMR1	EUA622OSNMR2	33,2
ON	EUA622ONNMR1	EUA622PLNMR2	20,7
PL	EUA622PLNMR1	EUA622PLNMR2	33,2

Aqua

Rubacuori



RECESSED BODY
CORPO INCASSO
PARTIE ENCASTRÉ
IUA002CCXN_1 8,8

PACKAGING

L: 530 mm
D: 145 mm
H: 90 mm

4,16 kg



VERTICAL | VERTICALE | VERTICAL

PLATE AND HANDLES TRIMKIT
KIT PIASTRA E MANIGLIE
KIT PLAQUE ET POIGNÉE

CC	EUA611CCNRU	17,3
SS	EUA611SSNRU	21,6
BO	EUA611BONRU	20,8
NP	EUA611NPNRU	20,8
CF	EUA611CFNRU	26,0
CS	EUA611CSNRU	27,7
OO	EUA611OONRU	26,0
II	EUA611IINRU	26,0
IS	EUA611ISNRU	27,7
RS	EUA611RSNRU	26,0
SR	EUA611SRNRU	27,7
OS	EUA611OSNRU	27,7

HORIZONTAL | ORIZZONTALE | HORIZONTAL

PLATE AND HANDLES TRIMKIT
KIT PIASTRA E MANIGLIE
KIT PLAQUE ET POIGNÉE

CC	EUA621CCNRU	17,3
SS	EUA621SSNRU	21,6
BO	EUA621BONRU	20,8
NP	EUA621NPNRU	20,8
CF	EUA621CFNRU	26,0
CS	EUA621CSNRU	27,7
OO	EUA621OONRU	26,0
II	EUA621IINRU	26,0
IS	EUA621ISNRU	27,7
RS	EUA621RSNRU	26,0
SR	EUA621SRNRU	27,7
OS	EUA621OSNRU	27,7

Hey joe!



RECESSED BODY
CORPO INCASSO
PARTIE ENCASTRÉ
IUA002CCXN_1 8,8

PACKAGING

L: 530 mm
D: 145 mm
H: 90 mm

4,16 kg



VERTICAL | VERTICALE | VERTICAL

PLATE AND HANDLES TRIMKIT
KIT PIASTRA E MANIGLIE
KIT PLAQUE ET POIGNÉE

CC	EUA611CCNHJ	17,3
SS	EUA611SSNHJ	21,6
BO	EUA611BONHJ	20,8
NP	EUA611NPNHJ	20,8
CF	EUA611CFNHJ	26,0
CS	EUA611CSNHJ	27,7
OO	EUA611OONHJ	26,0
II	EUA611IINHJ	26,0
IS	EUA611ISNHJ	27,7
RS	EUA611RSNHJ	26,0
SR	EUA611SRNHJ	27,7
OS	EUA611OSNHJ	27,7

HORIZONTAL | ORIZZONTALE | HORIZONTAL

PLATE AND HANDLES TRIMKIT
KIT PIASTRA E MANIGLIE
KIT PLAQUE ET POIGNÉE

CC	EUA621CCNHJ	17,3
SS	EUA621SSNHJ	21,6
BO	EUA621BONHJ	20,8
NP	EUA621NPNHJ	20,8
CF	EUA621CFNHJ	26,0
CS	EUA621CSNHJ	27,7
OO	EUA621OONHJ	26,0
II	EUA621IINHJ	26,0
IS	EUA621ISNHJ	27,7
RS	EUA621RSNHJ	26,0
SR	EUA621SRNHJ	27,7
OS	EUA621OSNHJ	27,7

Belmondo



RECESSED BODY
CORPO INCASSO
PARTIE ENCASTRÉ
IUA002CCXN_1 8,8

PACKAGING

L: 530 mm
D: 145 mm
H: 90 mm

4,16 kg



VERTICAL | VERTICALE | VERTICAL

PLATE AND HANDLES TRIMKIT
KIT PIASTRA E MANIGLIE
KIT PLAQUE ET POIGNÉE

CC	EUA611CCNBT	17,3
OO	EUA611OONBT	26,0
II	EUA611IINBT	26,0
RS	EUA611RSNBT	26,0
PL	EUA611PLNBT	27,7

HORIZONTAL | ORIZZONTALE | HORIZONTAL

PLATE AND HANDLES TRIMKIT
KIT PIASTRA E MANIGLIE
KIT PLAQUE ET POIGNÉE

CC	EUA621CCNBT	17,3
OO	EUA621OONBT	26,0
II	EUA621IINBT	26,0
RS	EUA621RSNBT	26,0
PL	EUA621PLNBT	27,7

Kusasi



RECESSED BODY
CORPO INCASSO
PARTIE ENCASTRÉ
IUA002CCXN_1 8,8

PACKAGING

L: 530 mm
D: 145 mm
H: 90 mm

4,16 kg



VERTICAL | VERTICALE | VERTICAL

PLATE AND HANDLES TRIMKIT
KIT PIASTRA E MANIGLIE
KIT PLAQUE ET POIGNÉE

CC	EUA611CCNKU	17,3
SS	EUA611SSNKU	21,6
NP	EUA611NPNKU	20,8

HORIZONTAL | ORIZZONTALE | HORIZONTAL

PLATE AND HANDLES TRIMKIT
KIT PIASTRA E MANIGLIE
KIT PLAQUE ET POIGNÉE

CC	EUA621CCNKU	17,3
SS	EUA621SSNKU	21,6
NP	EUA621NPNKU	20,8

Wow



RECESSED BODY
CORPO INCASSO
PARTIE ENCASTRÉ
IUA002CCXN_1 8,8

PACKAGING

L: 530 mm
D: 145 mm
H: 90 mm

4,16 kg



VERTICAL | VERTICALE | VERTICAL

PLATE AND HANDLES TRIMKIT
KIT PIASTRA E MANIGLIE
KIT PLAQUE ET POIGNÉE

CC	EUA611CCNWO	17,3
SS	EUA611SSNWO	21,6
BO	EUA611BONWO	20,8
NP	EUA611NPNWO	20,8
OO	EUA611OONWO	26,0

HORIZONTAL | ORIZZONTALE | HORIZONTAL

PLATE AND HANDLES TRIMKIT
KIT PIASTRA E MANIGLIE
KIT PLAQUE ET POIGNÉE

CC	EUA621CCNWO	17,3
SS	EUA621SSNWO	21,6
BO	EUA621BONWO	20,8
NP	EUA621NPNWO	20,8
OO	EUA621OONWO	26,0

Industria



RECESSED BODY
CORPO INCASSO
PARTIE ENCASTRÉ
IUA002CCXN_1 8,8

PACKAGING

L: 530 mm
D: 145 mm
H: 90 mm

4,16 kg

VERTICAL | VERTICALE | VERTICAL

PLATE AND HANDLES TRIMKIT
KIT PIASTRA E MANIGLIE
KIT PLAQUE ET POIGNÉE

CC	EUA611CCNID1	17,3
SS	EUA611SSNID1	21,6
NP	EUA611NPNID1	20,8
CF	EUA611CFNID1	26,0
CS	EUA611CSNID1	27,7
OO	EUA611OONID1	26,0
II	EUA611IINID1	26,0
IS	EUA611ISNID1	27,7
RS	EUA611RSNID1	26,0
SR	EUA611SRNID1	27,7
OS	EUA611OSNID1	27,7
ON	EUA611ONNID1	17,3

HORIZONTAL | ORIZZONTALE | HORIZONTAL

PLATE AND HANDLES TRIMKIT
KIT PIASTRA E MANIGLIE
KIT PLAQUE ET POIGNÉE

CC	EUA621CCNID1	17,3
SS	EUA621SSNID1	21,6
NP	EUA621NPNID1	20,8
CF	EUA621CFNID1	26,0
CS	EUA621CSNID1	27,7
OO	EUA621OONID1	26,0
II	EUA621IINID1	26,0
IS	EUA621ISNID1	27,7
RS	EUA621RSNID1	26,0
SR	EUA621SRNID1	27,7
OS	EUA621OSNID1	27,7
ON	EUA621ONNID1	17,3

Marmo



RECESSED BODY
CORPO INCASSO
PARTIE ENCASTRÉ
IUA002CCXN_1 8,8

PACKAGING

L: 530 mm
D: 145 mm
H: 90 mm

4,24 kg

MARBLE

White Carrara

Black Marquina

VERTICAL | VERTICALE | VERTICAL

PLATE AND HANDLES TRIMKIT
KIT PIASTRA E MANIGLIE
KIT PLAQUE ET POIGNÉE

CC	EUA611CCNMR1	EUA611CCNMR2	20,7
SS	EUA611SSNMR1	EUA611SSNMR2	25,9
BO	EUA611BONMR1	EUA611BONMR2	24,9
NP	EUA611NPNMR1	EUA611NPNMR2	24,9
CF	EUA611CFNMR1	EUA611CFNMR2	31,1
CS	EUA611CSNMR1	EUA611CSNMR2	33,2
OO	EUA611OONMR1	EUA611OONMR2	31,1
II	EUA611IINMR1	EUA611IINMR2	31,1
IS	EUA611ISNMR1	EUA611ISNMR2	33,2
RS	EUA611RSNMR1	EUA611RSNMR2	31,1
SR	EUA611SRNMR1	EUA611SRNMR2	33,2
OS	EUA611OSNMR1	EUA611OSNMR2	33,2
ON	EUA611ONNMR1	EUA611PLNMR2	20,7
PL	EUA611PLNMR1	EUA611PLNMR2	33,2

HORIZONTAL | ORIZZONTALE | HORIZONTAL

PLATE AND HANDLES TRIMKIT
KIT PIASTRA E MANIGLIE
KIT PLAQUE ET POIGNÉE

CC	EUA621CCNMR1	EUA621CCNMR2	20,7
SS	EUA621SSNMR1	EUA621SSNMR2	25,9
BO	EUA621BONMR1	EUA621BONMR2	24,9
NP	EUA621NPNMR1	EUA621NPNMR2	24,9
CF	EUA621CFNMR1	EUA621CFNMR2	31,1
CS	EUA621CSNMR1	EUA621CSNMR2	33,2
OO	EUA621OONMR1	EUA621OONMR2	31,1
II	EUA621IINMR1	EUA621IINMR2	31,1
IS	EUA621ISNMR1	EUA621ISNMR2	33,2
RS	EUA621RSNMR1	EUA621RSNMR2	31,1
SR	EUA621SRNMR1	EUA621SRNMR2	33,2
OS	EUA621OSNMR1	EUA621OSNMR2	33,2
ON	EUA621ONNMR1	EUA621PLNMR2	20,7
PL	EUA621PLNMR1	EUA621PLNMR2	33,2

Hermes



RECESSED BODY
CORPO INCASSO
PARTIE ENCASTRÉ
IUA002CCXN_1 8,8

PACKAGING

L: 530 mm
D: 145 mm
H: 90 mm

4,16 kg

VERTICAL | VERTICALE | VERTICAL

PLATE AND HANDLES TRIMKIT
KIT PIASTRA E MANIGLIE
KIT PLAQUE ET POIGNÉE

CC	EUA615CCNHR	17,4
SS	EUA615SSNHR	21,8
II	EUA615IINHR	26,1
RS	EUA615RSNHR	26,1
OS	EUA615OSNHR	27,9
RR	EUA615RRNHR	24,4
BB	EUA615BBNHR	24,4
PL	EUA615PLNHR	27,9

HORIZONTAL | ORIZZONTALE | HORIZONTAL

PLATE AND HANDLES TRIMKIT
KIT PIASTRA E MANIGLIE
KIT PLAQUE ET POIGNÉE

CC	EUA625CCNHR	17,4
SS	EUA625SSNHR	21,8
II	EUA625IINHR	26,1
RS	EUA625RSNHR	26,1
OS	EUA625OSNHR	27,9
RR	EUA625RRNHR	24,4
BB	EUA625BBNHR	24,4
PL	EUA625PLNHR	27,9

Birkin



RECESSED BODY
CORPO INCASSO
PARTIE ENCASTRÉ
IUA002CCXN_1 8,8

PACKAGING

L: 530 mm
D: 145 mm
H: 90 mm

4,16 kg

VERTICAL | VERTICALE | VERTICAL

PLATE AND HANDLES TRIMKIT
KIT PIASTRA E MANIGLIE
KIT PLAQUE ET POIGNÉE

CC	EUA615CCNBR3	22,3
SS	EUA615SSNBR3	27,9
RS	EUA615RSNBR3	33,5
OS	EUA615OSNBR3	35,7
PL	EUA615PLNBR3	35,7

HORIZONTAL | ORIZZONTALE | HORIZONTAL

PLATE AND HANDLES TRIMKIT
KIT PIASTRA E MANIGLIE
KIT PLAQUE ET POIGNÉE

CC	EUA625CCNBR3	22,3
SS	EUA625SSNBR3	27,9
RS	EUA625RSNBR3	33,5
OS	EUA625OSNBR3	35,7
PL	EUA625PLNBR3	35,7

Aqua

AQUA

Diverter 3 ways

3 vie con deviatore
3 voies avec déviateur

ARTICLE | ARTICOLO | ARTICLE

IUA003CCXN_1

Only the built-in 1½" thermostatic unit of compact size, horizontal / vertical installation
Solo parte incasso termostatico 1/2 " ingombro ridotto, installazione orizzontale / verticale.
Seulement partie encastré du thermostatique 1/2" économie d'espace, installation horizontale / vertical.

CODE / COEFFICIENT | CODICE / COEFFICIENTE | CODE / COEFFICIENT

9,4

TECHNICAL DATA

Minimum dynamic pressure 0,5 bar
Maximum operational pressure 5 bar
Recommended operational pressure da 1 a 5 bar
Maximum hot water temperature 80°C

GENERAL FEATURES

Installation depth from 80 mm to 90 mm.
The intakes are fitted with G1/2" female G3/4" male, threaded connection, the outlets only G1/2"F (1, 2 or 3 way).
The temperature regulator lever is pre-set at 38°C.
Use of a pressure reducer is recommended if pressures in the system exceed 5 bar.

DATI TECNICI

Pressione dinamica minima 0,5 bar
Pressione di esercizio massima 5 bar
Pressione di utilizzo raccomandata da 1 a 5 bar
Temperatura massima acqua calda 80°C

CARATTERISTICHE GENERALI

Profondità di installazione da 80 mm a 90 mm.
Le entrate vengono fornite con filetto G1/2" femmina G3/4" maschio, le uscite solo G1/2"F (1, 2 o 3 vie).
La maniglia di regolazione temperatura, viene pre-settata a 38°C.
Si raccomanda l'utilizzo di un riduttore di pressione, se all'interno dell'impianto, si hanno pressioni superiori a 5 bar.

DONNÉES TECHNIQUES

Pression dynamique minimum 0,5 bar
Pression de service maximale de 5 bar
Pression d'utilisation conseillé de 1 à 5 bar
Température maximale de l'eau chaude 80 ° C

CARACTERISTIQUES GENERALES

Profondeur de montage de 80 mm à 90 mm.
Les entrées sont fournis avec filetage G1/2" femelle G3/4" mâle, les sorties G1/2"F (1,2,ou 3 voies).
La poignée de réglage de la température, est pré-réglée à 38 ° C Si à l'intérieur du système vous avez des pressions supérieures à 5 bars, il est recommandé l'utilisation d'un réducteur de pression.

Built-in part - Parte incasso - Corps encastré

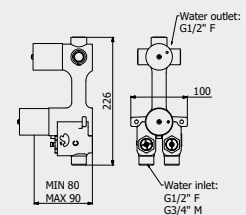

Plate and handles - Parte esterna - Plaque et poignée

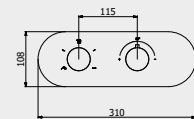
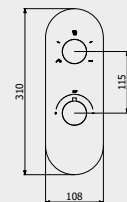

Plate and handles - Parte esterna - Plaque et poignée



PACKAGING

L: 240 mm D: 115 mm H: 160 mm 3,4 kg

ORIENTATION | ORIENTAZIONE | ORIENTATION

2 ways to installation: horizontal or vertical
2 modalità di installazione: verticale o orizzontale
2 modalités de installation: vertical ou horizontal.

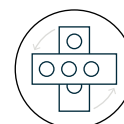

FOR ALL MODELS
PER TUTTI I MODELLI
POUR TOUS LES MODÈLES





A Mixed water outlet
Uscita acqua miscelata
Sortie eau mélangé



B Mixed water outlet
Uscita acqua miscelata
Sortie eau mélangé



C Mixed water outlet
Uscita acqua miscelata
Sortie eau mélangé



H Hot water
Acqua calda
Eau chaude



C Cold water
Acqua fredda
Eau froide

Aqua

PORTATE | WATER FLOW | DÉBIT D'EAU

0.2 BAR	0.5 BAR	1 BAR	2 BAR	3 BAR	4 BAR	5 BAR
10,7 l/m	18 l/m	26 l/m	37 l/m	45 l/m	51 l/m	56 l/m

Hey Joe!



RECESSED BODY
CORPO INCASSO
PARTIE ENCASTRÉ
IUA003CCXN_1 9,4

PACKAGING

L: 530 mm
D: 145 mm
H: 90 mm

4,16 kg



VERTICAL | VERTICALE | VERTICAL

PLATE AND HANDLES TRIMKIT
KIT PIASTRA E MANIGLIE
KIT PLAQUE ET POIGNÉE

CC	EUA712CCNHJ	17,3
SS	EUA712SSNHJ	21,6
BO	EUA712BONHJ	20,8
NP	EUA712NPNHJ	20,8
CF	EUA712CFNHJ	26,0
CS	EUA712CSNHJ	27,7
OO	EUA712OONHJ	26,0
II	EUA712IINHJ	26,0
IS	EUA712ISNHJ	27,7
RS	EUA712RSNHJ	26,0
SR	EUA712SRNHJ	27,7
OS	EUA712OSNHJ	27,7

HORIZONTAL | ORIZZONTALE | HORIZONTAL

PLATE AND HANDLES TRIMKIT
KIT PIASTRA E MANIGLIE
KIT PLAQUE ET POIGNÉE

CC	EUA722CCNHJ	17,3
SS	EUA722SSNHJ	21,6
BO	EUA722BONHJ	20,8
NP	EUA722NPNHJ	20,8
CF	EUA722CFNHJ	26,0
CS	EUA722CSNHJ	27,7
OO	EUA722OONHJ	26,0
II	EUA722IINHJ	26,0
IS	EUA722ISNHJ	27,7
RS	EUA722RSNHJ	26,0
SR	EUA722SRNHJ	27,7
OS	EUA722OSNHJ	27,7

Loveme



RECESSED BODY
CORPO INCASSO
PARTIE ENCASTRÉ
IUA003CCXN_1 9,4

PACKAGING

L: 530 mm
D: 145 mm
H: 90 mm

4,16 kg



VERTICAL | VERTICALE | VERTICAL

PLATE AND HANDLES TRIMKIT
KIT PIASTRA E MANIGLIE
KIT PLAQUE ET POIGNÉE

CC	EUA712CCNLM	17,3
SS	EUA712SSNLM	21,6
BO	EUA712BONLM	20,8
NP	EUA712NPNLM	20,8
CS	EUA712CSNLM	27,7
IS	EUA712ISNLM	27,7
SR	EUA712SRNLM	27,7
OS	EUA712OSNLM	27,7
ON	EUA712ONNLM	17,3

HORIZONTAL | ORIZZONTALE | HORIZONTAL

PLATE AND HANDLES TRIMKIT
KIT PIASTRA E MANIGLIE
KIT PLAQUE ET POIGNÉE

CC	EUA722CCNLM	17,3
SS	EUA722SSNLM	21,6
BO	EUA722BONLM	20,8
NP	EUA722NPNLM	20,8
CS	EUA722CSNLM	27,7
IS	EUA722ISNLM	27,7
SR	EUA722SRNLM	27,7
OS	EUA722OSNLM	27,7
ON	EUA722ONNLM	17,3

Belmondo



RECESSED BODY
CORPO INCASSO
PARTIE ENCASTRÉ
IUA003CCXN_1 9,4

PACKAGING

L: 530 mm
D: 145 mm
H: 90 mm

4,16 kg



VERTICAL | VERTICALE | VERTICAL

PLATE AND HANDLES TRIMKIT
KIT PIASTRA E MANIGLIE
KIT PLAQUE ET POIGNÉE

CC	EUA712CCNBT	17,3
OO	EUA712OONBT	26,0
II	EUA712IINBT	26,0
RS	EUA712RSNBT	26,0
PL	EUA712PLNBT	27,7

HORIZONTAL | ORIZZONTALE | HORIZONTAL

PLATE AND HANDLES TRIMKIT
KIT PIASTRA E MANIGLIE
KIT PLAQUE ET POIGNÉE

CC	EUA722CCNBT	17,3
OO	EUA722OONBT	26,0
II	EUA722IINBT	26,0
RS	EUA722RSNBT	26,0
PL	EUA722PLNBT	27,7

Batlò



RECESSED BODY
CORPO INCASSO
PARTIE ENCASTRÉ
IUA003CCXN_1 9,4

PACKAGING

L: 530 mm
D: 145 mm
H: 90 mm

4,16 kg



VERTICAL | VERTICALE | VERTICAL

PLATE AND HANDLES TRIMKIT
KIT PIASTRA E MANIGLIE
KIT PLAQUE ET POIGNÉE

CC	EUA712CCNBI	17,3
SS	EUA712SSNBI	21,6
BO	EUA712BONBI	20,8
NP	EUA712NPNBI	20,8
CF	EUA712CFNBI	26,0
CS	EUA712CSNBI	27,7
OO	EUA712OONBI	26,0
II	EUA712IINBI	26,0
IS	EUA712ISNBI	27,7
RS	EUA712RSNBI	26,0
SR	EUA712SRNBI	27,7
OS	EUA712OSNBI	27,7

HORIZONTAL | ORIZZONTALE | HORIZONTAL

PLATE AND HANDLES TRIMKIT
KIT PIASTRA E MANIGLIE
KIT PLAQUE ET POIGNÉE

CC	EUA722CCNBI	17,3
SS	EUA722SSNBI	21,6
BO	EUA722BONBI	20,8
NP	EUA722NPNBI	20,8
CF	EUA722CFNBI	26,0
CS	EUA722CSNBI	27,7
OO	EUA722OONBI	26,0
II	EUA722IINBI	26,0
IS	EUA722ISNBI	27,7
RS	EUA722RSNBI	26,0
SR	EUA722SRNBI	27,7
OS	EUA722OSNBI	27,7

Kusasi



RECESSED BODY
CORPO INCASSO
PARTIE ENCASTRÉ
IUA003CCXN_1 9,4

PACKAGING

L: 530 mm
D: 145 mm
H: 90 mm

4,16 kg



VERTICAL | VERTICALE | VERTICAL

PLATE AND HANDLES TRIMKIT
KIT PIASTRA E MANIGLIE
KIT PLAQUE ET POIGNÉE

CC	EUA712CCNKU	17,3
SS	EUA712SSNKU	21,6
NP	EUA712NPNKU	20,8

HORIZONTAL | ORIZZONTALE | HORIZONTAL

PLATE AND HANDLES TRIMKIT
KIT PIASTRA E MANIGLIE
KIT PLAQUE ET POIGNÉE

CC	EUA722CCNKU	17,3
SS	EUA722SSNKU	21,6
NP	EUA722NPNKU	20,8

Wow

RECESSED BODY
CORPO INCASSO
PARTIE ENCASTRÉ

IUA003CCXN_1 9,4



PACKAGING

 L: 530 mm
D: 145 mm
H: 90 mm

 4,16 kg

VERTICAL | VERTICALE | VERTICAL

PLATE AND HANDLES TRIMKIT
KIT PIASTRA E MANIGLIE
KIT PLAQUE ET POIGNÉE

	CC	EUA712CCNWO	17,3
	SS	EUA712SSNWO	21,6
	BO	EUA712BONWO	20,8
	NP	EUA712NPNWO	20,8
	OO	EUA712OONWO	26,0

HORIZONTAL | ORIZZONTALE | HORIZONTAL

PLATE AND HANDLES TRIMKIT
KIT PIASTRA E MANIGLIE
KIT PLAQUE ET POIGNÉE

	CC	EUA722CCNWO	17,3
	SS	EUA722SSNWO	21,6
	BO	EUA722BONWO	20,8
	NP	EUA722NPNWO	20,8
	OO	EUA722OONWO	26,0

Industria

RECESSED BODY
CORPO INCASSO
PARTIE ENCASTRÉ

IUA003CCXN_1 9,4















PACKAGING

 L: 530 mm
D: 145 mm
H: 90 mm

 4,16 kg













VERTICAL | VERTICALE | VERTICAL

PLATE AND HANDLES TRIMKIT
KIT PIASTRA E MANIGLIE
KIT PLAQUE ET POIGNÉE

	CC	EUA712CCNID1	17,3
	SS	EUA712SSNID1	21,6
	NP	EUA712NPNID1	20,8
	CF	EUA712CFNID1	26,0
	CS	EUA712CSNID1	27,7
	OO	EUA712OONID1	26,0
	II	EUA712IINID1	26,0
	IS	EUA712ISNID1	27,7
	RS	EUA712RSNID1	26,0
	SR	EUA712SRNID1	27,7
	OS	EUA712OSNID1	27,7
	ON	EUA712ONNID1	17,3

HORIZONTAL | ORIZZONTALE | HORIZONTAL

PLATE AND HANDLES TRIMKIT
KIT PIASTRA E MANIGLIE
KIT PLAQUE ET POIGNÉE

	CC	EUA722CCNID1	17,3
	SS	EUA722SSNID1	21,6
	NP	EUA722NPNID1	20,8
	CF	EUA722CFNID1	26,0
	CS	EUA722CSNID1	27,7
	OO	EUA722OONID1	26,0
	II	EUA722IINID1	26,0
	IS	EUA722ISNID1	27,7
	RS	EUA722RSNID1	26,0
	SR	EUA722SRNID1	27,7
	OS	EUA722OSNID1	27,7
	ON	EUA722ONNID1	17,3

Bold

RECESSED BODY
CORPO INCASSO
PARTIE ENCASTRÉ

IUA003CCXN_1 9,4















PACKAGING

 L: 530 mm
D: 145 mm
H: 90 mm

 4,16 kg













VERTICAL | VERTICALE | VERTICAL

PLATE AND HANDLES TRIMKIT
KIT PIASTRA E MANIGLIE
KIT PLAQUE ET POIGNÉE

	CC	EUA712CCNB1	18,3
	SS	EUA712SSNB1	22,9
	NP	EUA712NPNB1	22,0
	CF	EUA712CFNB1	27,5
	CS	EUA712CSNB1	29,3
	OO	EUA712OONB1	27,5
	II	EUA712IINB1	27,5
	IS	EUA712ISNB1	29,3
	RS	EUA712RSNB1	27,5
	SR	EUA712SRNB1	29,3
	OS	EUA712OSNB1	29,3
	ON	EUA712ONNB1	18,3

HORIZONTAL | ORIZZONTALE | HORIZONTAL

PLATE AND HANDLES TRIMKIT
KIT PIASTRA E MANIGLIE
KIT PLAQUE ET POIGNÉE

	CC	EUA722CCNB1	18,3
	SS	EUA722SSNB1	22,9
	NP	EUA722NPNB1	22,0
	CF	EUA722CFNB1	27,5
	CS	EUA722CSNB1	29,3
	OO	EUA722OONB1	27,5
	II	EUA722IINB1	27,5
	IS	EUA722ISNB1	29,3
	RS	EUA722RSNB1	27,5
	SR	EUA722SRNB1	29,3
	OS	EUA722OSNB1	29,3
	ON	EUA722ONNB1	18,3

Birkin

RECESSED BODY
CORPO INCASSO
PARTIE ENCASTRÉ

IUA003CCXN_1 9,4



PACKAGING

 L: 530 mm
D: 145 mm
H: 90 mm

 4,16 kg

VERTICAL | VERTICALE | VERTICAL

PLATE AND HANDLES TRIMKIT
KIT PIASTRA E MANIGLIE
KIT PLAQUE ET POIGNÉE

	CC	EUA712CCNBR3	22,3
	SS	EUA712SSNBR3	27,9
	RS	EUA712RSNBR3	33,5
	OS	EUA712OSNBR3	35,7
	PL	EUA712PLNBR3	35,7

HORIZONTAL | ORIZZONTALE | HORIZONTAL

PLATE AND HANDLES TRIMKIT
KIT PIASTRA E MANIGLIE
KIT PLAQUE ET POIGNÉE

	CC	EUA722CCNBR3	22,3
	SS	EUA722SSNBR3	27,9
	RS	EUA722RSNBR3	33,5
	OS	EUA722OSNBR3	35,7
	PL	EUA722PLNBR3	35,7

Marmo

RECESSED BODY
CORPO INCASSO
PARTIE ENCASTRÉ

IUA003CCXN_1 9,4



PACKAGING

 L: 530 mm
D: 145 mm
H: 90 mm

 4,24 kg















MARBLE

 White Carrara

 Black Marquina















VERTICAL | VERTICALE | VERTICAL

PLATE AND HANDLES TRIMKIT
KIT PIASTRA E MANIGLIE
KIT PLAQUE ET POIGNÉE

	CC	EUA712CCNMR1	EUA712CCNMR2	20,7
	SS	EUA712SSNMR1	EUA712SSNMR2	25,9
	BO	EUA712BONMR1	EUA712BONMR2	24,9
	NP	EUA712NPNMR1	EUA712NPNMR2	24,9
	CF	EUA712CFNMR1	EUA712CFNMR2	31,1
	CS	EUA712CSNMR1	EUA712CSNMR2	33,2
	OO	EUA712OONMR1	EUA712OONMR2	31,1
	II	EUA712IINMR1	EUA712IINMR2	31,1
	IS	EUA712ISNMR1	EUA712ISNMR2	33,2
	RS	EUA712RSNMR1	EUA712RSNMR2	31,1
	SR	EUA712SRNMR1	EUA712SRNMR2	33,2
	OS	EUA712OSNMR1	EUA712OSNMR2	33,2
	ON	EUA712ONNMR1	EUA712PLNMR2	20,7
	PL	EUA712PLNMR1	EUA712PLNMR2	33,2

HORIZONTAL | ORIZZONTALE | HORIZONTAL

PLATE AND HANDLES TRIMKIT
KIT PIASTRA E MANIGLIE
KIT PLAQUE ET POIGNÉE

	CC	EUA722CCNMR1	EUA722CCNMR2	20,7
	SS	EUA722SSNMR1	EUA722SSNMR2	25,9
	BO	EUA722BONMR1	EUA722BONMR2	24,9
	NP	EUA722NPNMR1	EUA722NPNMR2	24,9
	CF	EUA722CFNMR1	EUA722CFNMR2	31,1
	CS	EUA722CSNMR1	EUA722CSNMR2	33,2
	OO	EUA722OONMR1	EUA722OONMR2	31,1
	II	EUA722IINMR1	EUA722IINMR2	31,1
	IS	EUA722ISNMR1	EUA722ISNMR2	33,2
	RS	EUA722RSNMR1	EUA722RSNMR2	31,1
	SR	EUA722SRNMR1	EUA722SRNMR2	33,2
	OS	EUA722OSNMR1	EUA722OSNMR2	33,2
	ON	EUA722ONNMR1	EUA722PLNMR2	20,7
	PL	EUA722PLNMR1	EUA722PLNMR2	33,2

Aqua

Rubacuori



RECESSED BODY
CORPO INCASSO
PARTIE ENCASTRÉ
IUA003CCXN_1 9,4

PACKAGING

L: 530 mm
D: 145 mm
H: 90 mm

4,16 kg



VERTICAL | VERTICALE | VERTICAL

PLATE AND HANDLES TRIMKIT
KIT PIASTRÀ E MANIGLIE
KIT PLAQUE ET POIGNÉE

CC	EUA711CCNRU	17,3
SS	EUA711SSNRU	21,6
BO	EUA711BONRU	20,8
NP	EUA711NPNRU	20,8
CF	EUA711CFNRU	26,0
CS	EUA711CSNRU	27,7
OO	EUA711OONRU	26,0
II	EUA711IINRU	26,0
IS	EUA711ISNRU	27,7
RS	EUA711RSNRU	26,0
SR	EUA711SRNRU	27,7
OS	EUA711OSNRU	27,7

HORIZONTAL | ORIZZONTALE | HORIZONTAL

PLATE AND HANDLES TRIMKIT
KIT PIASTRÀ E MANIGLIE
KIT PLAQUE ET POIGNÉE

CC	EUA721CCNRU	17,3
SS	EUA721SSNRU	21,6
BO	EUA721BONRU	20,8
NP	EUA721NPNRU	20,8
CF	EUA721CFNRU	26,0
CS	EUA721CSNRU	27,7
OO	EUA721OONRU	26,0
II	EUA721IINRU	26,0
IS	EUA721ISNRU	27,7
RS	EUA721RSNRU	26,0
SR	EUA721SRNRU	27,7
OS	EUA721OSNRU	27,7

Hey joe!



RECESSED BODY
CORPO INCASSO
PARTIE ENCASTRÉ
IUA003CCXN_1 9,4

PACKAGING

L: 530 mm
D: 145 mm
H: 90 mm

4,16 kg



VERTICAL | VERTICALE | VERTICAL

PLATE AND HANDLES TRIMKIT
KIT PIASTRÀ E MANIGLIE
KIT PLAQUE ET POIGNÉE

CC	EUA711CCNHJ	17,3
SS	EUA711SSNHJ	21,6
BO	EUA711BONHJ	20,8
NP	EUA711NPNHJ	20,8
CF	EUA711CFNHJ	26,0
CS	EUA711CSNHJ	27,7
OO	EUA711OONHJ	26,0
II	EUA711IINHJ	26,0
IS	EUA711ISNHJ	27,7
RS	EUA711RSNHJ	26,0
SR	EUA711SRNHJ	27,7
OS	EUA711OSNHJ	27,7

HORIZONTAL | ORIZZONTALE | HORIZONTAL

PLATE AND HANDLES TRIMKIT
KIT PIASTRÀ E MANIGLIE
KIT PLAQUE ET POIGNÉE

CC	EUA721CCNHJ	17,3
SS	EUA721SSNHJ	21,6
BO	EUA721BONHJ	20,8
NP	EUA721NPNHJ	20,8
CF	EUA721CFNHJ	26,0
CS	EUA721CSNHJ	27,7
OO	EUA721OONHJ	26,0
II	EUA721IINHJ	26,0
IS	EUA721ISNHJ	27,7
RS	EUA721RSNHJ	26,0
SR	EUA721SRNHJ	27,7
OS	EUA721OSNHJ	27,7

Belmondo



RECESSED BODY
CORPO INCASSO
PARTIE ENCASTRÉ
IUA003CCXN_1 9,4

PACKAGING

L: 530 mm
D: 145 mm
H: 90 mm

4,16 kg



VERTICAL | VERTICALE | VERTICAL

PLATE AND HANDLES TRIMKIT
KIT PIASTRÀ E MANIGLIE
KIT PLAQUE ET POIGNÉE

CC	EUA711CCNBT	17,3
OO	EUA711OONBT	26,0
II	EUA711IINBT	26,0
RS	EUA711RSNBT	26,0
PL	EUA711PLNBT	27,7

HORIZONTAL | ORIZZONTALE | HORIZONTAL

PLATE AND HANDLES TRIMKIT
KIT PIASTRÀ E MANIGLIE
KIT PLAQUE ET POIGNÉE

CC	EUA721CCNBT	17,3
OO	EUA721OONBT	26,0
II	EUA721IINBT	26,0
RS	EUA721RSNBT	26,0
PL	EUA721PLNBT	27,7

Kusasi



RECESSED BODY
CORPO INCASSO
PARTIE ENCASTRÉ
IUA003CCXN_1 9,4

PACKAGING

L: 530 mm
D: 145 mm
H: 90 mm

4,16 kg



VERTICAL | VERTICALE | VERTICAL

PLATE AND HANDLES TRIMKIT
KIT PIASTRÀ E MANIGLIE
KIT PLAQUE ET POIGNÉE

CC	EUA711CCNKU	17,3
SS	EUA711SSNKU	21,6
NP	EUA711NPNKU	20,8

HORIZONTAL | ORIZZONTALE | HORIZONTAL

PLATE AND HANDLES TRIMKIT
KIT PIASTRÀ E MANIGLIE
KIT PLAQUE ET POIGNÉE

CC	EUA721CCNKU	17,3
SS	EUA721SSNKU	21,6
NP	EUA721NPNKU	20,8

Wow



RECESSED BODY
CORPO INCASSO
PARTIE ENCASTRÉ
IUA003CCXN_1 9,4

PACKAGING

L: 530 mm
D: 145 mm
H: 90 mm

4,16 kg



VERTICAL | VERTICALE | VERTICAL

PLATE AND HANDLES TRIMKIT
KIT PIASTRÀ E MANIGLIE
KIT PLAQUE ET POIGNÉE

CC	EUA711CCNWO	17,3
SS	EUA711SSNWO	21,6
BO	EUA711BONWO	20,8
NP	EUA711NPNWO	20,8
OO	EUA711OONWO	26,0

HORIZONTAL | ORIZZONTALE | HORIZONTAL

PLATE AND HANDLES TRIMKIT
KIT PIASTRÀ E MANIGLIE
KIT PLAQUE ET POIGNÉE

CC	EUA721CCNWO	17,3
SS	EUA721SSNWO	21,6
BO	EUA721BONWO	20,8
NP	EUA721NPNWO	20,8
OO	EUA721OONWO	26,0

Industria



RECESSED BODY
CORPO INCASSO
PARTIE ENCASTRÉ
IUA003CCXN_1 9,4

PACKAGING

L: 530 mm
D: 145 mm
H: 90 mm

4,16 kg

VERTICAL | VERTICALE | VERTICAL

PLATE AND HANDLES TRIMKIT
KIT PIASTRA E MANIGLIE
KIT PLAQUE ET POIGNÉE

CC	EUA711CCNID1	17,3
SS	EUA711SSNID1	21,6
NP	EUA711NPNID1	20,8
CF	EUA711CFNID1	26,0
CS	EUA711CSNID1	27,7
OO	EUA711OONID1	26,0
II	EUA711IINID1	26,0
IS	EUA711ISNID1	27,7
RS	EUA711RSNID1	26,0
SR	EUA711SRNID1	27,7
OS	EUA711OSNID1	27,7
ON	EUA711ONNID1	17,3

HORIZONTAL | ORIZZONTALE | HORIZONTAL

PLATE AND HANDLES TRIMKIT
KIT PIASTRA E MANIGLIE
KIT PLAQUE ET POIGNÉE

CC	EUA721CCNID1	17,3
SS	EUA721SSNID1	21,6
NP	EUA721NPNID1	20,8
CF	EUA721CFNID1	26,0
CS	EUA721CSNID1	27,7
OO	EUA721OONID1	26,0
II	EUA721IINID1	26,0
IS	EUA721ISNID1	27,7
RS	EUA721RSNID1	26,0
SR	EUA721SRNID1	27,7
OS	EUA721OSNID1	27,7
ON	EUA721ONNID1	17,3

Marmo



RECESSED BODY
CORPO INCASSO
PARTIE ENCASTRÉ
IUA003CCXN_1 9,4

PACKAGING

L: 530 mm
D: 145 mm
H: 90 mm

4,24 kg

MARBLE

White Carrara

Black Marquina

VERTICAL | VERTICALE | VERTICAL

PLATE AND HANDLES TRIMKIT
KIT PIASTRA E MANIGLIE
KIT PLAQUE ET POIGNÉE

CC	EUA711CCNMR1	EUA711CCNMR2	20,7
SS	EUA711SSNMR1	EUA711SSNMR2	25,9
BO	EUA711BONMR1	EUA711BONMR2	24,9
NP	EUA711NPNMR1	EUA711NPNMR2	24,9
CF	EUA711CFNMR1	EUA711CFNMR2	31,1
CS	EUA711CSNMR1	EUA711CSNMR2	33,2
OO	EUA711OONMR1	EUA711OONMR2	31,1
II	EUA711IINMR1	EUA711IINMR2	31,1
IS	EUA711ISNMR1	EUA711ISNMR2	33,2
RS	EUA711RSNMR1	EUA711RSNMR2	31,1
SR	EUA711SRNMR1	EUA711SRNMR2	33,2
OS	EUA711OSNMR1	EUA711OSNMR2	33,2
ON	EUA711ONNMR1	EUA711PLNMR2	20,7
PL	EUA711PLNMR1	EUA711PLNMR2	33,2

HORIZONTAL | ORIZZONTALE | HORIZONTAL

PLATE AND HANDLES TRIMKIT
KIT PIASTRA E MANIGLIE
KIT PLAQUE ET POIGNÉE

CC	EUA721CCNMR1	EUA721CCNMR2	20,7
SS	EUA721SSNMR1	EUA721SSNMR2	25,9
BO	EUA721BONMR1	EUA721BONMR2	24,9
NP	EUA721NPNMR1	EUA721NPNMR2	24,9
CF	EUA721CFNMR1	EUA721CFNMR2	31,1
CS	EUA721CSNMR1	EUA721CSNMR2	33,2
OO	EUA721OONMR1	EUA721OONMR2	31,1
II	EUA721IINMR1	EUA721IINMR2	31,1
IS	EUA721ISNMR1	EUA721ISNMR2	33,2
RS	EUA721RSNMR1	EUA721RSNMR2	31,1
SR	EUA721SRNMR1	EUA721SRNMR2	33,2
OS	EUA721OSNMR1	EUA721OSNMR2	33,2
ON	EUA721ONNMR1	EUA721PLNMR2	20,7
PL	EUA721PLNMR1	EUA721PLNMR2	33,2

Hermes



RECESSED BODY
CORPO INCASSO
PARTIE ENCASTRÉ
IUA003CCXN_1 9,4

PACKAGING

L: 530 mm
D: 145 mm
H: 90 mm

4,16 kg

VERTICAL | VERTICALE | VERTICAL

PLATE AND HANDLES TRIMKIT
KIT PIASTRA E MANIGLIE
KIT PLAQUE ET POIGNÉE

CC	EUA715CCNHR	17,4
SS	EUA715SSNHR	21,8
RS	EUA715RSNHR	26,1
OS	EUA715OSNHR	27,9
RR	EUA715RRNHR	24,4
BB	EUA715BBNHR	24,4
PL	EUA715PLNHR	27,9

HORIZONTAL | ORIZZONTALE | HORIZONTAL

PLATE AND HANDLES TRIMKIT
KIT PIASTRA E MANIGLIE
KIT PLAQUE ET POIGNÉE

CC	EUA725CCNHR	17,4
SS	EUA725SSNHR	21,8
RS	EUA725RSNHR	26,1
OS	EUA725OSNHR	27,9
RR	EUA725RRNHR	24,4
BB	EUA725BBNHR	24,4
PL	EUA725PLNHR	27,9

Birkin



RECESSED BODY
CORPO INCASSO
PARTIE ENCASTRÉ
IUA003CCXN_1 9,4

PACKAGING

L: 530 mm
D: 145 mm
H: 90 mm

4,16 kg

VERTICAL | VERTICALE | VERTICAL

PLATE AND HANDLES TRIMKIT
KIT PIASTRA E MANIGLIE
KIT PLAQUE ET POIGNÉE

CC	EUA715CCNBR3	22,3
SS	EUA715SSNBR3	27,9
RS	EUA715RSNBR3	33,5
OS	EUA715OSNBR3	35,7
PL	EUA715PLNBR3	35,7

HORIZONTAL | ORIZZONTALE | HORIZONTAL

PLATE AND HANDLES TRIMKIT
KIT PIASTRA E MANIGLIE
KIT PLAQUE ET POIGNÉE

CC	EUA725CCNBR3	22,3
SS	EUA725SSNBR3	27,9
RS	EUA725RSNBR3	33,5
OS	EUA725OSNBR3	35,7
PL	EUA725PLNBR3	35,7

Aqua



Interactive PDF, you can view the collection directly by clicking on it.
PDF interattivo, per visualizzare direttamente la collezione basta cliccarci sopra.
PDF interactif, vous pouvez voir la collection directement en cliquant dessus.



AQUARIVA
P. 580



AQUABEAT
P. 592



ONAIR 2.0
P. 606



DROP
P. 612



**MONAMOUR
SHOWER HEADS
+ ARMS**
P. 618

SHOWER

HEADS

SOFFIONI
TÊTE DE DOUCHE

Shower
head

AQUARIVA

Made to shine your wellness experience.

Progettato per far risplendere la tua esperienza wellness.
Créée pour faire briller votre expérience de bien-être.

A shining surface, pure and linear geometric shapes: the AQUARIVA collection, through its minimal design, achieves an eternal creation whose aesthetic perfection will seduce your eye and mind. The components are manufactured in a high-quality raw material, finely worked in our laboratories. The three refined showerheads, available in twelve finishes and two sizes, provide a flexible but constant aesthetic elegance, in order to express freely your inimitable personality.

Una superficie lucente, forme geometriche pure e lineari: la collezione AQUARIVA perviene, tramite il suo design minimale, a una creazione eterna la cui perfezione estetica saprà affascinare occhio e mente. Le componenti sono realizzate a partire da una materia prima di alta qualità, finemente lavorata nei nostri laboratori. I tre ricercati soffioni doccia, disponibili in dodici finiture e in due dimensioni, garantiscono un'eleganza estetica duttile ma costante, per dare sfogo alla tua inimitabile personalità.

Une surface brillante, des formes géométriques pures et linéaires: la collection AQUARIVA parvient, par son design minimal, à une création éternelle dont la perfection esthétique saura fasciner les yeux et l'esprit. Les composants sont fabriqués à partir d'une matière première de haute qualité, finement travaillée dans nos laboratoires. Les trois sophistiqués pommes de douche, disponibles en douze finitions et en deux tailles, garantissent une élégance esthétique à la fois souple et constante, pour donner libre cours à votre inimitable personnalité.



LEAD FREE



ZINC FREE



RGB LIGHT









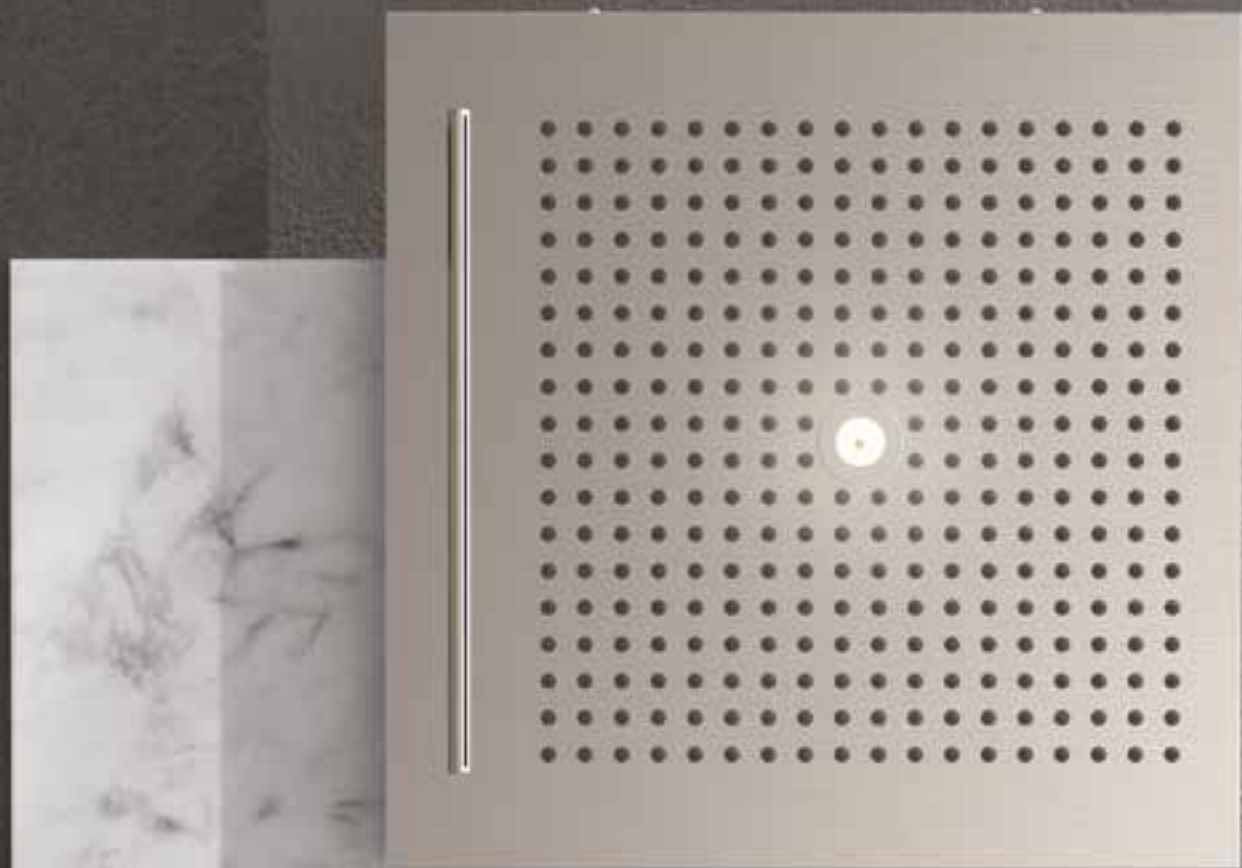





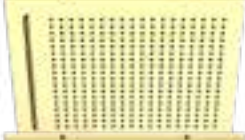

DESIGN
ANDREA + DAVIDE BREGOLI

Aquariva



CC		CHROME CHROMO CHROME
SS		BRUSHED NICKEL NICKEL SPAZZOLATO NICKEL BROSSÉ
BO		MATT WHITE BIANCO OPACO BLANC MAT
NP		MATT BLACK NERO OPACO NOIR MAT
CF		BLACK CHROME BLACK CHROME CHROME NOIR
CS		BRUSHED BLACK CHROME CROMO NERO SPAZZOLATO CHROME NOIR BROSSÉ
OO		GOLD 22K ORO 22K OR 22K
OS		BRUSHED GOLD 22K ORO SPAZZOLATO 22K OR BROSSÉ 22K
II		PALE GOLD 18K ORO INGLESE 18K OR PALE 18K
IS		BRUSHED PALE GOLD 18K ORO INGLESE SPAZZOLATO 18K OR PALE BROSSÉ 18K
RS		ROSE GOLD 18K ORO ROSA 18K OR ROSE 18K
SR		BRUSHED ROSE GOLD 18K ORO ROSA SPAZZOLATO 18K OR ROSE BROSSÉ 18K

Aquariva

AQUARIVA knows your every wish and will fulfil it through a range of four different functions, from the nebulized jet to chromotherapy, that merge and intersect to recreate the harmonic and relaxing atmosphere of an authentic home Spa completely at your service.

AQUARIVA conosce ogni tuo desiderio, e saprà realizzarlo attraverso una gamma di 4 funzioni differenti, dal getto nebulizzato alla cromoterapia, che convergono e si compenetrano per ricreare l'ambiente armonioso e rilassante di un'autentica Spa casalinga a tuo completo servizio.

AQUARIVA connaît tous vos désirs et va les réaliser à travers quatre fonctions différentes, allant du jet nébulisé à la chromothérapie, qui convergent et se mêlent pour recréer l'atmosphère harmonieuse et relaxante d'un authentique Spa à domicile, à votre entière disposition.

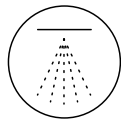

Nebulization

Nebulizzazione
Pulvérisation

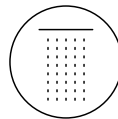

Rain jet

Getto a pioggia
Jet de pluie



Waterfall

Cascata
Chute d'eau

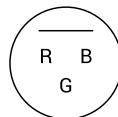

Chromo therapy

Cromoterapia
Chromothérapie





Chromotherapy: the colours of wellness

Cromoterapia: il benessere a colori

Chromothérapie: le bien-être en couleurs

GREEN_

It affects the nervous system, inducing harmony and calm, and helping to forge a pensive attitude.

Agisce sul sistema nervoso, inducendo all'armonia e alla calma, e contribuendo a forgiare un atteggiamento riflessivo.

Il agit sur le système nerveux, induisant à l'harmonie et à la calme et favorisant une attitude réflexive.

BLUE_

It acts on the nervous system, with calming and invigorating effects, against stress, anxiety and insomnia disorders.

Agisce sul sistema nervoso, con effetti calmanti e corroboranti, contro lo stress e i disturbi d'ansia e d'insonnia.

Il agit sur le système nerveux avec un effet apaisant et vivifiant, contre le stress, l'anxiété et les troubles de l'insomnie.

RED_

It stimulates adrenaline and fights melancholy by transmitting heat, strengthening vital energy and passion.

Stimola l'adrenalina e combatte la malinconia, trasmettendo calore, rafforzando l'energia vitale e la passione.

Il stimule l'adrénaline et combat la mélancolie en transmettant la chaleur, renforçant l'énergie vitale et la passion.

YELLOW_

It promotes concentration and good mood, thanks to its revitalizing effects inciting to movement and transformation.

Favorisce la concentrazione e il buonumore, grazie ai suoi effetti rivitalizzanti che incitano al movimento e alla trasformazione.

Il favorise la concentration et la bonne humeur, grâce à ses effets revitalisants qui incitent au mouvement et à la transformation.

Light control by remote control.

Controllo della luce tramite telecomando.

Contrôle de la lumière par télécommande.







ARTICLE | ARTICOLO | ARTICLE

AV360



Semi built-in showered with rain and waterfall.

Soffione doccia da semi incasso con getto a pioggia e cascata.

Pomme de douche semi-encastrée avec jet de pluie et chute d'eau.

CODE / COEFFICIENT | CODICE / COEFFICIENTE | CODE / COEFFICIENT

CC	AV360CC	59,3
SS	AV360SS	79,3
BO	AV360BO	79,3
NP	AV360NP	79,3
CF	AV360CF	84,3
CS	AV360CS	84,3
OO	AV360OO	84,3
OS	AV360OS	84,3
II	AV360II	84,3
IS	AV360IS	84,3
RS	AV360RS	84,3
SR	AV360SR	84,3

PACKAGING

L: 455 mm
D: 455 mm
H: 155 mm

9 kg

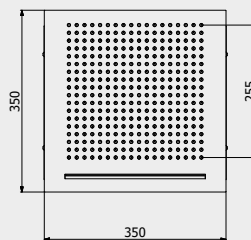

PORTATE | WATER FLOW | DÉBIT D'EAU

	1 BAR	2 BAR	3 BAR
Head shower Soffione Tête de douche	23,3 l/m	33 l/m	40,9 l/m
Waterfall Cascata Chute d'eau	25,2 l/m	36,2 l/m	45 l/m

ARTICLE | ARTICOLO | ARTICLE

AV370



Semi built-in showered with rain, waterfall and chromotherapy.

Soffione doccia da semi incasso con getto a pioggia, cascata e cromoterapia.

Pomme de douche semi-encastrée avec jet de pluie, chute d'eau et chromothérapie.

CODE / COEFFICIENT | CODICE / COEFFICIENTE | CODE / COEFFICIENT

CC	AV370CC	110,0
SS	AV370SS	130,0
BO	AV370BO	130,0
NP	AV370NP	130,0
CF	AV370CF	135,0
CS	AV370CS	135,0
OO	AV370OO	135,0
OS	AV370OS	135,0
II	AV370II	135,0
IS	AV370IS	135,0
RS	AV370RS	135,0
SR	AV370SR	135,0

PACKAGING

L: 455 mm
D: 455 mm
H: 155 mm

9 kg

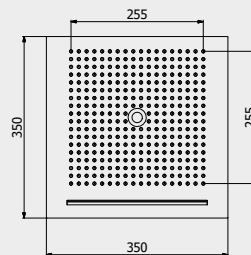

PORTATE | WATER FLOW | DÉBIT D'EAU

	1 BAR	2 BAR	3 BAR
Head shower Soffione Tête de douche	23,3 l/m	33 l/m	40,9 l/m
Waterfall Cascata Chute d'eau	25,2 l/m	36,2 l/m	45 l/m

ARTICLE | ARTICOLO | ARTICLE

AV630



Semi built-in showered with rain, waterfall, nebulization and chromotherapy.

Soffione doccia da semi incasso con getto a pioggia, cascata, nebulizzazione e cromoterapia.

Pomme de douche semi-encastrée avec jet de pluie, chute d'eau, vaporisation et chromothérapie.

CODE / COEFFICIENT | CODICE / COEFFICIENTE | CODE / COEFFICIENT

CC	AV630CC	240,0
SS	AV630SS	265,0
BO	AV630BO	265,0
NP	AV630NP	265,0
CF	AV630CF	275,0
CS	AV630CS	275,0
OO	AV630OO	275,0
OS	AV630OS	275,0
II	AV630II	275,0
IS	AV630S	275,0
RS	AV630RS	275,0
SR	AV630SR	275,0

PACKAGING

L: 705 mm
D: 705 mm
155: 98 mm

17 kg

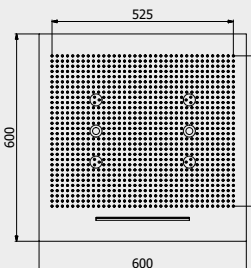

PORTATE | WATER FLOW | DÉBIT D'EAU

	1 BAR	2 BAR	3 BAR
Head shower Soffione Tête de douche	21,8 l/m	32,8 l/m	40,7 l/m
Waterfall Cascata Chute d'eau	25,2 l/m	36,2 l/m	45 l/m
Nebulisation Nebulizzazione Nébulisation	10,2 l/m	15 l/m	18 l/m

Aquariva

Examples of possible combinations

Esempi di combinazioni possibili
Exemples de combinaisons possibles

ARTICLE | ARTICOLO | ARTICLE

AV360



COMBINATION | COMBINAZIONI | COMBINAISON



p. 510



Two ways wall shower mixer model 310.
Miscelatore doccia a parete con deviatore due vie modello 310.
Mitigeur douche mural deux voies avec inverseur référence 310.

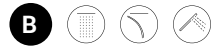

p. 511



Three ways wall shower mixer model 314.
Miscelatore doccia a parete con deviatore tre vie modello 314.
Mitigeur douche mural trois voies avec inverseur référence 314.



p. 577



AQUA thermostatic valve control 3 ways diverter.
AQUA valvola termostatica a 3 vie con deviatore.
AQUA valve thermostatique à 3 voies avec déviateur.

+



p. 654

Duplex round - round Model SH022.
Duplex Tondo - Tondo Modello SH022.
Duplex rond prise d'eau, douche rond Model SH022.

ARTICLE | ARTICOLO | ARTICLE

AV370



COMBINATION | COMBINAZIONI | COMBINAISON



p. 569



AQUA thermostatic valve control 2 ways diverter.
AQUA valvola termostatica a 2 vie con deviatore.
AQUA valve thermostatique à 2 voies avec déviateur.



p. 554



AQUA thermostatic valve control 2 independent ways.
AQUA valvola termostatica a 2 vie indipendenti.
AQUA valve thermostatique à 2 voies indépendante.

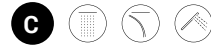

p. 550



AQUA thermostatic valve control 3 independent ways.
AQUA valvola termostatica a 3 vie indipendenti.
AQUA valve thermostatique à 3 voies indépendante.

+



p. 654

Duplex round - round Model SH022
Duplex Tondo - Tondo Modello SH022
Duplex rond prise d'eau, douche rond Model SH022

ARTICLE | ARTICOLO | ARTICLE

AV630



COMBINATION | COMBINAZIONI | COMBINAISON

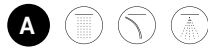

p. 510

One way wall shower mixer model 312.
Miscelatore doccia a parete una via modello 312.
Mitigeur douche mural une voie référence 312.



p. 556

AQUA thermostatic valve control 4 independent ways.
AQUA valvola termostatica a 4 vie indipendenti.
AQUA valve thermostatique à 4 voies indépendante.

+



p. 654

Duplex round - round Model SH022.
Duplex Tondo - Tondo Modello SH022.
Duplex rond prise d'eau, douche rond Model SH022.



p. 564

AQUA thermostatic valve control 5 independent ways.
AQUA valvola termostatica a 5 vie indipendenti.
AQUA valve thermostatique à 5 voies indépendante.

+



p. 654

Duplex round - round Model SH022.
Duplex Tondo - Tondo Modello SH022
Duplex rond prise d'eau, douche rond Model SH022.

+



p. 660

Round body - jet Model SH031.
Getto laterale tondo Modello SH031.
Body-Jet rond référence SH031.

Aquariva

AQUABEAT

Many functions, only one goal, your relax.

Tante funzioni, un obiettivo, il tuo relax.

De nombreuses fonction, un seul but, votre relaxation.

AQUABEAT collection aims to recreate the same well being and relaxing feelings of a professional Spa, through a wide selection of products adaptable to every desire. Choosing from a range of four showerheads, different in size and function, Aquabeat guarantees a wide set of services combinations, from chromotherapy and nebulization to the double waterfall and the cervical massage, cuddling you with a high quality personalized product.

La collezione AQUABEAT si propone di ricreare le stesse sensazioni di benessere e relax di una Spa professionale, attraverso un vasto assortimento di prodotti adattabili a ogni desiderio. Scegliendo tra una gamma di quattro soffioni doccia, variabili per dimensioni e funzioni, Aquabeat permetterà di variare la combinazione dei servizi, scegliendo tra cromoterapia, nebulizzazione, doppia cascata e massaggio cervicale, per una coccola personalizzata di alta qualità.

La collection AQUABEAT vise à recréer les mêmes sensations de bien-être et de détente d'un Spa professionnel, grâce à un grand assortiment de produits adaptables à tous les goûts. En choisissant parmi une gamme de quatre pommes de douche, variables par taille et fonction, Aquabeat vous permet de varier la combinaison de services, en triant la chromothérapie, la nébulisation, la double cascade ou le massage cervical, pour un câlin personnalisé de haute qualité.



LEAD FREE



ZINC FREE



RGB LIGHT



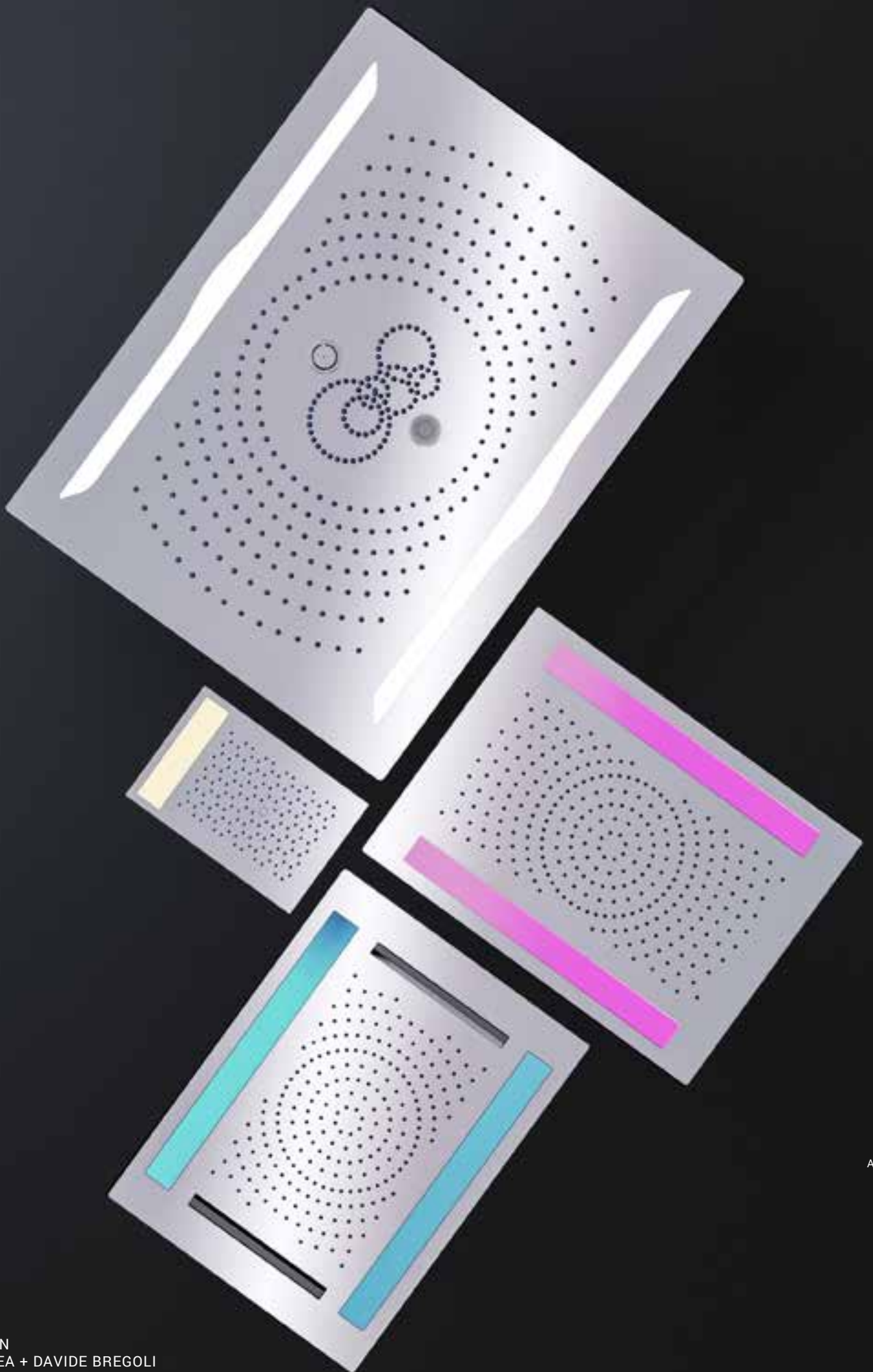

Aquabeat

DESIGN
ANDREA + DAVIDE BREGOLI

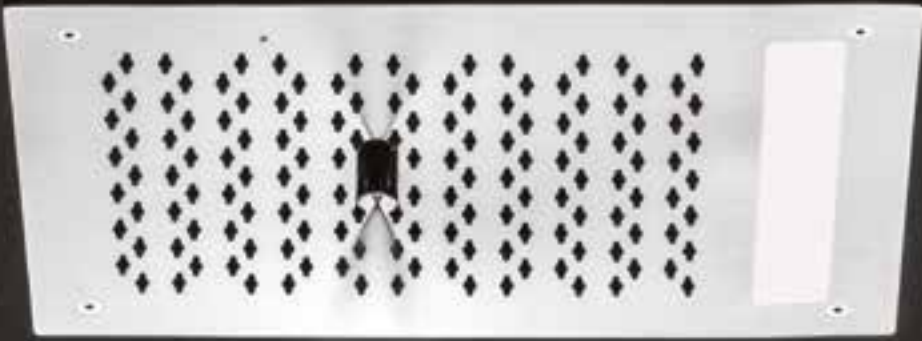



↑ AB200CC

→ AB400CC

← AB100CC



Aquabeat

AL_ Anti-limestone food safe silicone membrane

Membrana in silicone alimentare anti calcare.
Membrane en silicone alimentaire anticalcaire

RGB_ Chromotherapy thanks to integrated LED lighting

Illuminazione LED cromoterapeutica integrata
Éclairage LED chromothérapeutique intégré

56_{mm} Maximum depth required for fixing

Profondità massima necessaria per il fissaggio
Profondeur maximale de fixation requise

120_{mm} Up to 120 mm diagonal at the top of the showerhead range

Fino a 120 mm di estensione diagonale del soffione
Jusqu'à 120mm d'extension diagonale du pomme de douche

18_{L/m} For a minimum constant optimal operation

Funzionamento minimo costante ottimale
Profondeur maximale de fixation requise

1_{Bar} Minimum flow rate supported, even with flow rates of 1 Bar the water is fluent and doesn't lose its effectiveness.

Portata minima sopportata, anche con portate di 1 Bar l'acqua è fluente e non perde di efficacia.
Débit minimum toléré, même avec des débits de 1 bar, l'eau s'écoule et ne perd pas son efficacité.









Aquabeat

Aquabeat offers some of the most requested functions for a complete support to your body and mind well-being. All the showerheads are equipped with integrated LED lights for chromotherapy with remote control and are associated with different water jets, from nebulization and double waterfall up to cervical massage.

Aquabeat offre una vasta gamma di funzioni tra le più richieste del settore, per un supporto completo al benessere del corpo e della mente. Tutti i soffioni sono forniti di luci LED integrate per la cromoterapia, gestibili in remoto e associate a getti d'acqua differenti, dalla nebulizzazione alla doppia cascata, fino al massaggio cervicale.

Aquabeat propose une large gamme de fonctions parmi les plus demandées du secteur, afin d'offrir un soutien complet au bien-être du corps et de l'esprit. Les pommes de douche sont tous équipés d'éclairage LED intégré pour la chromothérapie, gérable à distance et associé aux différents jets d'eau, allant du jet nébulisé et du massage cervical jusqu'à la double cascade.

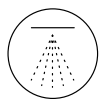

Nebulization

Nebulizzazione
Pulvérisation



Small rain

Soffione stretto
Tête de douche petite



Neck massage

Massaggio cervicale
Massage de la nuque



Rain jet

Getto a pioggia
Jet de pluie



Double waterfall

Cascata doppia
Chute d'eau double



Chromo therapy

Cromoterapia
Chromothérapie



Light control by remote control.
Controllo della luce tramite telecomando.
Contrôle de la lumière par télécommande.

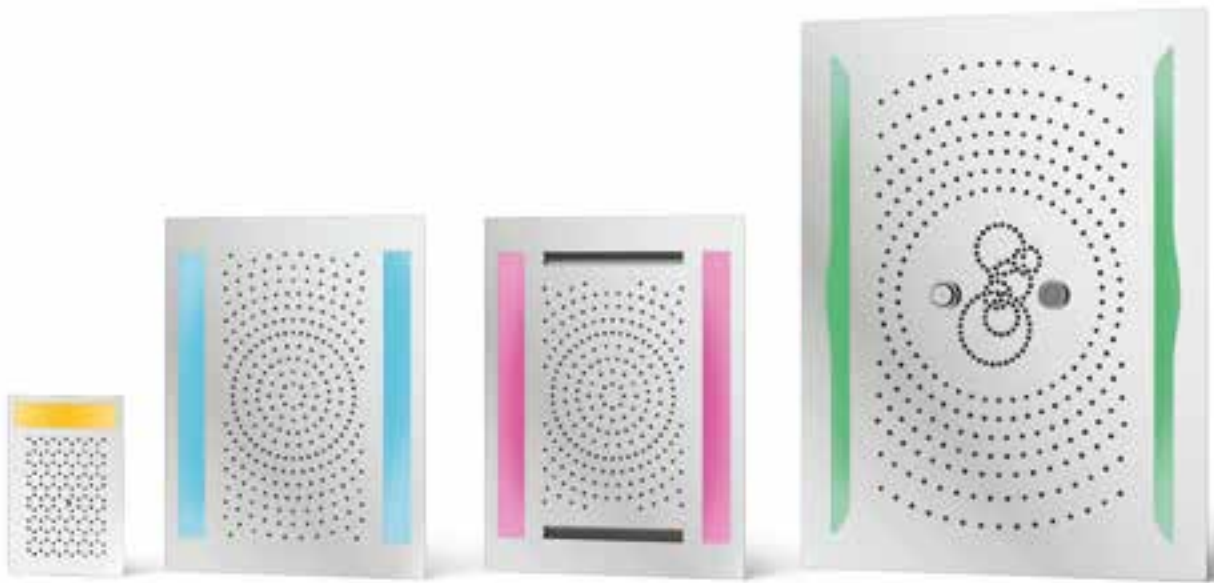

AQUABEAT SMALL

AB 100
300 x 200 x h45 mm



AQUABEAT MEDIUM

AB 200
600 x 450 x h56 mm



AQUABEAT MEDIUM +

AB 400
600 x 450 x h56 mm



AQUABEAT LARGE

AB 800
1000 x 700 x h56 mm



Aquabeat

ARTICLE | ARTICOLO | ARTICLE

AB100CC

Ceiling or wall mountable built in showerhead/body jet with rain, nebulization and chromotherapy.

Soffione doccia a incasso installabile a soffitto o a parete con getto a pioggia, nebulizzazione e cromoterapia.

Pomme de douche encastré pouvant être installé à plafond ou à mur, avec jet de pluie, nébulisation et chromothérapie

CODE / COEFFICIENT | CODICE / COEFFICIENTE | CODE / COEFFICIENT

CC AB100CC 27,5



DIMENSIONS | DIMENSIONI | DIMENSIONS

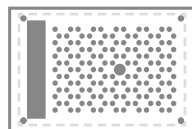

300 x 200 x h45

Shower head | Soffione | Douche

280 x 180 x h46

Size ceiling hole | Foro a soffitto | Dimension trou au plafond

PACKAGING

L: 455 mm D: 310 mm H: 75 mm 4,6 kg

FLOW RATE | PORTATE | DEBIT

3 BAR

Recessed mixer with diverter
model 310
Miscelatore incasso con
deviatore modello 310
Mélangeur encastré avec
déviateur référence 310

SHOWER
DOCCIA
DOUCHE

11 l/m

VAPORIZER
NEBULIZZATORE
PULVERISATION

0,60 l/m

ARTICLE | ARTICOLO | ARTICLE

AB200CC

Ceiling built-in showerhead with rain and chromotherapy.

Soffione doccia a incasso a soffitto con getto a pioggia e cromoterapia.

Pomme de douche encastré à plafond avec jet de pluie et chromothérapie.

CODE / COEFFICIENT | CODICE / COEFFICIENTE | CODE / COEFFICIENT

CC AB200CC 82,3



DIMENSIONS | DIMENSIONI | DIMENSIONS

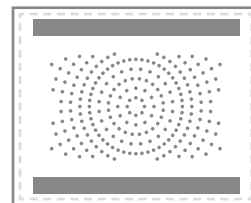

600 x 450 x h56

Shower head | Soffione | Douche

579 x 421 x h56

Size ceiling hole | Foro a soffitto | Dimension trou au plafond

PACKAGING

L: 800 mm D: 520 mm H: 135 mm 14,6 kg

FLOW RATE | PORTATE | DEBIT

3 BAR

Recessed mixer
with diverter
model 312
Miscelatore incasso
con deviatore
modello 312
Mélangeur en-
castré avec déviat-
eur référence 312

Recessed mixer
with three ways
model 312
Miscelatore
incasso 3 uscite
modello 312
Mélangeur enca-
stré trois voies
référence 312

MIXED WATER
ACQUA MISCELATA
EAU MÉLANGE

16,5 l/m

16,5 l/m



ARTICLE | ARTICOLO | ARTICLE

AB400CC

Ceiling built-in showerhead with rain, double waterfall and chromotherapy.

Soffione doccia a incasso a soffitto con getto a pioggia, doppia cascata e cromoterapia.

Pomme de douche encastré à plafond avec jet de pluie, double chute d'eau et chromothérapie.

CODE / COEFFICIENT | CODICE / COEFFICIENTE | CODE / COEFFICIENT

CC AB400CC 92,6



DIMENSIONS | DIMENSIONI | DIMENSIONS

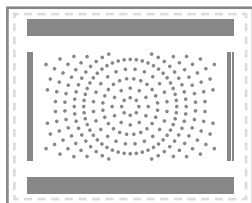

600 x 450 x h56

Shower head | Soffione | Douche

579 x 421 x h56

Size ceiling hole | Foro a soffitto | Dimension trou au plafond

PACKAGING

L: 800 mm D: 520 mm H: 135 mm 14,6 kg

FLOW RATE PORTATE DEBIT				
3 BAR	Direct inlets Ingresso diretto Accès direct	Recessed mixer with diverter model 310 Miscelatore incasso con deviatore modello 310 Mélangeur encastré avec déviateur référence 310	Recessed mixer with three ways model 312 Miscelatore incasso tre uscite modello 312 Mélangeur encastré trois voies référence 312	
	SHOWERHEAD SOFFIONE TETE DE DOUCHE	16,5 l/m	16,5 l/m	20,5 l/m
WATERFALL CASCATA CHUTE D'EAU	20,5 l/m	20,5 l/m	20,5 l/m	

ARTICLE | ARTICOLO | ARTICLE

AB800CC

Ceiling built-in showerhead with rain, lateral water veils, intense rain, aerated, nebulization and chromotherapy.

Soffione doccia a incasso a soffitto con getto a pioggia, veli d'acqua laterali, pioggia intensa, getto aerato, nebulizzazione e cromoterapia.

Pomme de douche encastré à plafond avec jet de pluie, voiles d'eau latérales, pluie intense, jet aéré, nébulisation et chromothérapie.

CODE / COEFFICIENT | CODICE / COEFFICIENTE | CODE / COEFFICIENT

CC AB800CC 139,6



DIMENSIONS | DIMENSIONI | DIMENSIONS

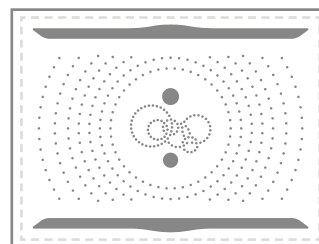

1000 x 700 x h56

Shower head | Soffione | Douche

969 x 673 x h56

Size ceiling hole | Foro a soffitto | Dimension trou au plafond

PACKAGING

L: 1140 mm D: 840 mm H: 150 mm 37,8 kg

FLOW RATE PORTATE DEBIT	
3 BAR	Direct inlets Ingresso diretto Accès direct
OUTSIDE RAIN CORONA ESTERNA CHUTE D'EAU EXTÉRIEURE	15,5 l/m
TOTALE RAIN CORONA TOTALE CHUTE D'EAU TOTALE	16,5 l/m
CENTRAL RAIN CORONA CENTRALE CHUTE D'EAU CENTRALE	15 l/m
NEBULIZER NEBULIZZATORE VAPORISATEUR	0,6 l/m
AERATOR MASSAGGIO CERVICALE MASSAGE AU COU	10 l/m

Aquabeat

Examples of possible combinations

Esempi di combinazioni possibili
Exemples de combinaisons possibles

ARTICLE | ARTICOLO | ARTICLE

AB100CC



COMBINATION | COMBINAZIONI | COMBINAISON



p. 510

Two ways wall shower mixer model 310
Miscelatore doccia a parete con deviatore due vie modello 310
Mitigeur douche mural 2 voies avec inverseur référence 310

ARTICLE | ARTICOLO | ARTICLE

AB200CC



COMBINATION | COMBINAZIONI | COMBINAISON



p. 510

One way wall shower mixer model 300
Miscelatore doccia a parete una via Modello 300
Mitigeur douche mural 1 voie référence 300

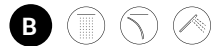

p. 510

Three ways wall shower mixer model 314
Miscelatore doccia a parete con deviatore tre vie modello 314
Mitigeur douche mural 3 voies avec inverseur référence 314



p. 510

Three ways wall shower mixer model 314
Miscelatore doccia a parete con deviatore tre vie modello 314
Mitigeur douche mural 3 voies avec inverseur référence 314



p. 577

+



p. 654

AQUA thermostatic valve control 3 ways diverter.
AQUA valvola termostatica a 3 vie con deviatore.
AQUA vanne thermostatique à 3 voies avec déviateur.

Duplex round - round Model SH022
Duplex Tondo - Tondo Modello SH022
Duplex rond prise d'eau, douche rond Model SH022

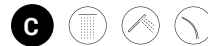

p. 550

+



p. 654

+



p. 227

AQUA thermostatic valve control 3 independent ways.
AQUA valvola termostatica a 3 vie indipendenti.
AQUA vanne thermostatique à 3 voies indépendantes.

Duplex round - round Model SH022
Duplex Tondo - Tondo Modello SH022
Duplex rond prise d'eau, douche rond Model SH022

Built-in wall mounted water-fall spout
Cascata a parete con erogazione esterna
Cascade murale avec bec externe



ARTICLE | ARTICOLO | ARTICLE

AB400CC



COMBINATION | COMBINAZIONI | COMBINAISON



p. 510

Three ways wall shower mixer model 314
Miscelatore doccia a parete con deviatore tre vie modello 314
Mitigeur douche mural 3 voies avec inverseur référence 314

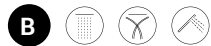

p. 550

AQUA thermostatic valve control 3 independent ways.
AQUA valvola termostatica a 3 vie indipendenti.
AQUA vanne thermostatique à 3 voies indépendantes.



p. 654

Duplex round - round Model SH022
Duplex Tondo - Tondo Modello SH022
Duplex rond prise d'eau, douche rond Model SH022



p. 556

AQUA thermostatic valve control 4 independent ways.
AQUA valvola termostatica a 4 vie indipendenti.
AQUA vanne thermostatique à 4 voies indépendantes.



p. 654

Duplex round - round Model SH022
Duplex Tondo - Tondo Modello SH022
Duplex rond prise d'eau, douche rond Model SH022



p. 660

Round body - jet Model SH031
Getto laterale tondo Modello SH031
Body-Jet rond référence SH031

ARTICLE | ARTICOLO | ARTICLE

AB800CC



COMBINATION | COMBINAZIONI | COMBINAISON



p. 556

Thermostatic valve 4 ways free
Valvola termostatica con 4 vie indipendenti
Valve thermostatique par 4 voies d'arrêt



p. 564

AQUA thermostatic valve control 5 independent ways.
AQUA valvola termostatica a 5 vie indipendenti.
AQUA vanne thermostatique à 5 voies indépendantes.



p. 654

Duplex round - round Model SH022
Duplex Tondo - Tondo Modello SH022
Duplex rond prise d'eau, douche rond Model SH022



p. 564

AQUA thermostatic valve control 5 independent ways.
AQUA valvola termostatica a 5 vie indipendenti.
AQUA vanne thermostatique à 5 voies indépendantes.



p. 227

Built-in wall mounted waterfall spout
Cascata a parete con erogazione esterna
Cascade murale avec bec externe

Aquabeat

ONAIR 2.0

Not an evolution but a different point of view, more subtle.

Non un'evoluzione ma un punto di vista diverso, più sottile.
Pas une evolution mais un point de vue different, plus subtil.

A steel blade stretching out from the wall like an arm, from which a powerful waterfall or the delicate touch of a thin drizzle flow: the ONAIR 2.0 collection offers a multiple jet shower fit to every desire and an innovative design, aesthetically delicate and elegant but technologically advanced, ready to update the traditional concept of shower.

Una lama in acciaio che si protende come un braccio dalla parete, da cui scende una cascata dalla prorompente purezza o il tocco delicato di una pioggerella fine: la collezione ONAIR 2.0 offre un prodotto dal getto differenziato capace di soddisfare ogni desiderio e un design innovativo, esteticamente delicato ed elegante ma tecnologicamente all'avanguardia, pronto ad aggiornare e riformulare il tradizionale concetto di doccia.

Une lame en acier qui se penche par le mur comme un bras, d'où tombe une cascade impétueuse ou une fine bruine délicate: la collection ONAIR 2.0 propose un produit aux jets différenciés capable de satisfaire tous les désirs avec un design innovant, esthétiquement délicat et élégant mais technologiquement avancée, prêt à renouveler et subvertir le concept traditionnel de douche.



LEAD FREE



ZINC FREE







The Airmix wall-mounted showerhead allows water and air to mix, guaranteeing the choice between two easily adjustable jets, the traditional rain showerhead and the hand shower with waterfall jet. The anti-limestone silicone nozzles also prevent any obstruction, providing a strong and constant flow.

Il soffione a parete Airmix permette di miscelare acqua e aria, garantendo la scelta tra due getti facilmente regolabili, il tradizionale soffione a pioggia direzionabile e il doccino comprensivo di getto a cascata. La presenza di ugelli in silicone anticalcare previene inoltre ogni ostruzione, garantendo un flusso forte e costante.

Le pomme de douche mural Airmix, grâce à sa capacité de mélanger eau et air, garantit le choix entre deux jets facilement réglables, le traditionnel pomme de douche au jet de pluie réglable et celui comprenant un jet à cascade. La présence de buses en silicone anticalcaire empêche en outre toute obstruction, garantissant un débit d'eau fort et constant.

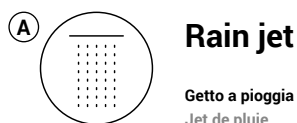





CODE / COEFFICIENT | CODICE / COEFFICIENTE | CODE / COEFFICIENT

CC OA101SS 18,0

PACKAGING

L: 685 mm D: 345 mm H: 168 mm 7,6 kg

FLOW RATE | PORTATA | DÉBIT D'EAU

DIRECT INLETS INGRESSO DIRETTO ENTRÉE DIRECTE			
	1 BAR	2 BAR	3 BAR
Head shower Soffione Tête de douche	15,3 l/m	22,1 l/m	26,1 l/m
Waterfall Cascata Chute d'eau	14,8 l/m	21 l/m	24,3 l/m
RECESSED MIXER WITH DIVERTER MODEL 310 MISCELATORE INCASSO CON DEVIATORE 310 MELANGEUR ENCASTRÉ AVEC DÉVIATEUR RÉFÉRENCE 310			
	1 BAR	2 BAR	3 BAR
Head shower Soffione Tête de douche	7,5 l/m	10,6 l/m	13 l/m
Waterfall Cascata Chute d'eau	6,7 l/m	9,6 l/m	11,8 l/m

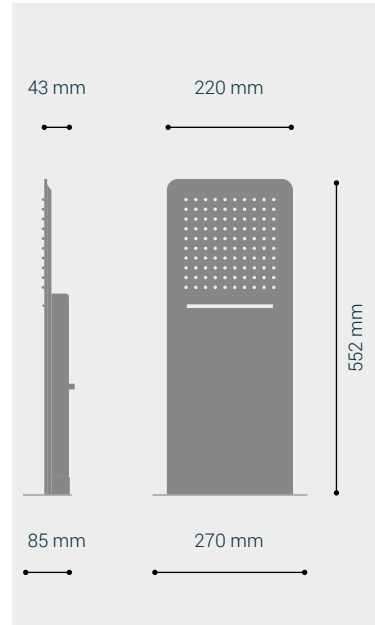

FITTING INSTRUCTIONS | ISTRUZIONI DI MONTAGGIO | INSTRUCTIONS DE MONTAGE

The two 1/2" water connections have to be in line with the wall and their interax have to be 40 mms. The water outlets will be on the left for the showerhead (A) and on the right for the waterfall (B).

Portare le due uscite dell'acqua con dei collegamenti da 1/2" a filo muro e con un interasse tra loro di 35 mm. Rispettivamente gli attacchi sono a sinistra per il soffione (A) e a destra per la cascata (B).

Amener les deux sorties de l'eau avec des connexions de 1/2 à fil du mur et avec une distance entre eux de 35 mm. Respectivement, les attaques sont à gauche pour la tête de douche (A) et à droite pour la chute d'eau (B).

Once the fixing plate is correctly installed on the wall, connect the showerhead to the water connections and installation into the plate.

Una volta fissata a muro la piastra di montaggio collegare il soffione all'impianto idraulico e a sua volta ancorarlo alla piastra.

Une fois fixé la plaque de montage à la paroi, relier la tête de douche à la tuyauterie et à son tour l'ancrer à la plaque.

Height from floor 2000 mm
Altezza consigliata da terra 2000 mm
Hauteur conseillée 2000 mm du sol

910 mm minimum shower base depth
Profondità minima piatto doccia 910 mm
Profondité minimal bac à douche 910 mm

DROP

A true icon of the bathroom.

Icona del design per il bagno.
Icône du design pour la salle de bain.

A true icon of the bathroom design, DROP replicates the features of a drop of water, deformable to touch, guaranteeing a gentle and regular flow. Designed by Giulio Iacchetti, this product has challenged the traditional shower design by innovating its form and material. Thanks to its aesthetic and technological features, DROP is the most suitable choice for an original and incomparable high-quality bathroom.

Icona del design per il bagno, la collezione DROP riproduce le fattezze di una goccia d'acqua deformabile al tatto e garantisce un flusso delicato e uniforme. Progettato da Giulio Iacchetti, questo prodotto ha rimesso in discussione la tradizione del design per docce, innovandone forma e materiale. Per le sue caratteristiche estetiche e tecnologiche, DROP è la scelta più adatta per un bagno d'autore dal carattere inedito e di alta qualità.

Icône du design pour la salle de bain, la collection DROP reproduit la silhouette d'une goutte d'eau, déformable au toucher, et garantit un débit délicat et uniforme. Conçu par Giulio Iacchetti, ce produit a remis en question le traditionnel design de la douche, en innovant sa forme et ses matériaux. En raison de ses caractéristiques esthétiques et technologiques, DROP est le choix le plus convenable pour une salle de bains d'auteur au caractère innovant de haute qualité.



LEAD FREE



ZINC FREE







The DROP showerhead is made of pure anti-limestone silicone and is available in six different colours, a technological and aesthetic innovation that earned it numerous awards and recognitions. DROP is also equipped with a valve that guarantees a water flow never exceeding 10.5 l / m.

Il soffione della collezione DROP è composto da puro silicone anticalcare ed è disponibile in sei colorazioni differenti, un'innovazione tecnologica ed estetica che gli è valsa numerosi premi e riconoscimenti. È inoltre dotato di una valvola di portata che garantisce un flusso d'acqua mai superiore a 10,5 l/m.

Le pomme de douche de la collection DROP est fabriqué en silicone anticalcaire et disponible en six couleurs différentes, une innovation technologique et esthétique qui lui a valu de nombreux prix et distinctions. Il est également doté d'une valve de débit garantissant un débit d'eau toujours inférieur aux 10,5 l / m.



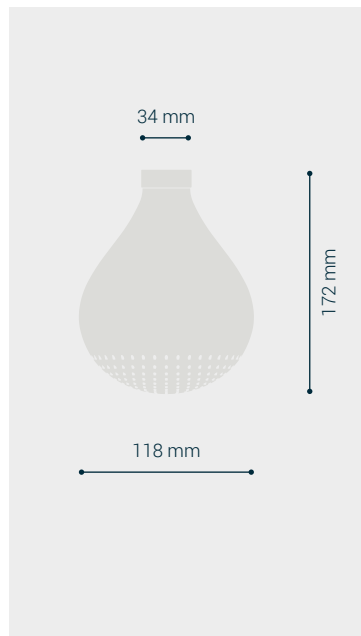
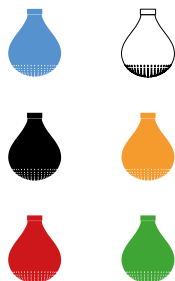

COLOUR COLORE COLOR	CODE CODICE CODE	COEFFICIENT COEFFICIENTE COEFFICIENT
● Blue / Blu	DR001	3,1
○ White / Bianco	DR002	3,1
● Black / Nero	DR003	3,1
● Orange / Arancio	DR004	3,1
● Red / Rosso	DR005	3,1
● Green / Verde	DR006	3,1

PACKAGING

📦 L: 120 mm D: 120 mm H: 165 mm ⚖️ 0,4 kg

APPLICATIONS | APPLICAZIONI | APPLICATIONS

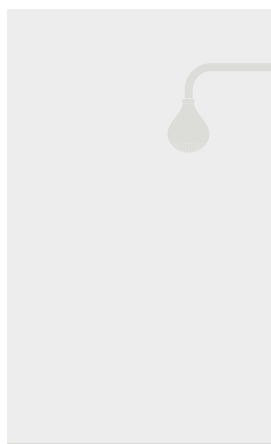

Wall mounted

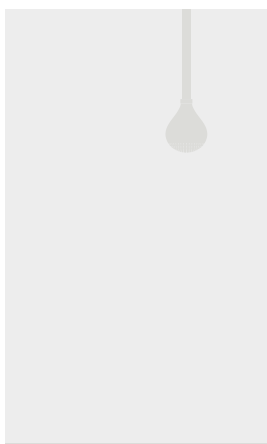

Ceiling mounted

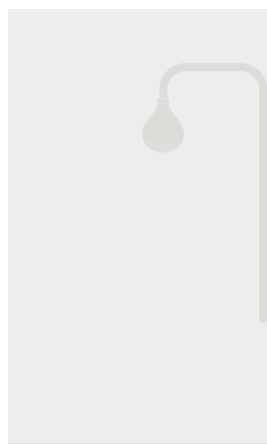

Shower column

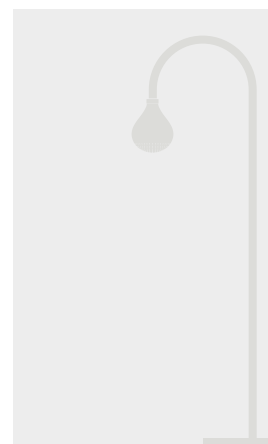

Free standing shower

Drop

MONAMOUR

Round and square rain over your head.

Pioggia rotonda e quadrata sopra la tua testa.
Une pluie ronde et carrée au-dessus de ta tête.

The Monamour showerheads collection represents the best solution for those who look for character and originality in their shower. Available in sixteen different finishes, Monamour offers a wide selection of showerheads, seven round and seven square, different in size and thickness, built-in or ceiling-mounted, thus offering a product adaptable to every individual taste and need and free from constraints.

La collezione soffioni Monamour rappresenta la migliore soluzione per chi ricerca personalità e originalità nella propria doccia. Disponibile in sedici finiture diverse, Monamour offre un'ampia scelta di soffioni, sette di forma rotonda e altrettanti di forma quadrata, diversi in dimensioni e spessore, incassati o a soffitto, garantendo così un prodotto adattabile a ogni singolo gusto ed esigenza e libero da costrizioni.

La collection de pommes de douche Monamour représente la meilleure solution pour ceux qui cherchent forte personnalité et originalité dans leur douche. Disponible en seize finitions différentes, Monamour offre un large choix de pommes de douche, sept de forme ronde et autant de forme carrée, de taille et d'épaisseur différentes, encastrés ou à plafond, garantissant un produit adaptable à chaque goût et besoin, et sans aucune contrainte.



LEAD FREE



ZINC FREE







↑ MA050RS
Round Showerhead Ø500 mm
Soffione tondo Ø500 mm
Tête de douche ronde Ø500 mm

→ MA033CC
Built-in stainless-steel round showerhead Ø332 mm
Soffione tondo Ø332 mm a incasso in acciaio inox
Tête de douche ronde encastré Ø332 mm en
acier inoxydable





ARTICLE | ARTICOLO | ARTICLE

MA012

Round Tradition Showerhead Ø200 mm

Soffione tondo Tradition Ø200 mm

Tête de douche ronde Tradition Ø200 mm

CODE / COEFFICIENT | CODICE /
COEFFICIENTE | CODE / COEFFICIENT

● CC	MA012CC	6,0
● PL	MA012PL	9,6
● SS	MA012SS	7,5
● II	MA012II	9,0
● RS	MA012RS	9,0
● OS	MA012OS	9,6
● RR	MA012RR	7,8
● BB	MA012BB	7,8

PACKAGING

L: 240 mm
D: 215 mm
H: 110 mm

1,2 kg

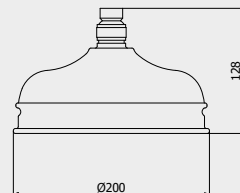

ARTICLE | ARTICOLO | ARTICLE

MA020

Round Showerhead Ø200 mm

Soffione tondo Ø200 mm

Tête de douche ronde Ø200 mm

CODE / COEFFICIENT | CODICE /
COEFFICIENTE | CODE / COEFFICIENT

● CC	MA020CC	3,8
● PL	MA020PL	6,1
● SS	MA020SS	4,8
● ON	MA020ON	4,6
● BO	MA020BO	4,6
● NP	MA020NP	4,8
● CF	MA020CF	5,7
● CS	MA020CS	6,1
● II	MA020II	5,7
● IS	MA020IS	6,1
● RS	MA020RS	5,7
● SR	MA020SR	6,1
● OO	MA020OO	5,7
● OS	MA020OS	6,1
● RR	MA020RR	5,3
● BB	MA020BB	5,3

PACKAGING

L: 210 mm
D: 210 mm
H: 70 mm

0,5 kg

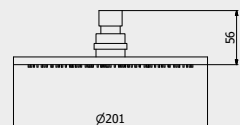

ARTICLE | ARTICOLO | ARTICLE

MA025

Round Showerhead Ø250 mm

Soffione tondo Ø250 mm

Tête de douche ronde Ø250 mm

CODE / COEFFICIENT | CODICE /
COEFFICIENTE | CODE / COEFFICIENT

● CC	MA025CC	4,3
● PL	MA025PL	6,9
● SS	MA025SS	5,4
● ON	MA025ON	5,2
● BO	MA025BO	5,2
● NP	MA025NP	5,4
● CF	MA025CF	6,5
● CS	MA025CS	6,9
● II	MA025II	6,5
● IS	MA025IS	6,9
● RS	MA025RS	6,5
● SR	MA025SR	6,9
● OO	MA025OO	6,5
● OS	MA025OS	6,9
● RR	MA025RR	6,0
● BB	MA025BB	6,0

PACKAGING

L: 265 mm
D: 260 mm
H: 70 mm

1,4 kg



ARTICLE | ARTICOLO | ARTICLE

MA030

Round Showerhead Ø300 mm

Soffione tondo Ø300 mm

Tête de douche ronde Ø300 mm

CODE / COEFFICIENT | CODICE /
COEFFICIENTE | CODE / COEFFICIENT

● CC	MA030CC	7,7
● PL	MA030PL	12,3
● SS	MA030SS	9,6
● ON	MA030ON	9,2
● BO	MA030BO	9,2
● NP	MA030NP	9,6
● CF	MA030CF	11,6
● CS	MA030CS	12,3
● II	MA030II	11,6
● IS	MA030IS	12,3
● RS	MA030RS	11,6
● SR	MA030SR	12,3
● OO	MA030OO	11,6
● OS	MA030OS	12,3
● RR	MA030RR	10,8
● BB	MA030BB	10,8

PACKAGING

L: 330 mm
D: 325 mm
H: 75 mm

3,2 kg

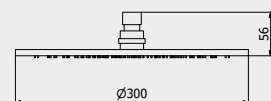

ARTICLE | ARTICOLO | ARTICLE

MA040



Round Showerhead Ø400 mm
Soffione tondo Ø400 mm
Tête de douche ronde Ø400 mm



CODE / COEFFICIENT CODICE / COEFFICIENTE	CODE / COEFFICIENT CODICE / COEFFICIENTE	COEFFICIENTE
CC	MA040CC	12,5
PL	MA040PL	20,0
SS	MA040SS	15,6
BO	MA040BO	15,0
NP	MA040NP	15,6
CF	MA040CF	18,8
CS	MA040CS	20,0
II	MA040II	18,8
IS	MA040IS	20,0
RS	MA040RS	18,8
SR	MA040SR	20,0
OO	MA040OO	18,8
OS	MA040OS	20,0
RR	MA040RR	17,5
BB	MA040BB	17,5

PACKAGING

L: 556 mm
D: 565 mm
H: 99 mm

3,3 kg

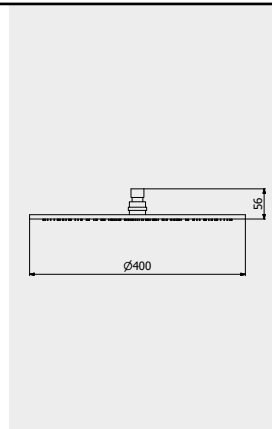

ARTICLE | ARTICOLO | ARTICLE

MA050



Round Showerhead Ø500 mm
Soffione tondo Ø500 mm
Tête de douche ronde Ø500 mm

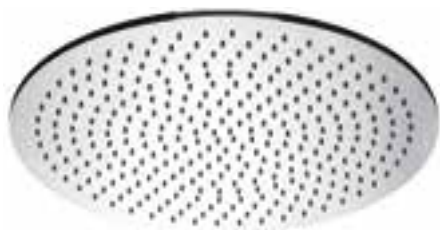

CODE / COEFFICIENT CODICE / COEFFICIENTE	CODE / COEFFICIENT CODICE / COEFFICIENTE	COEFFICIENTE
CC	MA050CC	21,6
PL	MA050PL	34,6
SS	MA050SS	27,0
BO	MA050BO	25,9
NP	MA050NP	27,0
CF	MA050CF	32,4
CS	MA050CS	34,6
II	MA050II	32,4
IS	MA050IS	34,6
RS	MA050RS	32,4
SR	MA050SR	34,6
OO	MA050OO	32,4
OS	MA050OS	34,6
RR	MA050RR	30,2
BB	MA050BB	30,2

PACKAGING

L: 556 mm
D: 565 mm
H: 99 mm

7,6 kg

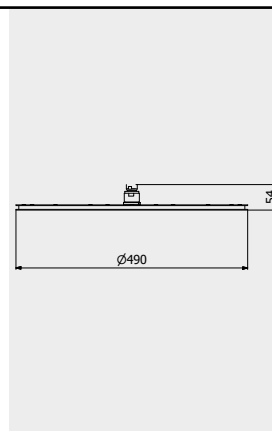

ARTICLE | ARTICOLO | ARTICLE

MA033



Built-in stainless-steel round showerhead Ø332 mm
Soffione tondo Ø332 mm a incasso in acciaio inox
Tête de douche ronde encastré Ø332 mm en acier inoxydable



CODE / COEFFICIENT CODICE / COEFFICIENTE	CODE / COEFFICIENT CODICE / COEFFICIENTE	COEFFICIENTE
CC	MA033CC	15,5

PACKAGING

L: 330 mm
D: 325 mm
H: 75 mm

2,9 kg

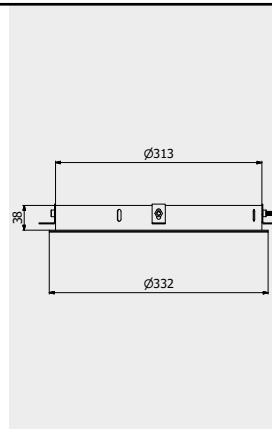

ARTICLE | ARTICOLO | ARTICLE

MA060



Shower arm with integrated shower aerator
Braccio doccia con aeratore doccia integrato
Bras de douche avec aérateur de douche intégré



CODE / COEFFICIENT CODICE / COEFFICIENTE	CODE / COEFFICIENT CODICE / COEFFICIENTE	COEFFICIENTE
CC	MA060CC	3,1
PL	MA060PL	5,0
SS	MA060SS	3,9
ON	MA060ON	3,1
BO	MA060BO	3,8
NP	MA060NP	3,8
CF	MA060CF	4,7
CS	MA060CS	5,0
II	MA060II	4,7
IS	MA060IS	5,0
RS	MA060RS	4,7
SR	MA060SR	5,0
OO	MA060OO	4,7
OS	MA060OS	5,0
RR	MA060RR	4,0
BB	MA060BB	4,0

PACKAGING

L: 150 mm
D: 190 mm
H: 98 mm

0,4 kg

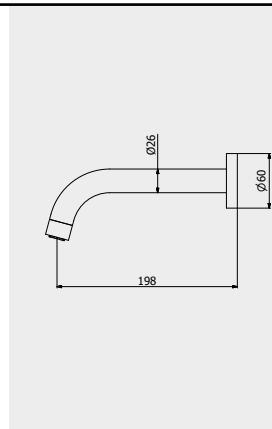

Monamour

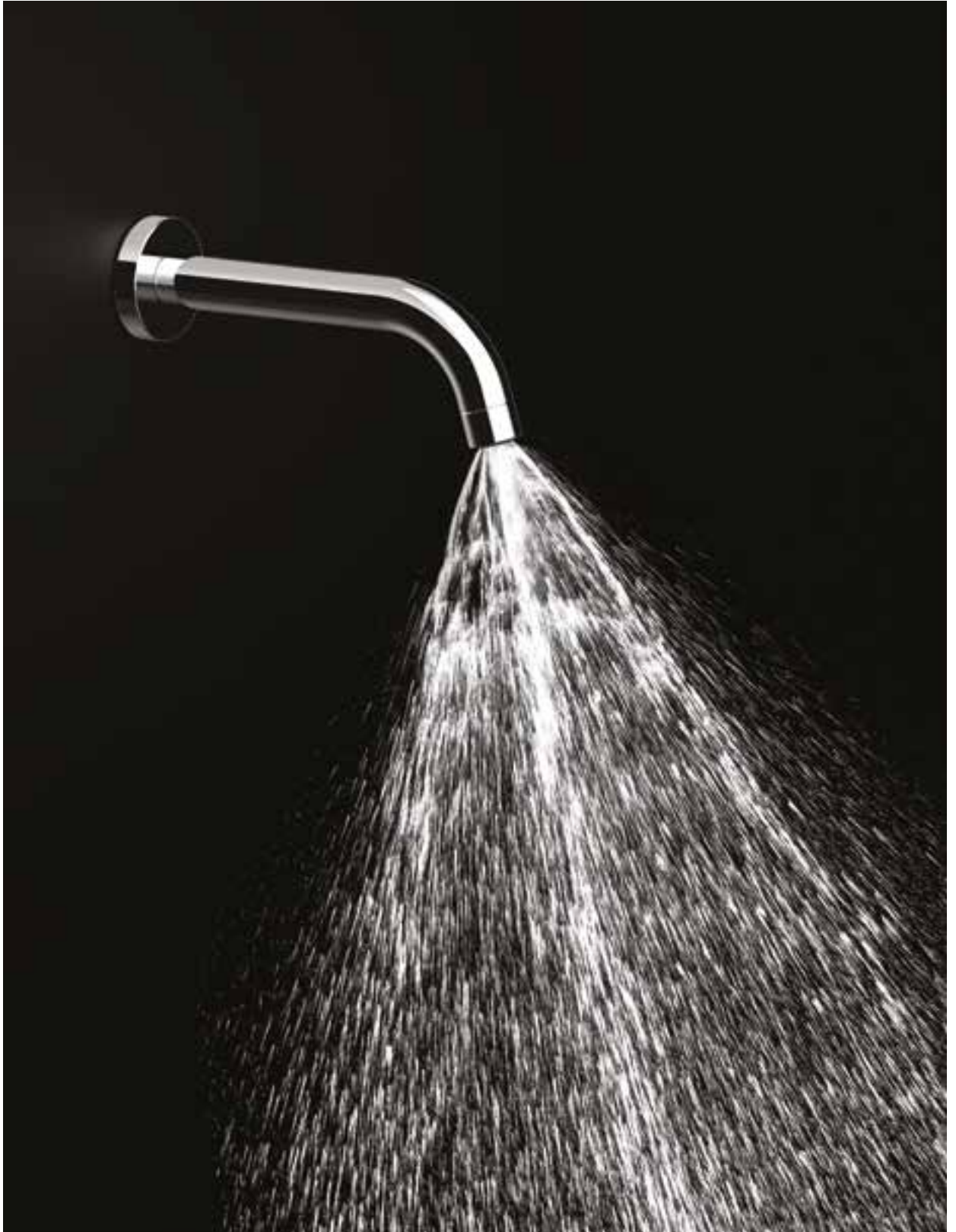

↑ MA060CC
Shower arm with integrated shower aerator
Braccio doccia con areatore doccia integrato
Bras de douche avec aérateur de douche intégré

→ MA051CC
Square Showerhead 500x500 mm
Soffione quadro 500x500 mm
Tête de douche carré 500x500 mm





ARTICLE | ARTICOLO | ARTICLE

MA021

Square Showerhead 200x200 mm
Soffione quadro 200x200 mm
Tête de douche carré 200x200 mm

CODE / COEFFICIENT | CODICE /
COEFFICIENTE | CODE / COEFFICIENT

● CC	MA021CC	4,2
● PL	MA021PL	6,7
● SS	MA021SS	5,3
● ON	MA021ON	5,0
● BO	MA021BO	5,0
● NP	MA021NP	5,3
● CF	MA021CF	6,3
● CS	MA021CS	6,7
● II	MA021II	6,3
● IS	MA021IS	6,7
● RS	MA021RS	6,3
● SR	MA021SR	6,7
● OO	MA021OO	6,3
● OS	MA021OS	6,7
● RR	MA021RR	5,9
● BB	MA021BB	5,9

PACKAGING

L: 210 mm
D: 210 mm
H: 70 mm

1,5 kg

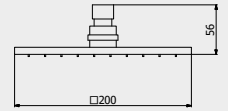

ARTICLE | ARTICOLO | ARTICLE

MA026

Square Showerhead 250x250 mm
Soffione quadro 250x250 mm
Tête de douche carré 250x250 mm

CODE / COEFFICIENT | CODICE /
COEFFICIENTE | CODE / COEFFICIENT

● CC	MA026CC	5,0
● PL	MA026PL	8,0
● SS	MA026SS	6,3
● ON	MA026ON	6,0
● BO	MA026BO	6,0
● NP	MA026NP	6,3
● CF	MA026CF	7,5
● CS	MA026CS	8,0
● II	MA026II	7,5
● IS	MA026IS	8,0
● RS	MA026RS	7,5
● SR	MA026SR	8,0
● OO	MA026OO	7,5
● OS	MA026OS	8,0
● RR	MA026RR	7,0
● BB	MA026BB	7,0

PACKAGING

L: 265 mm
D: 260 mm
H: 70 mm

1,6 kg

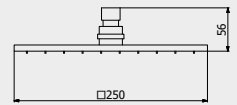

ARTICLE | ARTICOLO | ARTICLE

MA031

Square Showerhead 300x300 mm
Soffione quadro 300x300 mm
Tête de douche carré 300x300 mm

CODE / COEFFICIENT | CODICE /
COEFFICIENTE | CODE / COEFFICIENT

● CC	MA031CC	9,0
● PL	MA031PL	14,4
● SS	MA031SS	11,3
● ON	MA031ON	10,8
● BO	MA031BO	10,8
● NP	MA031NP	11,3
● CF	MA031CF	13,5
● CS	MA031CS	14,4
● II	MA031II	13,5
● IS	MA031IS	14,4
● RS	MA031RS	13,5
● SR	MA031SR	14,4
● OO	MA031OO	13,5
● OS	MA031OS	14,4
● RR	MA031RR	12,6
● BB	MA031BB	12,6

PACKAGING

L: 330 mm
D: 325 mm
H: 75 mm

3,7 kg

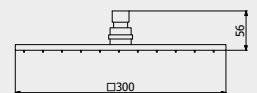

ARTICLE | ARTICOLO | ARTICLE

MA032

Square Showerhead 300x200 mm
Soffione quadro 300x200 mm
Tête de douche carré 300x200 mm

CODICE / COEFFICIENTE | CODE /
COEFFICIENT

● CC	MA032CC	7,2
------	---------	-----

PACKAGING

L: 340 mm
D: 210 mm
H: 80 mm

1,9 kg

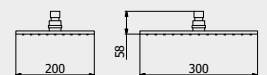

ARTICLE | ARTICOLO | ARTICLE

MA041



Square Showerhead 400x400 mm
Soffione quadro 400x400 mm
Tête de douche carré 400x400 mm



CODE / COEFFICIENT	CODICE / COEFFICIENTE	
CC	MA041CC	14,0
PL	MA041PL	22,4
SS	MA041SS	17,5
BO	MA041BO	16,8
NP	MA041NP	17,5
CF	MA041CF	21,0
CS	MA041CS	22,4
II	MA041II	21,0
IS	MA041IS	22,4
RS	MA041RS	21,0
SR	MA041SR	22,4
OO	MA041OO	21,0
OS	MA041OS	22,4
RR	MA041RR	19,6
BB	MA041BB	19,6

PACKAGING

L: 556 mm
D: 565 mm
H: 99 mm

4,4 kg

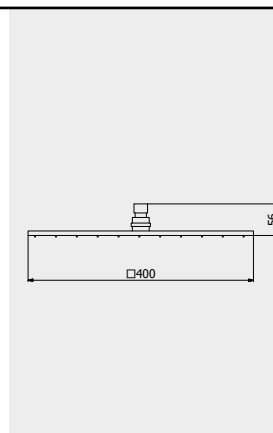

ARTICLE | ARTICOLO | ARTICLE

MA051



Square Showerhead 500x500 mm
Soffione quadro 500x500 mm
Tête de douche carré 500x500 mm

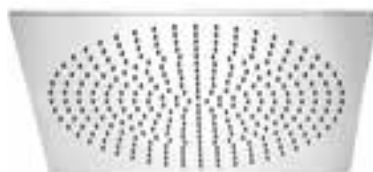

CODE / COEFFICIENT	CODICE / COEFFICIENTE	
CC	MA051CC	22,1
PL	MA051PL	35,4
SS	MA051SS	27,6
BO	MA051BO	26,5
NP	MA051NP	27,6
CF	MA051CF	33,2
CS	MA051CS	35,4
II	MA051II	33,2
IS	MA051IS	35,4
RS	MA051RS	33,2
SR	MA051SR	35,4
OO	MA051OO	33,2
OS	MA051OS	35,4
RR	MA051RR	30,9
BB	MA051BB	30,9

PACKAGING

L: 556 mm
D: 565 mm
H: 99 mm

8,7 kg

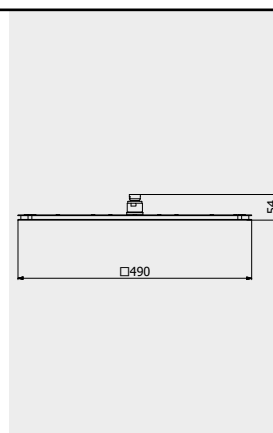

ARTICLE | ARTICOLO | ARTICLE

MA034



Built-in stainless-steel square showerhead 332x332 mm
Soffione quadro 332x332 mm a incasso in acciaio inox
Tête de douche carré encastré 332x332 mm en acier inoxydable



CODE / COEFFICIENT	CODICE / COEFFICIENTE	
CC	MA034CC	17,1

PACKAGING

L: 330 mm
D: 325 mm
H: 75 mm

3,4 kg

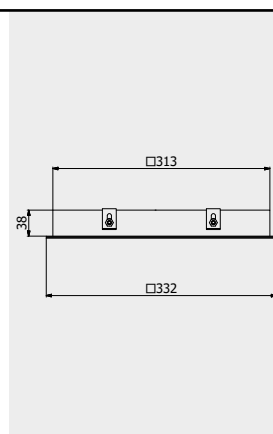

ARTICLE | ARTICOLO | ARTICLE

SH005



EASY arms and showerhead

Soffioncino con braccio EASY

Petite tête de douche avec bras EASY

CODE / COEFFICIENT | CODICE /
COEFFICIENTE | CODE / COEFFICIENT

CC SH005CC 1,4

PACKAGING

L: 175 mm
D: 125 mm
H: 90 mm

0,4 kg

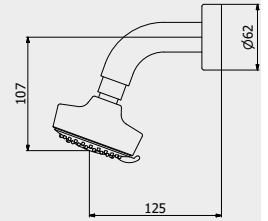

ARTICLE | ARTICOLO | ARTICLE

SH006



ABS round showerhead

Soffione tondo ABS

Tête de douche rond ABS

CODE / COEFFICIENT | CODICE /
COEFFICIENTE | CODE / COEFFICIENT

CC SH006CC 1,6

PACKAGING

L: 230 mm
D: 210 mm
H: 90 mm

1,0 kg

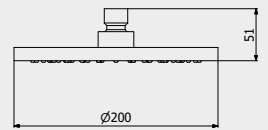

ARTICLE | ARTICOLO | ARTICLE

SH007



ABS square showerhead

Soffione quadro ABS

Tête de douche carré ABS

CODE / COEFFICIENT | CODICE /
COEFFICIENTE | CODE / COEFFICIENT

CC SH007CC 2,1

PACKAGING

L: 230 mm
D: 210 mm
H: 90 mm

1,0 kg

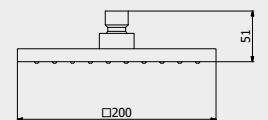

ARTICLE | ARTICOLO | ARTICLE

SH050



Round wall shower arm

Braccio doccia parete tondo

Bras de douche murale ronde

CC	SH050CC	1,8
SS	SH050SS	2,3
BO	SH050BO	2,2
NP	SH050NP	2,3
CF	SH050CF	2,7
CS	SH050CS	2,9
OO	SH050OO	2,7
II	SH050II	2,7
IS	SH050IS	2,9
RS	SH050RS	2,7
SR	SH050SR	2,9
OS	SH050OS	2,9
BB	SH050BB	2,5
RR	SH050RR	2,5
ON	SH050ON	1,8
PL	SH050PL	2,9

PACKAGING

L: 455 mm
D: 107 mm
H: 41 mm

0,7 kg



ARTICLE | ARTICOLO | ARTICLE

SH052



Square wall shower arm
Braccio doccia parete quadro
Bras de douche murale carré

CC	SH052CC	2,3
SS	SH052SS	2,9
BO	SH052BO	2,8
NP	SH052NP	2,9
CF	SH052CF	3,5
CS	SH052CS	3,7
OO	SH052OO	3,5
II	SH052II	3,5
IS	SH052IS	3,7
RS	SH052RS	3,5
SR	SH052SR	3,7
OS	SH052OS	3,7
BB	SH052BB	3,2
RR	SH052RR	3,2
PL	SH052PL	3,7

PACKAGING

L: 455 mm
D: 107 mm
H: 41 mm

0,7 kg



ARTICLE | ARTICOLO | ARTICLE

SH054



Round EXTRA-STRONG wall shower arm L 450 mm
Braccio doccia parete tondo RINFORZATO L 450 mm
Bras de douche au plafond ronde RENFORCÉ L 450 mm

CC	SH054CC	5,2
SS	SH054SS	6,5
BO	SH054BO	6,2
NP	SH054NP	6,5
CF	SH054CF	7,8
CS	SH054CS	8,3
OO	SH054OO	7,8
II	SH054II	7,8
IS	SH054IS	8,3
RS	SH054RS	7,8
SR	SH054SR	8,3
OS	SH054OS	8,3
BB	SH054BB	7,3
RR	SH054RR	7,3
PL	SH054PL	8,3

PACKAGING

L: 540 mm
D: 130 mm
H: 70 mm

1,3 kg



ARTICLE | ARTICOLO | ARTICLE

SH053



Square ceiling shower arm
Braccio doccia soffitto quadro
Bras de douche au plafond carré

CC	SH053CC	2,3
SS	SH053SS	2,9
BO	SH053BO	2,8
NP	SH053NP	2,9
CF	SH053CF	3,5
CS	SH053CS	3,7
OO	SH053OO	3,5
II	SH053II	3,5
IS	SH053IS	3,7
RS	SH053RS	3,5
SR	SH053SR	3,7
OS	SH053OS	3,7
BB	SH053BB	3,2
RR	SH053RR	3,2
ON	SH053ON	2,3
PL	SH053PL	3,7

PACKAGING

L: 455 mm
D: 107 mm
H: 41 mm

0,7 kg



ARTICLE | ARTICOLO | ARTICLE

SH051



Round ceiling shower arm
Braccio doccia soffitto tondo
Bras de douche au plafond ronde

CC	SH051CC	2,3
SS	SH051SS	2,9
BO	SH051BO	2,8
NP	SH051NP	2,9
CF	SH051CF	3,5
CS	SH051CS	3,7
OO	SH051OO	3,5
II	SH051II	3,5
IS	SH051IS	3,7
RS	SH051RS	3,5
SR	SH051SR	3,7
OS	SH051OS	3,7
BB	SH051BB	3,2
RR	SH051RR	3,2
ON	SH051ON	2,3
PL	SH051PL	3,7

PACKAGING

L: 455 mm
D: 107 mm
H: 41 mm

0,7 kg

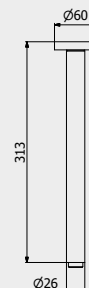

Monamour



Interactive PDF, you can view the collection directly by clicking on it.
PDF interattivo, per visualizzare direttamente la collezione basta cliccarci sopra.
PDF interactif, vous pouvez voir la collection directement en cliquant dessus.



WALLPAPER
P. 632



MONAMOUR
P. 638



OTHER
P. 642

SHOWER

COLUMNS

COLONNE DOCCIA
COLONNE DE DOUCHE

WALLPAPER

The luxury understatement by iB Rubinetti.

L'understatement secondo iB Rubinetti.

L'understatement de luxe selon iB Rubinetti.

Multi-functional shower in pure steel, WALLPAPER is the hidden gem in the IB Rubinetti collections. The shower is composed by an entirely built-in column, a wall level steel panel and controls that can monitor the use and intensity of three jets, employable independently or simultaneously thanks to the multifunctional control and completed by an efficient and accurate thermostatic regulator to set the required temperature.

Doccia multifunzionale in puro acciaio, WALLPAPER è la perla nascosta delle collezioni IB Rubinetti. Con una colonna completamente incassata e un pannello in acciaio perfettamente a raso parete, la doccia dispone di comandi per regolare l'utilizzo e l'intensità di tre getti, adoperabili autonomamente o in contemporanea grazie al comando multifunzione e integrati da un regolatore termostatico efficiente e ricettivo per impostare la temperatura desiderata.

Douche multifonctionnelle en pur acier, WALLPAPER est la merveille cachée des collections IB Rubinetti. Avec une colonne complètement encastrée et un panneau en acier parfaitement au ras du mur, la douche dispose de commandes pour la régulation de l'usage et de l'intensité de trois jets, utilisables indépendamment ou simultanément grâce au tableau de commande multifonctionnel et intégrés par un thermostat efficace et réceptif.



LEAD FREE



ZINC FREE







Equipped with four handles to regulate the showerhead and lateral jets, the intensity of the hand shower and the temperature, WALLPAPER also comes with directional bodyjets, easily manageable from the control panel.

Dotata di quattro manopole per regolare i getti a soffione e laterali, l'intensità del doccino e la temperatura dell'acqua, la doccia è inoltre costituita da bodyjet facilmente direzionabili e gestibili dal pannello di comando.

Dotée de quatre poignées réglant le pomme de douche et les jets latéraux, l'intensité de la douchette et la température de l'eau, la douche WALLPAPER est également composée de bodyjet réglables et gérables par le tableau de commande.

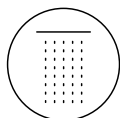

Showerhead

Doccia
Douche

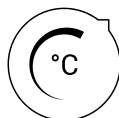

Thermostatic control

Comando termostatico
Régulation thermostatique

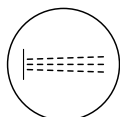

Adjustable bodyjet

Bodyjet direzionabili
Bodyjet directionnel

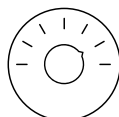

Free intensity adjustment

Regolazione intensità indipendente
Réglage indépendant de l'intensité



Handshower

Doccino
Douchette

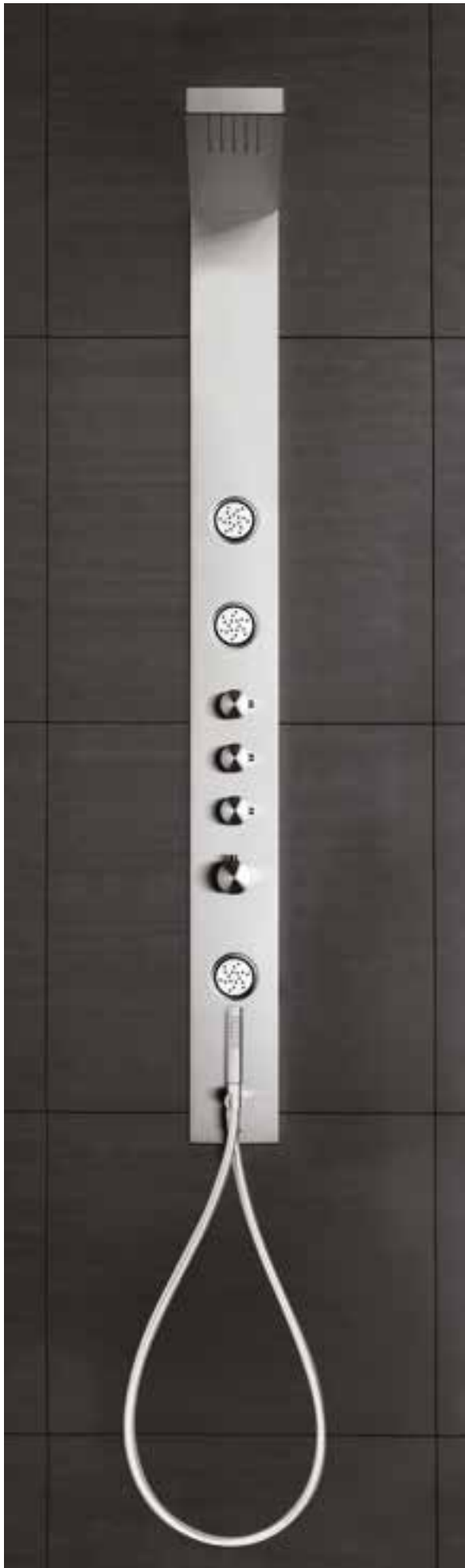



WATER FLOW | PORTATE | DÉBIT D'EAU

	1 BAR	2 BAR	3 BAR
Head shower Soffione Tête de douche	6 l/m	7,8 l/m	6,2 l/m
Shower Doccino Douchette	9 l/m	11,5 l/m	9 l/m
Body Jet Body Jet Body Jet	11 l/m	14,2 l/m	11 l/m

PACKAGING

L: 1535 mm D: 220 mm H: 235 mm 17,5 kg

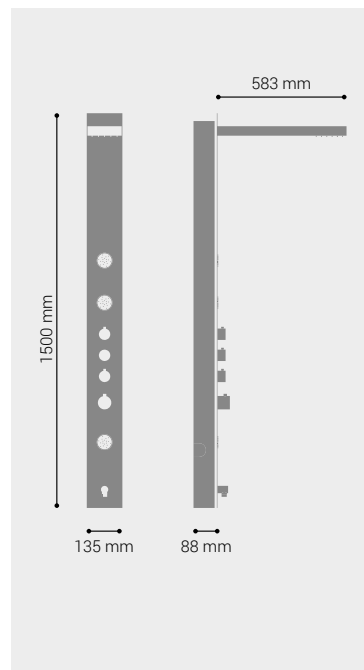

FITTING INSTRUCTIONS | ISTRUZIONI DI MONTAGGIO | INSTRUCTIONS DE MONTAGE

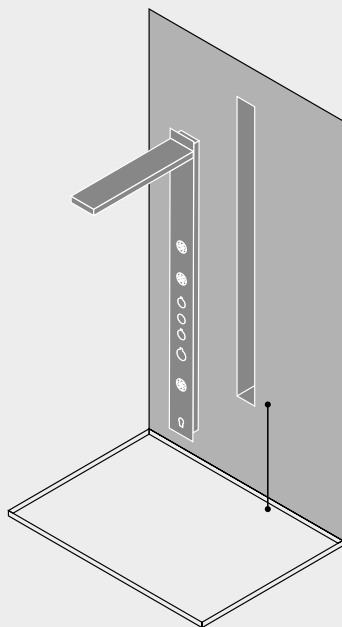

Concealed stainless steel installation box
Carter di Installazione in acciaio
Boîtier d'installation en acier

Distance from the floor 500mm
Distanza da terra 500 mm
Distance du sol 500mm

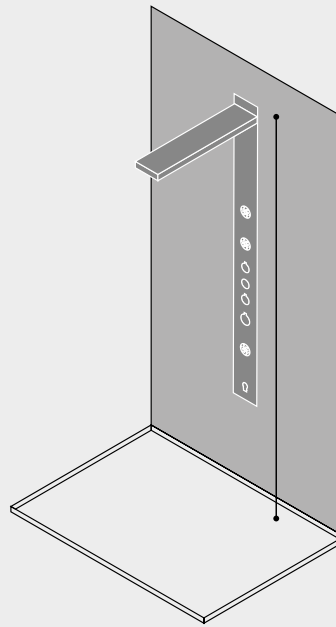

Distance between shower head to shower
base 2000 mm
Distanza del soffione dal piatto
doccia 2000 mm
Distance de la tête de douche du bac à
douche 2000 mm

Wallpaper

MONAMOUR

The properties of a cuddle in the shower.

La qualità di una coccola in una doccia.
Les propriétés d'un câlin sous la douche.

MONAMOUR shower columns display the same high qualities of the showerheads collection: high functionality, easy to use, essential and sophisticated aesthetics. The efficiency of the thermostatic functions is combined with at the choice of quality materials . The shower is supplemented by two lateral jets and an easy-to-use and high-quality temperature and functions control system.

Le colonne doccia MONAMOUR rispecchiano tutte le alte qualità dei soffioni della collezione: alta funzionalità, facile utilizzo, estetica essenziale ed elegante. L'efficienza delle funzioni termostatiche combinata alla scelta di materiali di qualità. La doccia è completata dalla presenza di due getti laterali e da un sistema di comando della temperatura e delle funzioni di facile utilizzo e di alta qualità.

Les colonnes de douche MONAMOUR reflètent toutes les qualités des pommes de douche de la même collection: haute fonctionnalité, facilité d'utilisation, style essentiel et élégant. L'efficacité des fonctions thermostatiques est combinée au choix de matériaux de qualité. La douche est dotée de deux jets latéraux et d'un système de contrôle thermostatique très pratique et de haute qualité



LEAD FREE



ZINC FREE







In pure steel, MONAMOUR columns can be wall-mounted or built-in, according to the setting needs and the aesthetic preferences. They are all equipped with an efficient and functional thermostatic control, with an anti-limestone food safe silicone showerhead and a brass hand shower supplemented with a cromoloux hose.

In puro acciaio, le colonne MONAMOUR possono essere installate a parete o a incasso, secondo le necessità dell'ambiente e le preferenze estetiche. Sono tutte dotate di un comando termostatico efficiente e funzionale, di un soffione in silicone alimentare anticalcare e di un doccino in ottone integrato con flessibile Cromoloux.

Fabriquées en pur acier, les colonnes MONAMOUR peuvent être fixées au mur ou encastrées, selon les nécessités du milieu et les préférences esthétiques. Elles sont toutes dotées d'un contrôle thermostatique efficace et fonctionnel, d'un pomme de douche en silicone alimentaire anticalcaire et d'une douchette en laiton intégrée avec tuyau flexible Cromoloux.

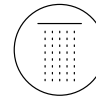

Showerhead

Doccia
Douche

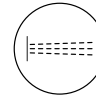

Bodyjet

Getti laterali
Bodyjet

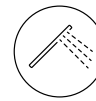

Hand shower

Doccino
Douchette

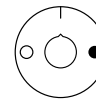

Function control

Controllo delle funzioni
Contrôle des fonctions

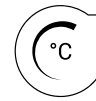

Thermostatic control

Comando termostatico
Régulation thermostatique

ARTICLE | ARTICOLO | ARTICLE

MA800



Polished steel free-standing shower column

Colonna doccia termostatica a parete

Colonne de douche thermostatique murale

CODE / COEFFICIENT | CODICE / COEFFICIENTE | CODE / COEFFICIENT

CC MA800CC 65,0

WATER FLOW | PORTATE | DÉBIT D'EAU

	1 BAR	2 BAR	3 BAR
Soffione Head shower Tête de douche	7,2 l/m	6,5 l/m	7,3 l/m
Doccino Shower Douchette	10,4 l/m	9,5 l/m	10,5 l/m
Body Jet Body Jet Body Jet	13 l/m	11,6 l/m	13 l/m

PACKAGING

L: 1535 mm D: 220 mm H: 235 mm 17,5 kg

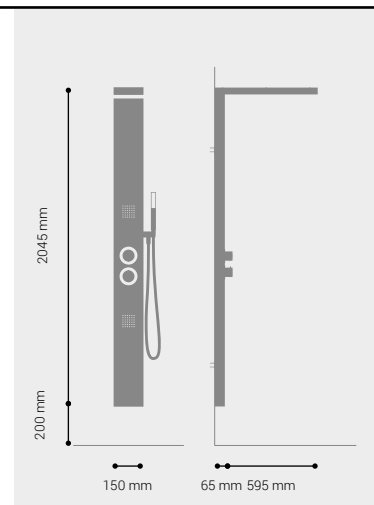

Monamour

SHOWER COLUMNS

In order to satisfy every taste and need, we have created a family of eight shower columns, perfect for any setting and innovative in their technology. The Shower Columns are all characterized by essential and refined geometric lines, round or square, and by a service suitable for every need, thanks to their thermostatic controls and first choice mixers. All columns are made of brass, available in twelve finishes and supplied with anti-limestone silicone membranes.

Per soddisfare ogni gusto ed esigenza, abbiamo creato una famiglia di otto colonne doccia, perfette per ogni ambiente e innovative nella loro tecnologia. Le colonne doccia sono tutte caratterizzate da linee geometriche essenziali e raffinate, rotonde o quadrate, e da un servizio adatto ad ogni esigenza, grazie ai comandi termostatici e ai miscelatori di prima scelta. Tutte le colonne sono realizzate in ottone, disponibili in dodici finiture e fornite con membrane siliconiche anticalcare.

Pour satisfaire tous les goûts et les besoins, nous avons créé une famille de huit colonnes de douche, idéales pour tout environnement et innovantes dans leur technologie. Les colonnes de douche se caractérisent par des lignes géométriques, rondes ou carrées, au design sobre et élégant et par un service fonctionnel à chaque besoin, grâce à ses commandes thermostatiques et ses mélangeurs de premier choix. Toutes les colonnes sont en laiton, disponibles en douze finitions et équipées de membranes en silicone anticalcaire.



LEAD FREE



ZINC FREE



OUTDOOR

THERMOSTATIC
VALVE



Shower columns

ARTICLE | ARTICOLO | ARTICLE

MA125



Mixer shower column with round showerhead and hand shower
Colonna doccia con miscelatore, soffione tondo e doccia
Colonne de douche mitigeur avec tête de douche et douchette rondes

CODE / COEFFICIENT | CODICE /
COEFFICIENTE | CODE / COEFFICIENT

● CC MA125CC 20,9
● NP MA125NP 26,1

PACKAGING

● L: 1020 mm
D: 490 mm
H: 120 mm

● 10,3 kg

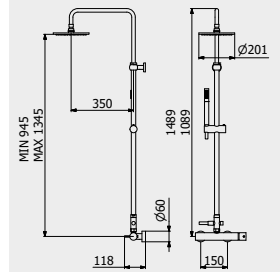

WATER FLOW | PORTATE | DÉBIT D'EAU

1 BAR	2 BAR	3 BAR
10,5 l/m	15,5 l/m	19 l/m

ARTICLE | ARTICOLO | ARTICLE

MA126



Mixer shower column with square showerhead and hand shower
Colonna doccia con miscelatore, soffione quadrato e doccia
Colonne de douche mitigeur avec tête de douche et douchette carré

CODE / COEFFICIENT | CODICE /
COEFFICIENTE | CODE / COEFFICIENT

● CC MA126CC 26,3
● NP MA126NP 32,9

PACKAGING

● L: 1020 mm
D: 490 mm
H: 120 mm

● 10,3 kg

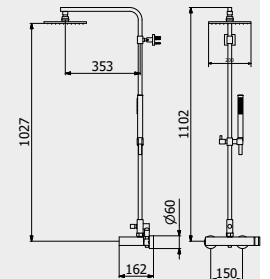

WATER FLOW | PORTATE | DÉBIT D'EAU

1 BAR	2 BAR	3 BAR
10 l/m	15 l/m	18,5 l/m

ARTICLE | ARTICOLO | ARTICLE

MT127



Mixer shower column Whynot with round showerhead and hand shower
 Colonna doccia Whynot con miscelatore, soffione tondo e docciaino
 Colonne de douche Whynot mitigeur avec tête de douche et douchette rondes

CODE / COEFFICIENT	CODICE / COEFFICIENTE	COEFFICIENT
☰ CC	MT127CC	17,5
● NP	MT127NP	20

PACKAGING

📦 L: 1500 mm
 D: 535 mm
 H: 120 mm

🏋️ 10,3 kg

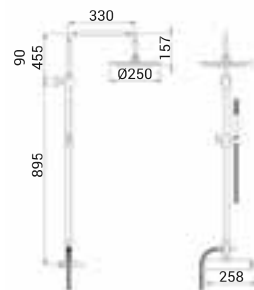

PORTATE | WATER FLOW | DÉBIT D'EAU

1 BAR	2 BAR	3 BAR
10,5 l/m	15,5 l/m	19 l/m

ARTICLE | ARTICOLO | ARTICLE

B2800



Bold thermostatic shower column with shower kit
 Colonna doccia Bold termostatica con kit doccia
 Bold Colonne de douche thermostatique avec kit douche

CODE / COEFFICIENT	CODICE / COEFFICIENTE	COEFFICIENT
☰ CC	B2800CC	53,7
☷ SS	B2800SS	67,1
● ON	B2800ON	53,7
● NP	B2800NP	64,4
● CF	B2800CF	80,6
● CS	B2800CS	85,9
● II	B2800II	80,6
● IS	B2800IS	85,9
● RS	B2800RS	80,6
● SR	B2800SR	85,9
● OO	B2800OO	80,6
● OS	B2800OS	85,9

PACKAGING

📦 L: 800 mm
 D: 500 mm
 H: 180 mm

🏋️ 12,1 kg

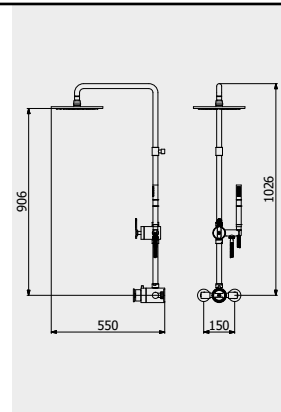

🔴 _6	LEVA ROSSA RED LEVER LEVIER ROUGE	+ 0,2
------	---------------------------------------	-------

PORTATE | WATER FLOW | DÉBIT D'EAU

	1 BAR	2 BAR	3 BAR
Acqua miscelata / Mixed water / Eau mélangée	10,7 l/m	15 l/m	18,5 l/m
Doccetta / Handshower / Douchette	6,7 l/m	9,6 l/m	11,9 l/m

Shower columns

ARTICLE | ARTICOLO | ARTICLE

ID800



Industria thermostatic shower column with shower kit

Colonna doccia Industria termostatica con kit doccia

Industria colonne de douche thermostatique avec kit douche

CODE / COEFFICIENT | CODICE / COEFFICIENTE | CODE / COEFFICIENT

BODY | CORPO | CORPS

LEVER | LEVA | LEVIER



+



● CC	ID800CC	30,8
● SS	ID800SS	46,1
● ON	ID800ON	30,8
● NP	ID800NP	36,9
● CF	ID800CF	46,1
● CS	ID800CS	49,2
● II	ID800II	46,1
● IS	ID800IS	49,2
● RS	ID800RS	46,1
● SR	ID800SR	49,2
● OO	ID800OO	46,1
● OS	ID800OS	49,2



● CC	_1	5,4
● SS	_14	8,1
● ON	_10	5,4
● NP	_13	6,5
● CF	_3	8,1
● CS	_4	8,6
● II	_8	8,1
● IS	_9	8,6
● RS	_7	8,1
● SR	_14	8,6
● OO	_5	8,1
● OS	_9	8,6

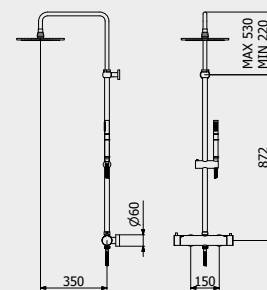

PORTATE | WATER FLOW | DÉBIT D'EAU

1 BAR	2 BAR	3 BAR
11,3 l/m	17 l/m	21,2 l/m

PACKAGING

L: 1020 mm
 D: 490 mm
 H: 120 mm

3,4 kg

ARTICLE | ARTICOLO | ARTICLE

MT801



Milano Torino thermostatic shower column with shower kit

Colonna doccia Milano Torino termostatica con kit doccia

Milano Torino colonne de douche thermostatique avec kit douche

CODE / COEFFICIENT | CODICE / COEFFICIENTE | CODE / COEFFICIENT

● CC	MT801CC	34,4
● SS	MT801SS	43,0
● BO	MT801BO	41,3
● NP	MT801NP	41,3
● CF	MT801CF	51,7
● CS	MT801CS	55,1
● II	MT801II	51,7
● IS	MT801IS	55,1
● RS	MT801RS	51,7
● SR	MT801SR	55,1
● OO	MT801OO	51,7
● OS	MT801OS	55,1

PACKAGING

L: 1020 mm
 D: 490 mm
 H: 120 mm

3,4 kg

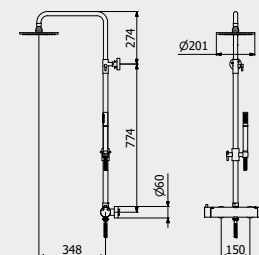

PORTATE | WATER FLOW | DÉBIT D'EAU

1 BAR	2 BAR	3 BAR
11,2 l/m	17 l/m	21,2 l/m

ARTICLE | ARTICOLO | ARTICLE

MT800



Milano Torino thermostatic shower column with shower kit
 Colonna doccia Milano Torino termostatica con kit doccia
 Milano Torino colonne de douche thermostatique avec kit douche

CODE / COEFFICIENT | CODICE /
 COEFFICIENTE | CODE / COEFFICIENT

CC MT800CC 28,3

PACKAGING

L: 1020 mm
 D: 490 mm
 H: 120 mm

3,4 kg

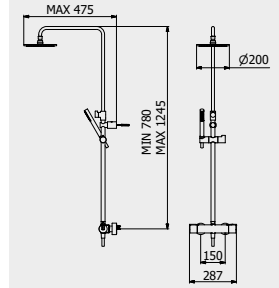

WATER FLOW | PORTATE | DÉBIT D'EAU

1 BAR	2 BAR	3 BAR
9 l/m	12 l/m	14,5 l/m

ARTICLE | ARTICOLO | ARTICLE

RU800



Rubacuori shower column thermostatic
 Colonna doccia Rubacuori termostatica
 Colonne de douche Rubacuori thermostatique

CODE / COEFFICIENT | CODICE /
 COEFFICIENTE | CODE / COEFFICIENT

CC RU800CC 33,2

PACKAGING

L: 1185 mm
 D: 415 mm
 H: 277 mm

4 kg

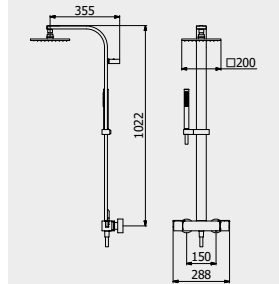

WATER FLOW | PORTATE | DÉBIT D'EAU

1 BAR	2 BAR	3 BAR
8 l/m	12 l/m	14,5 l/m

Shower
 columns

ARTICLE | ARTICOLO | ARTICLE

MA901



Floor standing indoor/outdoor shower column with showerhead

Doccione monocomando da terra

Colonne de douche du sol

CODE / COEFFICIENT | CODICE /
COEFFICIENTE | CODE / COEFFICIENT

SS MA901SS 65,0

PACKAGING

 L: 1250 mm
D: 355 mm
H: 245 mm

29 kg

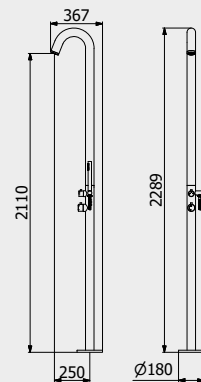

WATER FLOW | PORTATE | DÉBIT D'EAU

1 BAR	2 BAR	3 BAR
6,9 l/m	9,9 l/m	12,2 l/m

ARTICLE | ARTICOLO | ARTICLE

MA525



Floor standing indoor/outdoor shower column with showerhead

Doccione monocomando da terra

Colonne de douche du sol

CODE / COEFFICIENT | CODICE /
COEFFICIENTE | CODE / COEFFICIENT

CC MA525CC 45,0

ON MA525ON 45,0

PACKAGING

 L: 1500 mm
D: 535 mm
H: 120 mm

15,1 kg

CODE / COEFFICIENT | CODICE /
COEFFICIENTE | CODE / COEFFICIENT

CC MA526CC 45,6

ON MA526ON 45,6

CODE / COEFFICIENT | CODICE /
COEFFICIENTE | CODE / COEFFICIENT

CC MA501CC 42,8

ON MA501ON 42,8

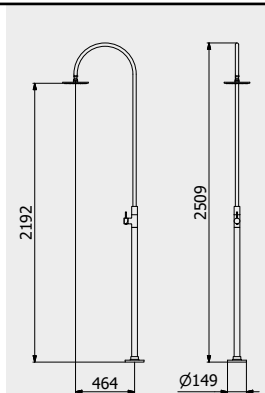

WATER FLOW | PORTATE | DÉBIT D'EAU

1 BAR	2 BAR	3 BAR
12,6 l/m	18,1 l/m	22,5 l/m

Built-in body to be purchased separately
AVAILABLE FROM JANUARY 2020Corpo incasso da acquistare separatamente
DISPONIBILE DA GENNAIO 2020Corps intégré à acheter séparément
DISPONIBLE À PARTIR DE JANVIER 2020

CODICE | CODE | CODE

INC399CCXN_19

COEFFICIENTE | COEFFICIENT | COEFFICIENT

2,8

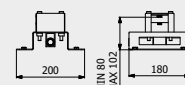



Shower
columns



Interactive PDF, you can view the collection directly by clicking on it.
PDF interattivo, per visualizzare direttamente la collezione basta cliccarci sopra.
PDF interactif, vous pouvez voir la collection directement en cliquant dessus.



HANDSHOWER
P. 652



DUPLEX
P. 654



SHOWER RAIL
P. 658



BODYJET
P. 660



SHUT OFF
P. 662



STOP VALVES
P. 663



WATER OUTLET
P. 664



BOTTLE TRAP
P. 665

SHOWER&

CO.

Handshower

Soffioni Doccia e Doccette
Tetes de douche et douchette

ARTICLE | ARTICOLO | ARTICLE

SH001



Round brass handshower

Doccia tonda in ottone

Douche rond en laiton

●	CC	SH001CC	1
●	SS	SH001SS	1,3
●	BO	SH001BO	1,2
●	NP	SH001NP	1,3
●	CF	SH001CF	1,5
●	CS	SH001CS	1,6
●	OO	SH001OO	1,5
●	II	SH001II	1,5
●	IS	SH001IS	1,6
●	RS	SH001RS	1,5
●	SR	SH001SR	1,6
●	OS	SH001OS	1,6
●	BB	SH001BB	1,4
●	RR	SH001RR	1,4
●	ON	SH001ON	1
●	PL	SH001PL	1,6

PACKAGING

L: 280 mm
D: 130 mm
H: 70 mm

0,5 kg

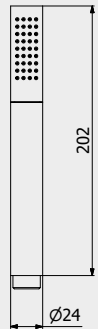

ARTICLE | ARTICOLO | ARTICLE

SH002



Square brass handshower

Doccia quadra in ottone

Douche carré en laiton

●	CC	SH002CC	1,1
●	SS	SH002SS	1,4
●	BO	SH002BO	1,3
●	NP	SH002NP	1,4
●	CF	SH002CF	1,7
●	CS	SH002CS	1,8
●	OO	SH002OO	1,7
●	II	SH002II	1,7
●	IS	SH002IS	1,8
●	RS	SH002RS	1,7
●	SR	SH002SR	1,8
●	OS	SH002OS	1,8
●	BB	SH002BB	1,5
●	RR	SH002RR	1,5
●	ON	SH002ON	1,1
●	PL	SH002PL	1,8

PACKAGING

L: 280 mm
D: 130 mm
H: 70 mm

0,5 kg



ARTICLE | ARTICOLO | ARTICLE

SH003



ABS multifunction handshower

Doccia ABS multifunzione

Douche ABS multifonctions

CODE / COEFFICIENT | CODICE /
COEFFICIENTE | CODE / COEFFICIENT

●	CC	SH003CC	1
---	----	---------	---

PACKAGING

L: 280 mm
D: 130 mm
H: 70 mm

0,7 kg

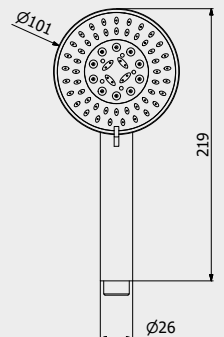

ARTICLE | ARTICOLO | ARTICLE

SH008



Square shower monojet SUMO
Doccetta quadra monogetto SUMO
Douchette carré à un jet SUMO

CODE / COEFFICIENT | CODICE /
COEFFICIENTE | CODE / COEFFICIENT

CC SH008CC 1

PACKAGING

L: 280 mm
D: 130 mm
H: 70 mm

0,7 kg

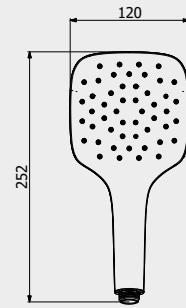

ARTICLE | ARTICOLO | ARTICLE

SH009



Square shower three jets SUMO
Doccetta quadra tre getti SUMO
Douchette carré à trois jets SUMO

CODE / COEFFICIENT | CODICE /
COEFFICIENTE | CODE / COEFFICIENT

CC SH009CC 1,2

PACKAGING

L: 280 mm
D: 130 mm
H: 70 mm

0,7 kg

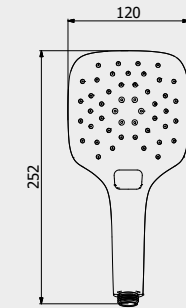

ARTICLE | ARTICOLO | ARTICLE

SH012



Round shower monojet CLEAN
Doccetta tonda monogetto CLEAN
Douchette ronde à un jet CLEAN

CODE / COEFFICIENT | CODICE /
COEFFICIENTE | CODE / COEFFICIENT

CC SH012CC 1

PACKAGING

L: 280 mm
D: 130 mm
H: 70 mm

0,7 kg

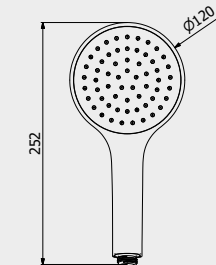

ARTICLE | ARTICOLO | ARTICLE

SH013



Round shower three jets CLEAN PLUS
Doccetta tonda tre getti CLEAN PLUS
Douchette ronde à trois jets CLEAN PLUS

CODE / COEFFICIENT | CODICE /
COEFFICIENTE | CODE / COEFFICIENT

CC SH013CC 1,2

PACKAGING

L: 280 mm
D: 130 mm
H: 70 mm

0,7 kg

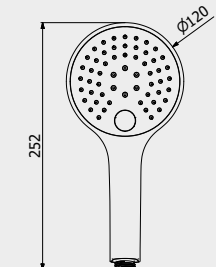

ARTICLE | ARTICOLO | ARTICLE

AA101



Round shower three jets CLEAN PLUS
Doccetta tonda tre getti CLEAN PLUS
Douchette ronde à trois jets CLEAN PLUS

CODE / COEFFICIENT | CODICE /
COEFFICIENTE | CODE / COEFFICIENT

CC AA101CC 1,8

PACKAGING

L: 280 mm
D: 130 mm
H: 70 mm

0,7 kg

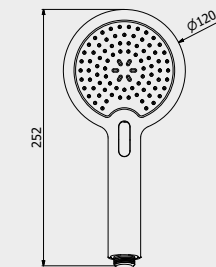

Duplex

Duplex
Duplex

ARTICLE | ARTICOLO | ARTICLE

SH022



Duplex round - Round

Duplex tondo - Tondo

Duplex rond - Rond

●	CC	SH022CC	3,1
●	SS	SH022SS	3,9
●	BO	SH022BO	3,7
●	NP	SH022NP	3,9
●	CF	SH022CF	4,7
●	CS	SH022CS	5,0
●	OO	SH022OO	4,7
●	II	SH022II	4,7
●	IS	SH022IS	5,0
●	RS	SH022RS	4,7
●	SR	SH022SR	5,0
●	OS	SH022OS	5,0
●	BB	SH022BB	4,3
●	RR	SH022RR	4,3
●	ON	SH022ON	3,1
●	PL	SH022PL	5,0

PACKAGING

L: 280 mm
D: 260 mm
H: 70 mm

1,0 kg

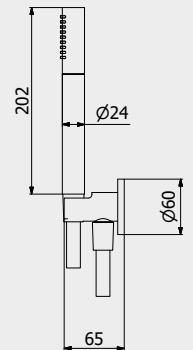

ARTICLE | ARTICOLO | ARTICLE

SH024



Duplex round - Square

Duplex tondo - Quadro

Duplex rond - Carré

●	CC	SH024CC	3,1
●	SS	SH024SS	3,9
●	BO	SH024BO	3,7
●	NP	SH024NP	3,9
●	CF	SH024CF	4,7
●	CS	SH024CS	5,0
●	OO	SH024OO	4,7
●	II	SH024II	4,7
●	IS	SH024IS	5,0
●	RS	SH024RS	4,7
●	SR	SH024SR	5,0
●	OS	SH024OS	5,0
●	BB	SH024BB	4,3
●	RR	SH024RR	4,3
●	ON	SH024ON	3,1
●	PL	SH024PL	5,0

PACKAGING

L: 280 mm
D: 260 mm
H: 70 mm

1,0 kg

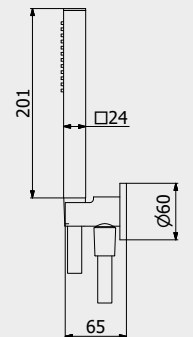

ARTICLE | ARTICOLO | ARTICLE

SH023



Duplex round - Multifunction

Duplex tondo - Multifunzione

Duplex rond - Multifonction

CODE / COEFFICIENT | CODICE /
COEFFICIENTE | CODE / COEFFICIENT

●	CC	SH023CC	3,1
---	----	---------	-----

PACKAGING

L: 280 mm
D: 260 mm
H: 70 mm

1,0 kg

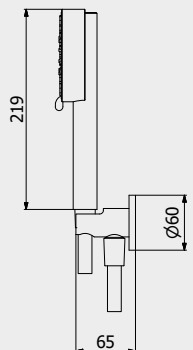

ARTICLE | ARTICOLO | ARTICLE

SH029



Duplex three jets SUMO
Duplex tre getti SUMO
Duplex à trois jets SUMO

CODE / COEFFICIENT | CODICE /
COEFFICIENTE | CODE / COEFFICIENT

CC SH029CC 3,1

PACKAGING

L: 280 mm
D: 260 mm
H: 70 mm

1,0 kg

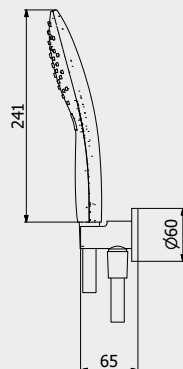

ARTICLE | ARTICOLO | ARTICLE

SH025



Duplex three jets CLEAN PLUS
Duplex tre getti CLEAN PLUS
Duplex à trois jets CLEAN PLUS

CODE / COEFFICIENT | CODICE /
COEFFICIENTE | CODE / COEFFICIENT

CC SH025CC 3,1

PACKAGING

L: 280 mm
D: 260 mm
H: 70 mm

1,0 kg

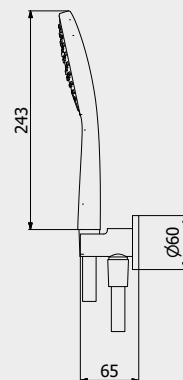

ARTICLE | ARTICOLO | ARTICLE

SH042



Duplex square
Duplex quadro
Duplex carré

- CC SH042CC 3,2
- SS SH042SS 4,0
- BO SH042BO 3,8
- NP SH042NP 4,0
- CF SH042CF 4,8
- CS SH042CS 5,1
- OO SH042OO 4,8
- II SH042II 4,8
- IS SH042IS 5,1
- RS SH042RS 4,8
- SR SH042SR 5,1
- OS SH042OS 5,1
- BB SH042BB 4,5
- RR SH042RR 4,5
- ON SH042ON 3,2
- PL SH042PL 5,1

PACKAGING

L: 280 mm
D: 130 mm
H: 70 mm

1,2 kg

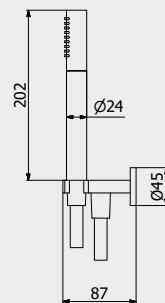

ARTICLE | ARTICOLO | ARTICLE

SH044



Duplex round - square
Duplex tondo - quadro
Duplex carré - Carré

- CC SH044CC 3,2
- SS SH044SS 4,0
- BO SH044BO 3,8
- NP SH044NP 4,0
- CF SH044CF 4,8
- CS SH044CS 5,1
- OO SH044OO 4,8
- II SH044II 4,8
- IS SH044IS 5,1
- RS SH044RS 4,8
- SR SH044SR 5,1
- OS SH044OS 5,1
- BB SH044BB 4,5
- RR SH044RR 4,5
- ON SH044ON 3,2
- PL SH044PL 5,1

PACKAGING

L: 280 mm
D: 130 mm
H: 70 mm

1,2 kg

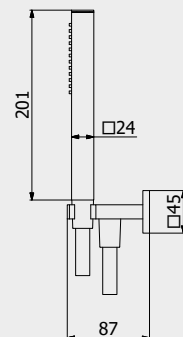

ARTICLE | ARTICOLO | ARTICLE

SH043

ABS



Duplex square - Multifunction
 Duplex quadro - Multifunzione
 Duplex carré - Multifonction

CODE / COEFFICIENT | CODICE /
 COEFFICIENTE | CODE / COEFFICIENT

CC SH043CC 3,1

PACKAGING

L: 280 mm
 D: 130 mm
 H: 70 mm

1,2 kg

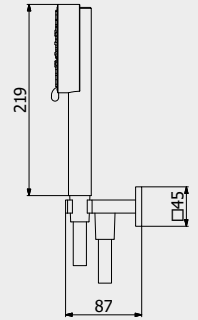

ARTICLE | ARTICOLO | ARTICLE

SH035

ABS



Duplex three jets SUMO
 Duplex tre getti SUMO
 Duplex à trois jets SUMO

CODE / COEFFICIENT | CODICE /
 COEFFICIENTE | CODE / COEFFICIENT

CC SH035CC 3,1

PACKAGING

L: 280 mm
 D: 130 mm
 H: 70 mm

1,2 kg

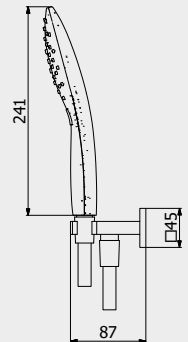

ARTICLE | ARTICOLO | ARTICLE

SH028

ABS



Duplex three jets CLEAN PLUS
 Duplex tre getti CLEAN PLUS
 Duplex à trois jets CLEAN PLUS

CODE / COEFFICIENT | CODICE /
 COEFFICIENTE | CODE / COEFFICIENT

CC SH028CC 3,1

PACKAGING

L: 280 mm
 D: 260 mm
 H: 70 mm

1,0 kg

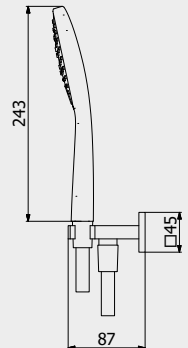

ARTICLE | ARTICOLO | ARTICLE

SH045

Pb



Duplex Belmondo
 Duplex Belmondo
 Duplex Belmondo

CODE / COEFFICIENT | CODICE /
 COEFFICIENTE | CODE / COEFFICIENT

CC SH045CC 6,1

OO SH045OO 9,1

II SH045II 9,1

RS SH045RS 9,1

PL SH045PL 9,8

PACKAGING

L: 280 mm
 D: 130 mm
 H: 70 mm

1,7 kg

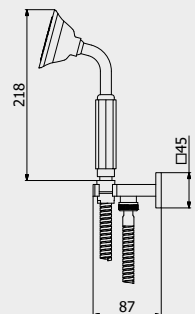

ARTICOLO | ARTICLE | ARTICLE

HR046



Duplex HERMES
Duplex HERMES
Duplex HERMES

CODICE / COEFFICIENTE CODICE / COEFFICIENTE		COEFFICIENTE CODE / COEFFICIENT
CC	HR046CC	4,0
PL	HR046PL	6,4
SS	HR046SS	5,0
II	HR046II	6,0
RS	HR046RS	6,0
OS	HR046OS	6,4
RR	HR046RR	5,6
BB	HR046BB	5,6

PACKAGING

L: 280 mm
D: 130 mm
H: 70 mm

 1,2 kg

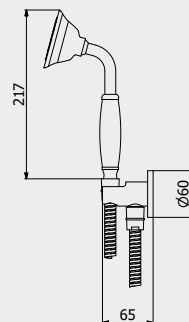

ARTICLE | ARTICOLO | ARTICLE

MR022



Duplex MARMO
Duplex MARMO
Duplex MARMO

CODE / COEFFICIENT CODICE / COEFFICIENTE		COEFFICIENTE CODE / COEFFICIENT
--	--	-----------------------------------

CC	MR022CC_1	MR022CC_2	8,6
PL	MR022PL_1	MR022PL_2	13,8
SS	MR022SS_1	MR022SS_2	10,8
ON	MR022ON_1	MR022ON_2	8,6
BO	MR022BO_1	MR022BO_2	10,3
NP	MR022NP_1	MR022NP_2	10,3
CF	MR022CF_1	MR022CF_2	12,9
CS	MR022CS_1	MR022CS_2	13,8
II	MR022II_1	MR022II_2	12,9
IS	MR022IS_1	MR022IS_2	13,8
RS	MR022RS_1	MR022RS_2	12,9
SR	MR022SR_1	MR022SR_2	13,8
OO	MR022OO_1	MR022OO_2	12,9
OS	MR022OS_1	MR022OS_2	13,8

PACKAGING

L: 360 mm
D: 220 mm
H: 150 mm

 1,8 kg

MARBLE

White Carrara
 Black Marquina

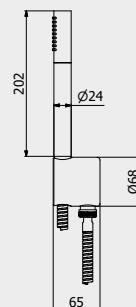

ARTICLE | ARTICOLO | ARTICLE

AA024



Duplex TAAAC
Duplex TAAAC
Duplex TAAAC

CODE / COEFFICIENT CODICE / COEFFICIENTE		COEFFICIENTE CODE / COEFFICIENT
CC	AA024CC	3,5
SS	AA024SS	4,4
BO	AA024BO	4,4
NP	AA024NP	4,4

PACKAGING

L: 265 mm
D: 260 mm
H: 70 mm

 1,4 kg

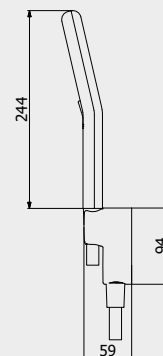

ARTICLE | ARTICOLO | ARTICLE

B2022



Duplex
Duplex
Duplex

CODE / COEFFICIENT CODICE / COEFFICIENTE		COEFFICIENTE CODE / COEFFICIENT
CC	B2022CC	6,3
SS	B2022SS	7,9
ON	B2022ON	6,3
NP	B2022NP	7,9
CF	B2022CF	9,5
CS	B2022CS	10,1
II	B2022II	9,5
IS	B2022IS	10,1
RS	B2022RS	9,5
SR	B2022SR	10,1
OO	B2022OO	9,5
OS	B2022OS	10,1

PACKAGING

L: 340 mm
D: 180 mm
H: 70 mm

 1,0 kg

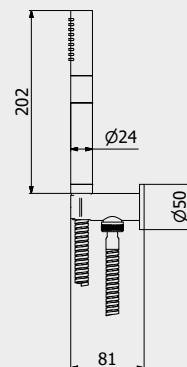

Shower & Co

Shower rail

Saliscendi
Loquets

ARTICLE | ARTICOLO | ARTICLE

SH100

ABS



Multifunction shower rail set

Saliscendi Multifunzione

Loquet multifonctions

CODE / COEFFICIENT | CODICE /
COEFFICIENTE | CODE / COEFFICIENT

● CC SH100CC 2,5

PACKAGING

📦 L: 810 mm
D: 430 mm
H: 465 mm

⚖️ 1,8 kg

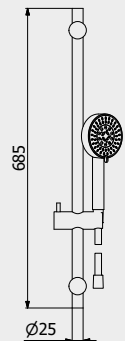

ARTICLE | ARTICOLO | ARTICLE

SH101

ABS



Multifunction shower rail with soap holder

Saliscendi Multifunzione con piatto porta sapone

Loquet multifonctions avec porte savon plat

CODE / COEFFICIENT | CODICE /
COEFFICIENTE | CODE / COEFFICIENT

● CC SH101CC 2,6

PACKAGING

📦 L: 810 mm
D: 430 mm
H: 465 mm

⚖️ 1,8 kg

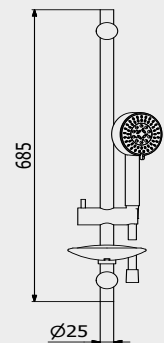

ARTICLE | ARTICOLO | ARTICLE

SH102

Pb



Hermes shower rail

Saliscendi Hermes

Loquet Hermes

● CC SH102CC 7,9

● SS SH102SS 9,9

● II SH102II 11,9

● RS SH102RS 11,9

● OS SH102OS 12,6

● BB SH102BB 11,1

● RR SH102RR 11,1

● PL SH102PL 12,6

PACKAGING

📦 L: 810 mm
D: 430 mm
H: 465 mm

⚖️ 1,8 kg

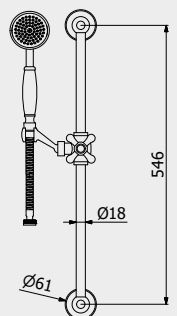

ARTICLE | ARTICOLO | ARTICLE

SH109

ABS



Shower rail three jets SUMO

Saliscendi tre getti SUMO

Loquet à trois jets SUMO

CODE / COEFFICIENT | CODICE /
COEFFICIENTE | CODE / COEFFICIENT

CC SH109CC 4,9

PACKAGING

L: 810 mm
D: 430 mm
H: 465 mm

1,8 kg

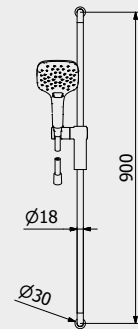

ARTICLE | ARTICOLO | ARTICLE

SH111

ABS



Shower rail three jets CLEAN PLUS

Saliscendi tre getti CLEAN PLUS

Loquet à trois jets CLEAN PLUS

CODE / COEFFICIENT | CODICE /
COEFFICIENTE | CODE / COEFFICIENT

CC SH111CC 4,8

PACKAGING

L: 810 mm
D: 430 mm
H: 465 mm

1,8 kg

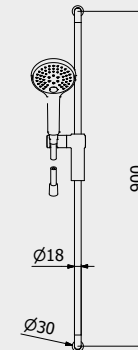

ARTICLE | ARTICOLO | ARTICLE

AA100

ABS



Shower rail TAAC

Saliscendi TAAAC

Loquet multifonctions TAAAC

CODE / COEFFICIENT | CODICE /
COEFFICIENTE | CODE / COEFFICIENT

CC AA100CC 6,3

SS AA100SS 7,9

PACKAGING

L: 965 mm
D: 175 mm
H: 195 mm

1,4 kg

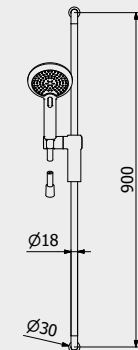

Shower
& Co

Bodyjet

Bodyjet
Bodyjet

ARTICLE | ARTICOLO | ARTICLE

SH030



Square Body - jet

Getto laterale quadro

Body - Jet carré

● CC	SH030CC	2
● SS	SH030SS	2,5
● BO	SH030BO	2,4
● NP	SH030NP	2,5
● CF	SH030CF	3,0
● CS	SH030CS	3,2
● OO	SH030OO	3,0
● II	SH030II	3,0
● IS	SH030IS	3,2
● RS	SH030RS	3,0
● SR	SH030SR	3,2
● OS	SH030OS	3,2
● BB	SH030BB	2,8
● RR	SH030RR	2,8
● ON	SH030ON	1,8
● PL	SH030PL	3,2

PACKAGING

L: 280 mm
D: 130 mm
H: 70 mm

0,2 kg

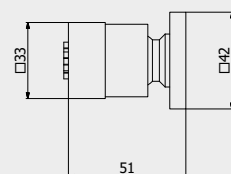

ARTICLE | ARTICOLO | ARTICLE

SH031



Round Body - jet

Getto laterale tondo

Body - Jet rond

● CC	SH031CC	1,4
● SS	SH031SS	1,8
● BO	SH031BO	1,7
● NP	SH031NP	1,8
● CF	SH031CF	2,1
● CS	SH031CS	2,2
● OO	SH031OO	2,1
● II	SH031II	2,1
● IS	SH031IS	2,2
● RS	SH031RS	2,1
● SR	SH031SR	2,2
● OS	SH031OS	2,2
● BB	SH031BB	2,0
● RR	SH031RR	2,0
● ON	SH031ON	2,8
● PL	SH031PL	2,2

PACKAGING

L: 280 mm
D: 130 mm
H: 70 mm

0,2 kg

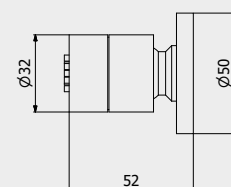

ARTICLE | ARTICOLO | ARTICLE

SH032



Hermes Body - jet

Getto laterale Hermes

Body - jet Hermes

● CC	SH032CC	1,5
● SS	SH032SS	1,9
● BO	SH032BO	1,8
● NP	SH032NP	1,9
● CF	SH032CF	2,3
● CS	SH032CS	2,4
● OO	SH032OO	2,3
● II	SH032II	2,3
● IS	SH032IS	2,4
● RS	SH032RS	2,3
● SR	SH032SR	2,4
● OS	SH032OS	2,4
● BB	SH032BB	2,1
● RR	SH032RR	2,1
● ON	SH032ON	3,8
● PL	SH032PL	2,4

PACKAGING

L: 280 mm
D: 130 mm
H: 70 mm

0,2 kg

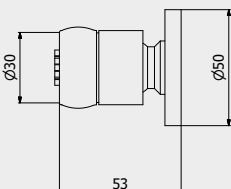

ARTICLE | ARTICOLO | ARTICLE

SH033



Square built-in Body - jet
 Getto laterale incasso quadro
 Body-Jet encastré carré

CODE / COEFFICIENT	CODICE / COEFFICIENTE	
CC	SH033CC	3,7

PACKAGING

L: 150 mm
 D: 190 mm
 H: 98 mm

0,8 kg

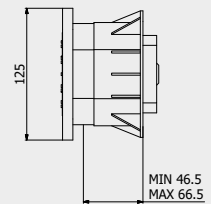

ARTICLE | ARTICOLO | ARTICLE

SH034



Round built-in Body - jet
 Getto laterale incasso tondo
 Body-Jet encastré rond

CODE / COEFFICIENT	CODICE / COEFFICIENTE	
CC	SH034CC	3,7

PACKAGING

L: 150 mm
 D: 190 mm
 H: 98 mm

0,8 kg

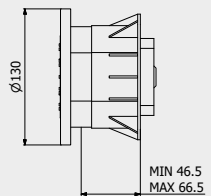

ARTICLE | ARTICOLO | ARTICLE

SH014



Round lateral Body - jet spray
 Getto laterale fisso tondo nebulizzatore
 Body-jet lateral rond pulverisation

CC	SH014CC	3,4
SS	SH014SS	4,3
BO	SH014BO	4,1
NP	SH014NP	4,3
CF	SH014CF	5,1
CS	SH014CS	5,4
OO	SH014OO	5,1
II	SH014II	5,1
IS	SH014IS	5,4
RS	SH014RS	5,1
SR	SH014SR	5,4
OS	SH014OS	5,4
BB	SH014BB	4,8
RR	SH014RR	4,8
ON	SH014ON	3,4
PL	SH014PL	5,4

PACKAGING

L: 280 mm
 D: 130 mm
 H: 70 mm

0,5 kg

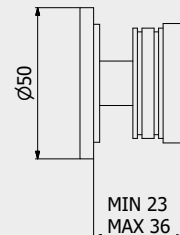

Shower & Co

Shut off

Idroscopini

Ensemble hygiénique

ARTICLE | ARTICOLO | ARTICLE

SH067



Metal shut off with chromolux flexible

Idroscopino metal con chromolux

Ensemble Hygiénique metal avec chromolux

●	CC	SH067CC	5,0
●	SS	SH067SS	6,3
●	BO	SH067BO	6,0
●	NP	SH067NP	6,3
●	CF	SH067CF	7,5
●	CS	SH067CS	8,0
●	OO	SH067OO	7,5
●	II	SH067II	7,5
●	IS	SH067IS	8,0
●	RS	SH067RS	7,5
●	SR	SH067SR	8,0
●	OS	SH067OS	8,0
●	BB	SH067BB	7,0
●	RR	SH067RR	7,0
●	ON	SH067ON	5,0
●	PL	SH067PL	8,0

PACKAGING

L: 150 mm
 D: 100 mm
 H: 60 mm

0,6 kg

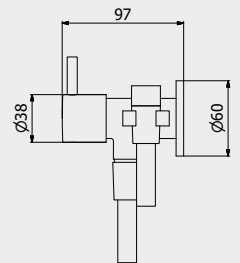

ARTICLE | ARTICOLO | ARTICLE

SH070



Easy shut off with long chromolux flexible

Idroscopino easy con flessibile doppia aggraffatura

Ensemble Hygiénique easy avec flexible

CODE / COEFFICIENTE | CODICE /
 COEFFICIENTE | CODE / COEFFICIENT

●	CC	SH070CC	0,7
---	----	---------	-----

PACKAGING

L: 280 mm
 D: 130 mm
 H: 70 mm

1,4 kg

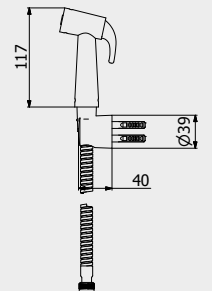

!



IN ORDER TO CONSULT THE BIDET SPRAYERS (CODE 706), PLEASE REFER TO EACH BATHROOM COLLECTION.
PER LA CONSULTAZIONE DEGLI IDROSCOPINI (CODICE 706) SI RIMANDA AD OGNI COLLEZIONE BAGNO
POUR LA CONSULTATION DES DOUCHETTES BIDET (CODE 706) FAIRE RÉFÉRENCE À CHAQUE COLLECTION DE BAIN.



Stop valves

Rubinetti d'arresto
Commandes d'arrêt

ARTICLE | ARTICOLO | ARTICLE

SH010



Round stop valves (two pieces)

Coppia rubinetti sottolavabo tondi

Paire de robinets ronds

CODE / COEFFICIENT | CODICE /
COEFFICIENTE | CODE / COEFFICIENT

CC	SH010CC	1,3
SS	SH010SS	1,6
BO	SH010BO	1,5
NP	SH010NP	1,6
CF	SH010CF	1,9
CS	SH010CS	2,0
OO	SH010OO	1,9
II	SH010II	1,9
IS	SH010IS	2,0
RS	SH010RS	1,9
SR	SH010SR	2,0
OS	SH010OS	2,0
BB	SH010BB	1,8
RR	SH010RR	1,8
ON	SH010ON	1,8
PL	SH010PL	2,0

PACKAGING

L: 280 mm
D: 130 mm
H: 70 mm

0,4 kg

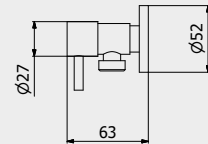

ARTICLE | ARTICOLO | ARTICLE

SH011



Square stop valves (two pieces)

Coppia rubinetti sottolavabo quadri

Paire de robinets carré

CODE / COEFFICIENT | CODICE /
COEFFICIENTE | CODE / COEFFICIENT

CC	SH011CC	1,5
----	---------	-----

PACKAGING

L: 280 mm
D: 130 mm
H: 70 mm

0,8 kg

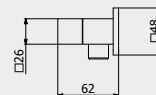

Water outlet

Prese d'acqua
Prise d'eau

ARTICLE | ARTICOLO | ARTICLE

SH060



Cilindrical water outlet

Pres a acqua tonda

Prise d'eau rond

●	CC	SH060CC	1,5
●	SS	SH060SS	1,9
●	BO	SH060BO	1,8
●	NP	SH060NP	1,9
●	CF	SH060CF	2,3
●	CS	SH060CS	2,4
●	OO	SH060OO	2,3
●	II	SH060II	2,3
●	IS	SH060IS	2,4
●	RS	SH060RS	2,3
●	SR	SH060SR	2,4
●	OS	SH060OS	2,4
●	BB	SH060BB	2,1
●	RR	SH060RR	2,1
●	ON	SH060ON	1,8
●	PL	SH060PL	2,4

PACKAGING

L: 150 mm
D: 100 mm
H: 60 mm

0,5 kg

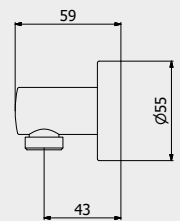

ARTICLE | ARTICOLO | ARTICLE

SH061



Square water outlet

Pres a acqua quadra

Prise d'eau carré

●	CC	SH061CC	2,5
●	SS	SH061SS	3,1
●	BO	SH061BO	3,0
●	NP	SH061NP	3,1
●	CF	SH061CF	3,8
●	CS	SH061CS	4,0
●	OO	SH061OO	3,8
●	II	SH061II	3,8
●	IS	SH061IS	4,0
●	RS	SH061RS	3,8
●	SR	SH061SR	4,0
●	OS	SH061OS	4,0
●	BB	SH061BB	3,5
●	RR	SH061RR	3,5
●	ON	SH061ON	2,8
●	PL	SH061PL	4,0

PACKAGING

L: 150 mm
D: 100 mm
H: 60 mm

0,5 kg

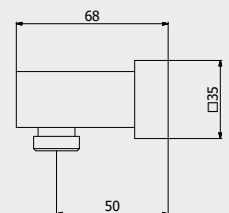

Bottle trap

Sifoni
Siphons

ARTICLE | ARTICOLO | ARTICLE

SH080



Round bottle trap

Sifone tondo

Siphon rond

● CC	SH080CC	4,5
● SS	SH080SS	5,6
● BO	SH080BO	5,4
● NP	SH080NP	5,6
● CF	SH080CF	6,8
● CS	SH080CS	7,2
● OO	SH080OO	6,8
● II	SH080II	6,8
● IS	SH080IS	7,2
● RS	SH080RS	6,8
● SR	SH080SR	7,2
● OS	SH080OS	7,2
● BB	SH080BB	6,3
● RR	SH080RR	6,3
● ON	SH080ON	4,5
● PL	SH080PL	7,2

PACKAGING

L: 340 mm
D: 180 mm
H: 70 mm

1,0 kg

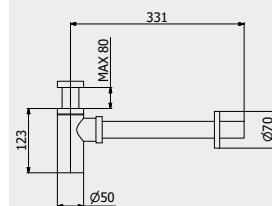

ARTICLE | ARTICOLO | ARTICLE

SH081



Square bottle trap

Sifone quadro

Siphon carré

● CC	SH081CC	4,7
● SS	SH081SS	5,9
● BO	SH081BO	5,6
● NP	SH081NP	5,9
● CF	SH081CF	7,1
● CS	SH081CS	7,5
● OO	SH081OO	7,1
● II	SH081II	7,1
● IS	SH081IS	7,5
● RS	SH081RS	7,1
● SR	SH081SR	7,5
● OS	SH081OS	7,5
● BB	SH081BB	6,6
● RR	SH081RR	6,6
● ON	SH081ON	4,7
● PL	SH081PL	7,5

PACKAGING

L: 340 mm
D: 180 mm
H: 70 mm

1,0 kg

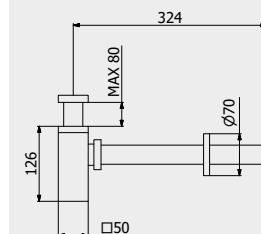

ARTICLE | ARTICOLO | ARTICLE

SH082



EASY bottle trap

Sifone EASY

Siphon EASY

CODE / COEFFICIENT | CODICE /
COEFFICIENTE | CODE / COEFFICIENT

● CC	SH082CC	1,5
------	---------	-----

PACKAGING

L: 340 mm
D: 180 mm
H: 70 mm

0,9 kg

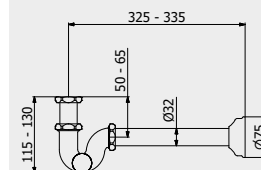

Shower
& Co



Interactive PDF, you can view the collection directly by clicking on it.
PDF interattivo, per visualizzare direttamente la collezione basta cliccarci sopra.
PDF interactif, vous pouvez voir la collection directement en cliquant dessus.



ACCIAIO
P. 668



LOFT
P. 676



KITCHEN
P. 682

KC

**KITCHEN
CUCINA
CUISINE**

ACCIAIO

The form becomes an emblem for high professionalism.

La forma si fa simbolo di alta professionalità ed efficienza.
La forme devient emblème de haut professionnalisme

The ACCIAIO collection draws inspiration from a linear aesthetics and an innovative technology, blending together just like in a professional kitchen.

The clean and modern form, elegant in its sobriety, is nothing but the mirror of a all-round technological product, consisting of pull-out hand shower, moving spring and complete rotation, which guarantee the best procedures in an elegant and sophisticated environment, where the form becomes an emblem for high professionalism and efficiency.

La collezione ACCIAIO si ispira alla fusione tra un'estetica lineare e una tecnologia innovativa, tipica delle migliori cucine professionali. La pulizia e modernità della forma, elegante nella sua sobrietà, non è altro che lo specchio di un prodotto completo e tecnologico, composto da doccetta estraibile, molla di movimento e da una rotazione completa, per garantire le migliori pratiche in un ambiente dall'elegante tocco estetico, in cui la forma si fa simbolo di alta professionalità ed efficienza.

La collection ACCIAIO s'inspire de la fusion entre une esthétique linéaire et une technologie innovante, typique des meilleures cuisines professionnelles. La pureté et modernité de la forme, élégante dans sa sobriété, n'est que le miroir d'un produit hautement technologique, composé d'une douchette extractible, d'un ressort de mouvement et d'une rotation complète, qui garantit les meilleures pratiques dans un environnement à la touche esthétique raffinée, où la forme devient emblème de haut professionnalisme et efficacité.



LEAD FREE



ZINC FREE



ROTATING









← AC386
Lateral lever spring sink mixer
Lavello leva laterale con molla
Évier de cuisine à ressort et levier latéral

↑ AC381
Lateral lever and extractible shower sink mixer
Lavello Monoforo doccetta estraibile leva laterale
Évier de cuisine avec douchette extractible et levier latéral



Acciaio



↑ AC385
→ Lateral lever sink mixer
Lavello leva laterale
Évier de cuisine avec levier latéral

↙ AC382
Lateral lever and extractible shower sink mixer
Lavello Monoforo doccetta estraibile leva laterale
Évier de cuisine avec douchette extractible et levier latéral





ARTICLE | ARTICOLO | ARTICLE

AC381



Lateral lever and extractible shower sink mixer
 Lavello Monoforo doccetta estraibile leva laterale
 Évier de cuisine avec douchette extractible et levier latéral

CODICE / COEFFICIENTE | CODICE / COEFFICIENTE
 SS AC381SS 25,5

PACKAGING

L: 685 mm
 D: 345 mm
 H: 168 mm

3,0 kg

NB: Faucet entirely in stainless steel /
 Rubinetto interamente in acciaio
 inossidabile / Robinet tout en
 acier inoxydable

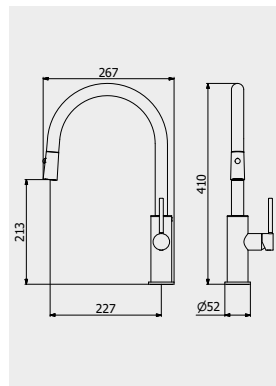

PORTATE WATER FLOW DÉBIT D'EAU		
1 BAR	2 BAR	3 BAR
6 l/m	7,5 l/m	9,5 l/m

ARTICLE | ARTICOLO | ARTICLE

AC382



Lateral lever and extractible shower sink mixer
 Lavello Monoforo doccetta estraibile leva laterale
 Évier de cuisine avec douchette extractible et levier latéral

CODICE / COEFFICIENTE | CODICE / COEFFICIENTE
 SS AC382SS 25,1

PACKAGING

L: 685 mm
 D: 345 mm
 H: 168 mm

2,7 kg

NB: Faucet entirely in stainless steel /
 Rubinetto interamente in acciaio
 inossidabile / Robinet tout en
 acier inoxydable

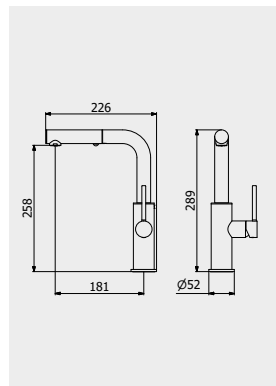

PORTATE WATER FLOW DÉBIT D'EAU		
1 BAR	2 BAR	3 BAR
6 l/m	7,5 l/m	9,5 l/m

ARTICLE | ARTICOLO | ARTICLE

AC385



Lateral lever sink mixer
 Lavello leva laterale
 Évier de cuisine avec levier latéral

CODICE / COEFFICIENTE | CODICE / COEFFICIENTE
 SS AC385SS 20,2

PACKAGING

L: 685 mm
 D: 345 mm
 H: 168 mm

2,8 kg

NB: Faucet entirely in stainless steel /
 Rubinetto interamente in acciaio
 inossidabile / Robinet tout en
 acier inoxydable

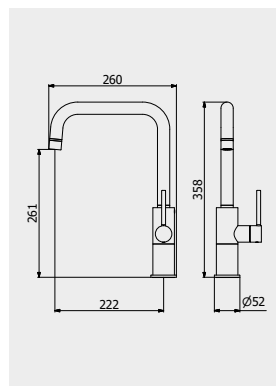

PORTATE WATER FLOW DÉBIT D'EAU		
1 BAR	2 BAR	3 BAR
6 l/m	7,5 l/m	9,5 l/m

ARTICLE | ARTICOLO | ARTICLE

AC386



Lateral lever spring sink mixer
 Lavello leva laterale con molla
 Évier de cuisine à ressort et levier latéral

CODICE / COEFFICIENTE | CODICE / COEFFICIENTE
 SS AC386SS 28,5

PACKAGING

L: 685 mm
 D: 345 mm
 H: 168 mm

3,4 kg

NB: Faucet entirely in stainless steel /
 Rubinetto interamente in acciaio
 inossidabile / Robinet tout en
 acier inoxydable

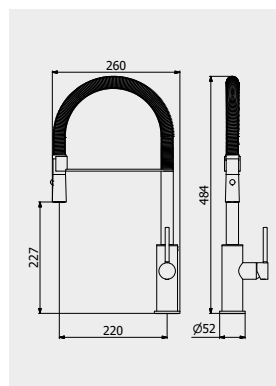

PORTATE WATER FLOW DÉBIT D'EAU		
1 BAR	2 BAR	3 BAR
6 l/m	7,5 l/m	9,5 l/m

Acciaio

LOFT

The boundless modern kitchen style.

Lo stile della cucina moderna senza confini.
Le style de cuisine moderne sans bornes.

Wide open rooms, clean and elegant lines, the modern style of bright and boundless spaces: LOFT collection draws inspiration from the elegant lofts of contemporary cities, reinterpreted in the form of kitchen faucets with a modern and sophisticated look. The avant-garde technology, which includes pull-out hand shower, moving spring and complete rotation, matches with a linear and elegant look and with chromed finishes, adding even more refinement to this high-class product.

Gli ampi spazi aperti, le linee pulite ed eleganti, lo stile moderno di uno spazio luminoso e senza limiti: la collezione LOFT trae ispirazione dalle eleganti abitazioni delle città moderne, reinterprete nella forma di rubinetti per cucina dall'aspetto moderno e ricercato. La tecnologia d'avanguardia, che include doccetta estraibile, molla di movimento e rotazione completa, è appaiata a un'estetica lineare ed elegante, completa di finiture cromate che aggiungono un'ancora maggiore ricercatezza a questo prodotto di alta classe.

Les grands espaces, les lignes pures et élégantes, le style moderne d'un milieu lumineux et illimité: la collection LOFT s'inspire des élégantes demeures de la ville moderne, pour les réinterpréter sous forme de robinets de cuisine aux traits modernes et sophistiqués. La technologie d'avant-garde, composée par une douchette extractible, un ressort de mouvement et une rotation complète, est associée à une esthétique linéaire et élégante, complétée par des finitions chromées qui ajoutent encore plus de raffinement à ce produit haut de gamme.



LEAD FREE



ZINC FREE



ROTATING









← L0386
Lateral lever spring sink mixer
Lavello leva laterale con molla
Évier de cuisine à ressort et levier latéral

↑ L0381
Lateral lever and extractible shower sink mixer
Lavello Monoforo doccetta estraibile leva laterale
Évier de cuisine avec douchette extractible et levier latéral

→ L0382
Lateral lever and extractible shower sink mixer
Lavello Monoforo doccetta estraibile leva laterale
Évier de cuisine avec douchette extractible et levier latéral





ARTICLE | ARTICOLO | ARTICLE

LO381



Lateral lever and extractable shower sink mixer

Lavello Monoforo doccetta estraibile leva laterale

Évier de cuisine avec douchette extractible et levier latéral

CODE / COEFFICIENT | CODICE /
COEFFICIENTE | CODE / COEFFICIENT

SS LO381SS 16,8

PACKAGING

L: 675 mm
D: 320 mm
H: 80 mm

3,6 kg

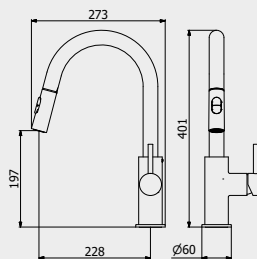

PORTATE | WATER FLOW | DÉBIT D'EAU

1 BAR	2 BAR	3 BAR
3 l/m	4,4 l/m	4,5 l/m

ARTICLE | ARTICOLO | ARTICLE

LO382



Lateral lever and extractable shower sink mixer

Lavello Monoforo doccetta estraibile leva laterale

Évier de cuisine avec douchette extractible et levier latéral

CODE / COEFFICIENT | CODICE /
COEFFICIENTE | CODE / COEFFICIENT

SS LO382SS 7,1

PACKAGING

L: 675 mm
D: 320 mm
H: 80 mm

2,3 kg

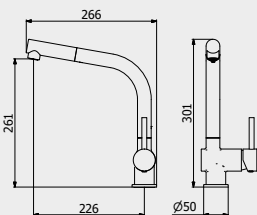

PORTATE | WATER FLOW | DÉBIT D'EAU

1 BAR	2 BAR	3 BAR
3 l/m	4,4 l/m	4,5 l/m

ARTICLE | ARTICOLO | ARTICLE

LO386



Lateral lever spring sink mixer

Lavello leva laterale con molla

Évier de cuisine à ressort et levier latéral

CODE / COEFFICIENT | CODICE /
COEFFICIENTE | CODE / COEFFICIENT

SS LO386SS 21,0

PACKAGING

L: 675 mm
D: 320 mm
H: 80 mm

4,2 kg

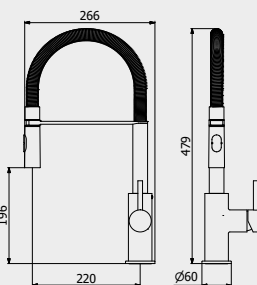

PORTATE | WATER FLOW | DÉBIT D'EAU

1 BAR	2 BAR	3 BAR
3 l/m	4,4 l/m	4,5 l/m

KITCHEN

One for all or all for one.

Uno per tutti o tutti per uno.
Un pour tous ou tous pour un.

If you are looking for harmony and continuity in your home, the KITCHEN collection is what you need. KITCHEN reproduces the best IB Bathroom faucet collections' aesthetics, in a version functionally and aesthetically updated to your kitchen, guaranteeing a home always coordinated and efficient, able to balance aesthetic and practical continuity, harmony and proportion in every room of your home.

Se ricerchi armonia e continuità nel tuo spazio casalingo, la collezione KITCHEN è quella adatta alla tua cucina. Kitchen ripropone l'estetica delle migliori collezioni IB Rubinetti per bagno, in una versione adattata alla funzionalità e all'estetica della cucina, per garantire una casa sempre coordinata ed efficiente, in un rapporto di continuità estetica e pratica che garantirà equilibrio, sintonia e proporzione in ogni ambiente della tua abitazione.

Si vous recherchez l'harmonie et la continuité dans votre milieu domestique, la collection KITCHEN est celle qui convient à votre cuisine. Kitchen reproduit l'esthétique des meilleures collections pour salle de bains de IB Rubinetti, dans une version adaptée aux fonctions et à l'esthétique de la cuisine, pour une maison toujours coordonnée et efficiente, dans une relation de continuité esthétique et pratique qui garantira équilibre, harmonie et proportion dans chaque pièce de votre maison.



LEAD FREE



ZINC FREE



ROTATING





ARTICLE | ARTICOLO | ARTICLE

HR371



Dual Control Kitchen Mixer

Lavello monoforo con due leve

Évier de cuisine

CODICE / COEFFICIENTE	CODE / COEFFICIENT	
CC	HR371CC	9,2
PL	HR371PL	14,7
SS	HR371SS	11,5
II	HR371II	13,8
RS	HR371RS	13,8
OS	HR371OS	14,7
RR	HR371RR	12,9

PACKAGING

L: 370 mm
D: 270 mm
H: 80 mm

2,6 kg

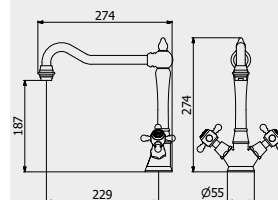

PORTATE | WATER FLOW | DÉBIT D'EAU

1 BAR	2 BAR	3 BAR
9,5 l/m	11 l/m	15 l/m

ARTICLE | ARTICOLO | ARTICLE

HR373



Dual control Wall mounted kitchen mixer

Lavello a parete con due leve

Évier de cuisine encastré au mur

CODICE / COEFFICIENTE	CODE / COEFFICIENT	
CC	HR373CC	7,4
PL	HR373PL	11,8
SS	HR373SS	9,3
II	HR373II	11,1
RS	HR373RS	11,1
OS	HR373OS	11,8
RR	HR373RR	10,4
BB	HR373BB	10,4

PACKAGING

L: 425 mm
D: 188 mm
H: 98 mm

1,8 kg

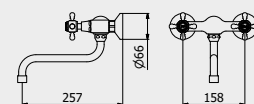

PORTATE | WATER FLOW | DÉBIT D'EAU

1 BAR	2 BAR	3 BAR
10 l/m	15 l/m	18 l/m

ARTICLE | ARTICOLO | ARTICLE

HL371



Dual Control Kitchen Mixer

Lavello monoforo con due leve

Évier de cuisine

CODICE / COEFFICIENTE	CODE / COEFFICIENT	CODE / COEFFICIENT		
CC	HL371CC_1	HL371CC_2	HL371CC_3	9,2
PL	HL371PL_1	HL371PL_2	HL371PL_3	14,7
SS	HL371SS_1	HL371SS_2	HL371SS_3	11,5
II	HL371II_1	HL371II_2	HL371II_3	13,8
RS	HL371RS_1	HL371RS_2	HL371RS_3	13,8
OS	HL371OS_1	HL371OS_2	HL371OS_3	14,7
RR	HL371RR_1	HL371RR_2	HL371RR_3	12,9

PACKAGING

L: 370 mm D: 270 mm H: 80 mm

2,6 kg

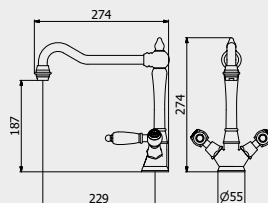

PORTATE | WATER FLOW | DÉBIT D'EAU

1 BAR	2 BAR	3 BAR
9,5 l/m	11 l/m	15 l/m

ARTICLE | ARTICOLO | ARTICLE

HL373



Dual control Wall mounted kitchen mixer

Lavello a parete con due leve

Évier de cuisine encastré au mur

CODICE / COEFFICIENTE	CODE / COEFFICIENT	CODE / COEFFICIENT		
CC	HL373CC_1	HL373CC_2	HL373CC_3	7,4
PL	HL373PL_1	HL373PL_2	HL373PL_3	11,8
SS	HL373SS_1	HL373SS_2	HL373SS_3	9,3
II	HL373II_1	HL373II_2	HL373II_3	11,1
RS	HL373RS_1	HL373RS_2	HL373RS_3	11,1
OS	HL373OS_1	HL373OS_2	HL373OS_3	11,8
RR	HL373RR_1	HL373RR_2	HL373RR_3	10,4
BB	HL373BB_1	HL373BB_2	HL373BB_3	10,4

PACKAGING

L: 425 mm D: 188 mm H: 98 mm

1,8 kg

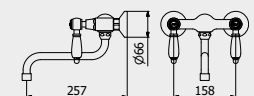

PORTATE | WATER FLOW | DÉBIT D'EAU

1 BAR	2 BAR	3 BAR
10 l/m	15 l/m	18 l/m



ARTICLE | ARTICOLO | ARTICLE

WI415



Under-window sink mixer with reed pipe

Lavello sotto-finestra con canna a tubo

Évier de cuisine dessous fenêtre avec bec rabattable

CODICE / COEFFICIENTE CODE / COEFFICIENT		
COEFFICIENT	CODE	COEFFICIENT
CC	WI415CC	10,1
SS	WI415SS	12,6
RR	WI415RR	14,1
BB	WI415BB	14,1

PACKAGING

L: 455 mm
 D: 310 mm
 H: 75 mm

 3,1 kg

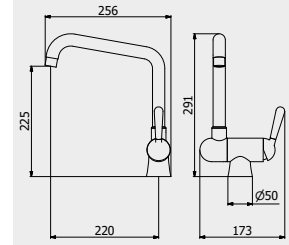

PORTATE | WATER FLOW | DÉBIT D'EAU

1 BAR	2 BAR	3 BAR
3 l/m	4,4 l/m	4,5 l/m

ARTICLE | ARTICOLO | ARTICLE

WI416



Under-window sink mixer with cast spout

Lavello sotto-finestra con canna fusa

Évier de cuisine dessous fenêtre avec bec rabattable

CODICE / COEFFICIENTE CODE / COEFFICIENT		
COEFFICIENT	CODE	COEFFICIENT
CC	WI416CC	8,5
SS	WI416SS	10,6
RR	WI416RR	11,9
BB	WI416BB	11,9

PACKAGING

L: 580 mm
 D: 370 mm
 H: 75 mm

 3,1 kg

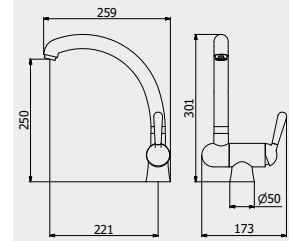

PORTATE | WATER FLOW | DÉBIT D'EAU

1 BAR	2 BAR	3 BAR
3 l/m	4,4 l/m	4,5 l/m

ARTICLE | ARTICOLO | ARTICLE

WI417



Under-window sink mixer with cane classic

Lavello sotto-finestra con canna classico

Évier de cuisine dessous fenêtre avec bec rabattable

CODICE / COEFFICIENTE CODE / COEFFICIENT		
COEFFICIENT	CODE	COEFFICIENT
CC	WI417CC	10,6
SS	WI417SS	13,3
RR	WI417RR	14,8
BB	WI417BB	14,8

PACKAGING

L: 455 mm
 D: 310 mm
 H: 75 mm

 3,3 kg

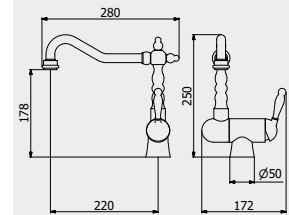

PORTATE | WATER FLOW | DÉBIT D'EAU

1 BAR	2 BAR	3 BAR
3 l/m	4,4 l/m	4,5 l/m

ARTICLE | ARTICOLO | ARTICLE

AT370



Sink mixer

Lavello Monoforo Miscelatore

Évier de cuisine

**CODICE / COEFFICIENTE | CODICE /
COEFFICIENTE | CODE / COEFFICIENT**

● CC	AT370CC	12,4
● SS	AT370SS	15,5

PACKAGING

 L: 225 mm
D: 95 mm
H: 70 mm

3,9 kg

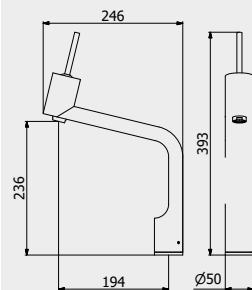

PORTATE | WATER FLOW | DÉBIT D'EAU

1 BAR	2 BAR	3 BAR
3 l/m	4,4 l/m	4,5 l/m

ARTICLE | ARTICOLO | ARTICLE

BI370



Sink mixer

Lavello Monoforo Miscelatore

Évier de cuisine

**CODICE / COEFFICIENTE | CODICE /
COEFFICIENTE | CODE / COEFFICIENT**

● CC	BI370CC	10,8
● SS	BI370SS	13,5
● BO	BI370BO	13,0
● NP	BI370NP	13,0
● CF	BI370CF	16,2
● CS	BI370CS	17,3
● II	BI370II	16,2
● IS	BI370IS	17,3
● RS	BI370RS	16,2
● SR	BI370SR	17,3
● OO	BI370OO	16,2
● OS	BI370OS	17,3

PACKAGING

 L: 425 mm
D: 188 mm
H: 98 mm

2,7 kg

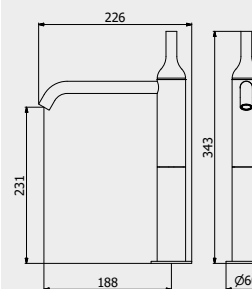

PORTATE | WATER FLOW | DÉBIT D'EAU

1 BAR	2 BAR	3 BAR
9,25 l/m	13,35 l/m	16,6 l/m

ARTICLE | ARTICOLO | ARTICLE

HJ370



Single Lever kitchen mixer

Lavello Monoforo Miscelatore

Évier de cuisine

**CODICE / COEFFICIENTE | CODICE /
COEFFICIENTE | CODE / COEFFICIENT**

● CC	HJ370CC	14,0
● SS	HJ370SS	17,5
● NP	HJ370NP	16,8

PACKAGING

 L: 455 mm
D: 310 mm
H: 75 mm

3,4 kg

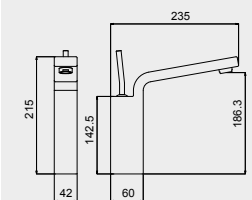

PORTATE | WATER FLOW | DÉBIT D'EAU

1 BAR	2 BAR	3 BAR
21,5 l/m	30 l/m	38 l/m

ARTICLE | ARTICOLO | ARTICLE

B1370



Single Lever kitchen mixer

Miscelatore lavello monoforo

Évier de cuisine

**CODICE / COEFFICIENTE | CODICE /
COEFFICIENTE | CODE / COEFFICIENT**

● CC	B1370CC	14
● SS	B1370SS	17,5
● ON	B1370ON	14,0
● NP	B1370NP	16,8
● CF	B1370CF	21,0
● CS	B1370CS	22,4
● II	B1370II	21,0
● IS	B1370IS	22,4
● RS	B1370RS	21,0
● SR	B1370SR	22,4
● OO	B1370OO	21,0
● OS	B1370OS	22,4

PACKAGING

 L: 400 mm
D: 250 mm
H: 140 mm

3,5 kg

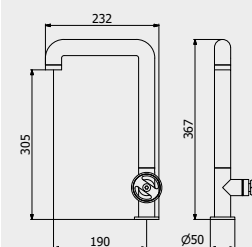

PORTATE | WATER FLOW | DÉBIT D'EAU

1 BAR	2 BAR	3 BAR
3 l/m	4,4 l/m	4,5 l/m



ARTICLE | ARTICOLO | ARTICLE

B2370



Single Lever kitchen mixer
Miscelatore lavello monoforo
Évier de cuisine

CODE / COEFFICIENT	CODICE / COEFFICIENTE	CODE / COEFFICIENT
CC	B2370CC	14
SS	B2370SS	17,5
ON	B2370ON	14,0
NP	B2370NP	16,8
CF	B2370CF	21,0
CS	B2370CS	22,4
II	B2370II	21,0
IS	B2370IS	22,4
RS	B2370RS	21,0
SR	B2370SR	22,4
OO	B2370OO	21,0
OS	B2370OS	22,4
6 LEVA ROSSA RED LEVER LEVIER ROUGE + 0,1		

PACKAGING

L: 400 mm
D: 250 mm
H: 140 mm

 3,5 kg

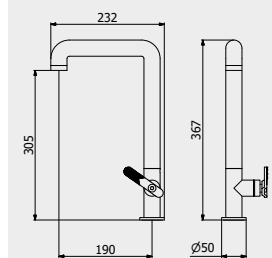

PORTATE | WATER FLOW | DÉBIT D'EAU

1 BAR	2 BAR	3 BAR
3 l/m	4,4 l/m	4,5 l/m

ARTICLE | ARTICOLO | ARTICLE

KS370



Single Lever kitchen mixer
Lavello Monoforo Miscelatore
Évier de cuisine

CODE / COEFFICIENT	CODICE / COEFFICIENTE	CODE / COEFFICIENT
CC	KS370CC	9,9
SS	KS370SS	12,4
NP	KS370NP	11,9

PACKAGING

L: 455 mm
D: 310 mm
H: 75 mm

 3,6 kg

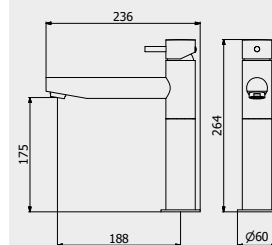

PORTATE | WATER FLOW | DÉBIT D'EAU

1 BAR	2 BAR	3 BAR
9 l/m	13 l/m	16 l/m

ARTICLE | ARTICOLO | ARTICLE

KS385



Side lever kitchen mixer
Miscelatore lavello monoforo con leva laterale
Évier de cuisine avec levier latéral

CODE / COEFFICIENT	CODICE / COEFFICIENTE	CODE / COEFFICIENT
CC	KS385CC	7,4
SS	KS385SS	9,3
NP	KS385NP	8,9

PACKAGING

L: 370 mm
D: 270 mm
H: 80 mm

 2,5 kg

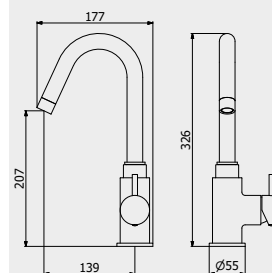

PORTATE | WATER FLOW | DÉBIT D'EAU

1 BAR	2 BAR	3 BAR
9 l/m	12,5 l/m	15 l/m

ARTICLE | ARTICOLO | ARTICLE

KU370



Single Lever kitchen mixer
Lavello Monoforo Miscelatore
Évier de cuisine

CODE / COEFFICIENT	CODICE / COEFFICIENTE	CODE / COEFFICIENT
CC	KU370CC	9,9
SS	KU370SS	12,4
NP	KU370NP	11,9

PACKAGING

L: 455 mm
D: 310 mm
H: 75 mm

 3,6 kg

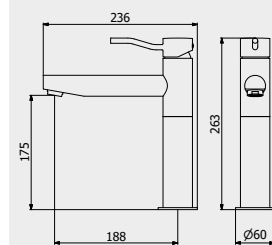

PORTATE | WATER FLOW | DÉBIT D'EAU

1 BAR	2 BAR	3 BAR
3 l/m	4,4 l/m	4,5 l/m

ARTICLE | ARTICOLO | ARTICLE

KU385



Side lever kitchen mixer

Miscelatore lavello monoforo con leva laterale

Évier de cuisine avec levier latéral

CODICE / COEFFICIENTE | CODICE /
COEFFICIENTE | CODE / COEFFICIENT

●	CC	KU385CC	7,4
●	SS	KU385SS	9,3
●	NP	KU385NP	8,9

PACKAGING

L: 370 mm
 D: 270 mm
 H: 80 mm

2,5 kg

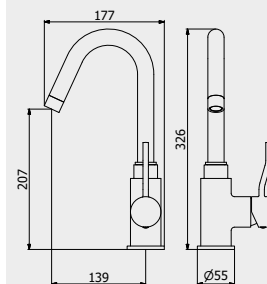

PORTATE | WATER FLOW | DÉBIT D'EAU

1 BAR	2 BAR	3 BAR
9 l/m	12,5 l/m	15 l/m

ARTICLE | ARTICOLO | ARTICLE

MT370



Single Lever kitchen mixer

Miscelatore lavello monoforo

Évier de cuisine

CODICE / COEFFICIENTE | CODICE /
COEFFICIENTE | CODE / COEFFICIENT

●	CC	MT370CC	9,6
●	SS	MT370SS	12,0
●	ON	MT370ON	9,6
●	BO	MT370BO	11,5
●	NP	MT370NP	11,5
●	CF	MT370CF	14,4
●	CS	MT370CS	15,4
●	II	MT370II	14,4
●	IS	MT370IS	15,4
●	RS	MT370RS	14,4
●	SR	MT370SR	15,4
●	OO	MT370OO	14,4
●	OS	MT370OS	15,4

PACKAGING

L: 455 mm
 D: 310 mm
 H: 75 mm

2,6 kg

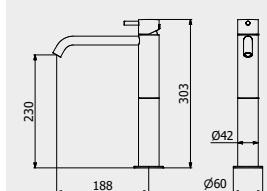

PORTATE | WATER FLOW | DÉBIT D'EAU

1 BAR	2 BAR	3 BAR
6,35 l/m	2,89 l/m	10,9 l/m

ARTICLE | ARTICOLO | ARTICLE

SB370



Sink mixer

Lavello Monoforo Miscelatore

Évier de cuisine

CODICE / COEFFICIENTE | CODE /
COEFFICIENTE | CODE / COEFFICIENT

●	CC	SB370CC	12,8
●	SS	SB370SS	16,0
●	NP	SB370NP	15,4
●	OS	SB370OS	20,5
●	RS	SB370RS	19,2
●	ON	SB370ON	12,8

PACKAGING

L: 400 mm
 D: 250 mm
 H: 140 mm

2,8 kg

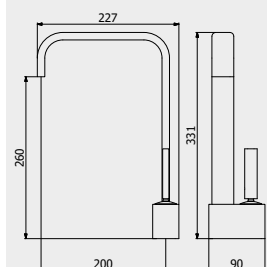

PORTATE | WATER FLOW | DÉBIT D'EAU

1 BAR	2 BAR	3 BAR
10 l/m	14 l/m	17 l/m

ARTICLE | ARTICOLO | ARTICLE

UN370



Sink mixer

Lavello Monoforo Miscelatore

Évier de cuisine

CODICE / COEFFICIENTE | CODE /
COEFFICIENTE | CODE / COEFFICIENT

●	CC	UN370CC	8,5
●	II	UN370II	12,8
●	BB	UN370BB	11,1
●	RR	UN370RR	11,1

PACKAGING

L: 225 mm
 D: 95 mm
 H: 70 mm

2,2 kg

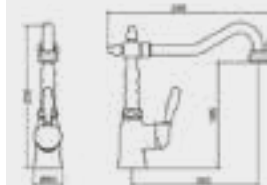

PORTATE | WATER FLOW | DÉBIT D'EAU

1 BAR	2 BAR	3 BAR
3 l/m	4,4 l/m	4,5 l/m



ARTICLE | ARTICOLO | ARTICLE

ID370



Single Lever kitchen mixer
Lavello Monoforo Miscelatore
Évier de cuisine

CODE / COEFFICIENT | CODICE / COEFFICIENTE | CODE / COEFFICIENT

BODY | CORPO | CORPS

LEVER | LEVA | LEVIER



+



●	CC	ID370CC	9,3
●	SS	ID370SS	14,0
●	ON	ID3700N	9,3
●	NP	ID3700NP	11,2
●	CF	ID370CF	14,0
●	CS	ID370CS	14,9
●	II	ID370II	14,0
●	IS	ID370IS	14,9
●	RS	ID370RS	14,0
●	SR	ID370SR	14,9
●	OO	ID370OO	14,0
●	OS	ID370OS	14,9



●	CC	_1	1,1
●	SS	_14	1,7
●	ON	_10	1,1
●	NP	_13	1,4
●	CF	_3	1,7
●	CS	_4	1,8
●	II	_8	1,7
●	IS	_9	1,8
●	RS	_7	1,7
●	SR	_14	1,8
●	OO	_5	1,7
●	OS	_9	1,8

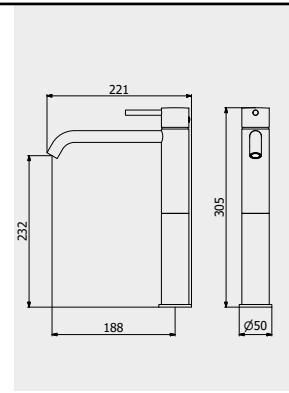

PORTATE | WATER FLOW | DÉBIT D'EAU

1 BAR	2 BAR	3 BAR
5,5 l/m	7,5 l/m	9,1 l/m

PACKAGING

L: 455 mm
D: 310 mm
H: 75 mm

2,7 kg

SPARE PARTS

LEGEND | LEGENDA | LÉGENDE

A Aerator Basin Kit Kit Aeratore lavabo Kit Mousseur lavabo	H Headwork Vitone Tête céramique
F Flex Flessibile Tuyau	D Deviator Deviatore Déviateur
C Cartridge Cartuccia Cartouche	V Valve Valvola Clapet

BOLD ROUND / LEVEL

ARTICLE ARTICOLO ARTICLE	DESCRIPTION DESCRIZIONE DESCRIPTION	BY MODEL PER MODELLO PAR MODÈLE	COEFFICIENT COEFFICIENTE COEFFICIENT
A AQ0015355	Aerator basin kit M24x1 Kit aeratore M24x1 Kit mousseur M24x1	200 202 206 209 306 390 392	0,6
F AQ0011013	Flex G3/8" L450 Flessibile G3/8" L450 Tuyau G3/8" L450	200 202 209 306 390 392	1,1
C AQ0015157	Cartridge Ø25 Cartuccia Ø25 Cartouche Ø25	200 202	1,6
H AQ0010529 AQ0010528	Headwork G1/2" Vitone G1/2" Tête céramique G1/2"	306 390 392	1,8
C AQ0004095	Cartridge Ø35 Cartuccia Ø35 Cartouche Ø35	206	1,0

MARMO / MARMO ELLE

ARTICLE ARTICOLO ARTICLE	DESCRIPTION DESCRIZIONE DESCRIPTION	BY MODEL PER MODELLO PAR MODÈLE	COEFFICIENT COEFFICIENTE COEFFICIENT
A AQ0015104	Aerator basin kit M16,5x1 Kit aeratore M16,5x1 Kit mousseur M16,5x1	200 202 209 306 390 392	0,9
F AQ0014772	Flex G3/8" L400 Flessibile G3/8" L400 Tuyau G3/8" L400	200 202	1,3
C AQ0014769	Cartridge Ø25 Cartuccia Ø25 Cartouche Ø25	200 202 209	1,9
H AQ0014917 AQ0014918	Headwork G1/2" Vitone G1/2" Tête céramique G1/2"	306	4
H AQ0002135 AQ0003930	Headwork G1/2" Vitone G1/2" Tête céramique G1/2"	390 392	1,6



INDUSTRIA

ARTICLE ARTICOLO ARTICLE	DESCRIPTION DESCRIZIONE DESCRIPTION	BY MODEL PER MODELLO PAR MODÈLE	COEFFICIENT COEFFICIENTE COEFFICIENT
A AQ0014236	Aerator basin kit M16,5x1 Kit aeratore M16,5x1 Kit mousseur M16,5x1	200 206	0,6
F AQ0011013	Flex G3/8" L400 Flessibile G3/8" L400 Tuyau G3/8" L400	200	1,1
C AQ0013098	Cartridge Ø25 Cartuccia Ø25 Cartouche Ø25	200 202	1,5
A AQ0009836	Aerator basin kit Honeycomb Kit aeratore Honeycomb Kit mousseur Honeycomb	200 202	0,6
F AQ0000932	Flex G3/8" L400 Flessibile G3/8" L400 Tuyau G3/8" L400	202	1,1
C AQ0004095	Cartridge Ø35 Cartuccia Ø35 Cartouche Ø35	206	1,0
H AQ0002135 AQ0003930	Headwork G1/2" Vitone G1/2" Tête céramique G1/2"	392	1,6
A AQ0015903	Aerator basin kit M16,5x1 Kit aeratore M16,5x1 Kit mousseur M16,5x1	392	0,8

TAAAC

ARTICLE ARTICOLO ARTICLE	DESCRIPTION DESCRIZIONE DESCRIPTION	BY MODEL PER MODELLO PAR MODÈLE	COEFFICIENT COEFFICIENTE COEFFICIENT
C AQ0015245	Cartridge Ø35 Cartuccia Ø35 Cartouche Ø35	200 202	1,3
A AQ0013390	Aerator basin kit M24x1 Kit aeratore M24x1 Kit mousseur M24x1	200 202	0,7
F AQ0000932	Flex G3/8" L400 Flessibile G3/8" L400 Tuyau G3/8" L400	200 202	1,1
C AQ0004095	Cartridge Ø35 Cartuccia Ø35 Cartouche Ø35	206	1,0
A AQ0015239	Aerator basin kit M24x1 Kit aeratore M24x1 Kit mousseur M24x1	206	0,5
H AQ0002135 AQ0003930	Headwork G1/2" Vitone G1/2" Tête céramique G1/2"	392	1,6
F AQ0014772	Flex G1/2" L400 Flessibile G1/2" L400 Tuyau G1/2" L400	392	1,3

K2 / K3

ARTICLE ARTICOLO ARTICLE	DESCRIPTION DESCRIZIONE DESCRIPTION	BY MODEL PER MODELLO PAR MODÈLE	COEFFICIENT COEFFICIENTE COEFFICIENT
C AQ0013479	Cartridge Ø25 Cartuccia Ø25 Cartouche Ø25	200 202	1,6
A AQ0013478	Aerator basin kit M24x1 Kit aeratore M24x1 Kit mousseur M24x1	200 202 206	0,6
F AQ0011013	Flex G3/8" L450 Flessibile G3/8" L450 Tuyau G3/8" L450	200 202	1,1
C AQ0014791	Cartridge Ø35 Cartuccia Ø35 Cartouche Ø35	206	1,8

LOVEME

ARTICLE ARTICOLO ARTICLE	DESCRIPTION DESCRIZIONE DESCRIPTION	BY MODEL PER MODELLO PAR MODÈLE	COEFFICIENT COEFFICIENTE COEFFICIENT
C AQ0010039	Cartridge Ø35 Cartuccia Ø35 Cartouche Ø35	200 202	1,2
F AQ0013478	Flex G1/2" L400 Flessibile G1/2" L400 Tuyau G1/2" L400	200 202	1,7
C AQ0010069	Cartridge Ø35 Cartuccia Ø35 Cartouche Ø35	206	1,2
H AQ0010297 AQ0010298	Headwork G1/2" Vitone G1/2" Tête céramique G1/2"	390 392	1,8

BELMONDO

ARTICLE ARTICOLO ARTICLE	DESCRIPTION DESCRIZIONE DESCRIPTION	BY MODEL PER MODELLO PAR MODÈLE	COEFFICIENT COEFFICIENTE COEFFICIENT
C AQ0013098	Cartridge Ø25 Cartuccia Ø25 Cartouche Ø25	200	1,5
A AQ0012140	Aerator basin kit M24x1 Kit aeratore M24x1 Kit mousseur M24x1	200	0,6
F AQ0011013	Flex G3/8" L450 Flessibile G3/8" L450 Tuyau G3/8" L450	200	1,1
H AQ0010516 AQ0010515	Headwork G1/2" Vitone G1/2" Tête céramique G1/2"	205	1,6
F AQ0000932	Flex G3/8" L400 Flessibile G3/8" L400 Tuyau G3/8" L400	205	1,1
H AQ0010852 AQ0010851	Headwork G1/2" Vitone G1/2" Tête céramique G1/2"	306	1,9
H AQ0010528 AQ0010529	Headwork G1/2" Vitone G1/2" Tête céramique G1/2"	390 392	1,8
A AQ0014147	Aerator basin kit M16,5x1 Kit aeratore M16,5x1 Kit mousseur M16,5x1	390 392	1,8

WAVE

ARTICLE ARTICOLO ARTICLE	DESCRIPTION DESCRIZIONE DESCRIPTION	BY MODEL PER MODELLO PAR MODÈLE	COEFFICIENT COEFFICIENTE COEFFICIENT
C AQ0013479	Cartridge Ø25 Cartuccia Ø25 Cartouche Ø25	200 202	1,6
A AQ0012140	Aerator basin kit M24x1 Kit aeratore M24x1 Kit mousseur M24x1	200 202 206	0,6
F AQ0011013	Flex G3/8" L450 Flessibile G3/8" L450 Tuyau G3/8" L450	200	1,1
F AQ0012229	Flex G3/8" L450 Flessibile G3/8" L450 Tuyau G3/8" L450	202	1,1
C AQ0013189	Cartridge Ø35 Cartuccia Ø35 Cartouche Ø35	206	1,3



TWITTER

ARTICLE ARTICOLO ARTICLE	DESCRIPTION DESCRIZIONE DESCRIPTION	BY MODEL PER MODELLO PAR MODÈLE	COEFFICIENT COEFFICIENTE COEFFICIENT
C AQ0013098	Cartridge Ø25 Cartuccia Ø25 Cartouche Ø25	200 202	1,5
A AQ0013746	Aerator basin kit M18x1 Kit aeratore M18x1 Kit mousseur M18x1	200 202 206	0,6
F AQ0011013	Flex G3/8" L450 Flessibile G3/8" L450 Tuyau G3/8" L450	200 202	1,1
C AQ0004095	Cartridge Ø35 Cartuccia Ø35 Cartouche Ø35	206	1,0
A AQ0013746	Aerator basin kit M18,5x1 Kit aeratore M18,5x1 Kit mousseur M18,5x1	206	0,6

SUPERBOX

ARTICLE ARTICOLO ARTICLE	DESCRIPTION DESCRIZIONE DESCRIPTION	BY MODEL PER MODELLO PAR MODÈLE	COEFFICIENT COEFFICIENTE COEFFICIENT
C AQ0011012	Cartridge Ø25 Cartuccia Ø25 Cartouche Ø25	200 202	2,0
F AQ0000932	Flex G3/8" L400 Flessibile G3/8" L400 Tuyau G3/8" L400	200 202	1,1
H AQ0010172	Headwork G3/4" Vitone G3/4" Tête céramique G3/4"	306	1,8
H AQ0010848 AQ0010849	Headwork G1/2" Vitone G1/2" Tête céramique G1/2"	390 392	1,6

MILANOTORINO

ARTICLE ARTICOLO ARTICLE	DESCRIPTION DESCRIZIONE DESCRIPTION	BY MODEL PER MODELLO PAR MODÈLE	COEFFICIENT COEFFICIENTE COEFFICIENT
A AQ0014236	Aerator basin kit M16,5x1 Kit aeratore M16,5x1 Kit mousseur M16,5x1	200 206	0,6
F AQ0011013	Flex G3/8" L400 Flessibile G3/8" L400 Tuyau G3/8" L400	200	1,1
C AQ0013098	Cartridge Ø25 Cartuccia Ø25 Cartouche Ø25	200 202	1,5
A AQ0009836	Aerator basin kit Honeycomb Kit aeratore Honeycomb Kit mousseur Honeycomb	202	0,6
F AQ0000932	Flex G3/8" L400 Flessibile G3/8" L400 Tuyau G3/8" L400	202	1,1
C AQ0004095	Cartridge Ø35 Cartuccia Ø35 Cartouche Ø35	206	1,0
H AQ0002135 AQ0003930	Headwork G1/2" Vitone G1/2" Tête céramique G1/2"	392	1,6
A AQ0015903	Aerator basin kit M16,5x1 Kit aeratore M16,5x1 Kit mousseur M16,5x1	392	0,8
A AQ0014236	Aerator basin kit M16,5x1 Kit aeratore M16,5x1 Kit mousseur M16,5x1	206	0,6

BATLO'

ARTICLE ARTICOLO ARTICLE	DESCRIPTION DESCRIZIONE DESCRIPTION	BY MODEL PER MODELLO PAR MODÈLE	COEFFICIENT COEFFICIENTE COEFFICIENT
A AQ0009836	Aerator basin kit Honeycomb Kit aeratore Honeycomb Kit mousseur Honeycomb	200 202 392	0,6
F AQ0011013	Flex G3/8" L400 Flessibile G3/8" L400 Tuyau G3/8" L400	200 202	1,1
C AQ0010963	Cartridge Ø25 Cartuccia Ø25 Cartouche Ø25	200 202	2,0
F AQ0000932	Flex G3/8" L400 Flessibile G3/8" L400 Tuyau G3/8" L400	202	1,1
C AQ0010964	Cartridge Ø35 Cartuccia Ø35 Cartouche Ø35	206	1,2
H AQ0010528 AQ0010529	Headwork G1/2" Vitone G1/2" Tête céramique G1/2"	392	1,8
A AQ0014236	Aerator basin kit M16,5x1 Kit aeratore M16,5x1 Kit mousseur M16,5x1	206	0,6

ONLYONE

ARTICLE ARTICOLO ARTICLE	DESCRIPTION DESCRIZIONE DESCRIPTION	BY MODEL PER MODELLO PAR MODÈLE	COEFFICIENT COEFFICIENTE COEFFICIENT
F AQ0000932	Flex G3/8" L400 Flessibile G3/8" L400 Flex G3/8" L400	200 202	1,1
C AQ0010513	Cartridge Ø25 Cartuccia Ø25 Cartouche Ø25	200 202 206	3,6
H AQ0002135 AQ0003930	Headwork G1/2" Vitone G1/2" Tête céramique G1/2"	392	1,6

RUBACUORI

ARTICLE ARTICOLO ARTICLE	DESCRIPTION DESCRIZIONE DESCRIPTION	BY MODEL PER MODELLO PAR MODÈLE	COEFFICIENT COEFFICIENTE COEFFICIENT
A AQ0014236	Aerator basin kit M24x1 Kit aeratore M24x1 Kit mousseur M24x1	200	0,6
F AQ0011013	Flex G3/8" L400 Flessibile G3/8" L400 Flex G3/8" L400	200 202	1,1
C AQ0013098	Cartridge Ø25 Cartuccia Ø25 Cartouche Ø25	200 202	1,5
A AQ0013390	Aerator basin kit M24x1 Kit aeratore M24x1 Kit mousseur M24x1	202	0,7
C AQ0004095	Cartridge Ø35 Cartuccia Ø35 Cartouche Ø35	206	1,0
A AQ0000020	Aerator basin kit M24x1 Kit aeratore M24x1 Kit mousseur M24x1	206	0,5



HEYJOE

ARTICLE ARTICOLO ARTICLE	DESCRIPTION DESCRIZIONE DESCRIPTION	BY MODEL PER MODELLO PAR MODÈLE	COEFFICIENT COEFFICIENTE COEFFICIENT
A AQ0000020	Aerator basin kit M24x1 Kit aeratore M24x1 Kit mousseur M24x1	200 202 206 392	0,5
F AQ0000932	Flex G3/8" L400 Flessibile G3/8" L400 Tuyau G3/8" L400	200 202	1,1
C AQ0010039	Cartridge Ø35 Cartuccia Ø35 Cartouche Ø35	200 202	1,2
C AQ0004095	Cartridge Ø35 Cartuccia Ø35 Cartouche Ø35	206	1,0
H AQ0002135 AQ0003930	Headwork G1/2" Vitone G1/2" Tête céramique G1/2"	392	1,6

BIRKIN

ARTICLE ARTICOLO ARTICLE	DESCRIPTION DESCRIZIONE DESCRIPTION	BY MODEL PER MODELLO PAR MODÈLE	COEFFICIENT COEFFICIENTE COEFFICIENT
H AQ0002135 AQ0003930	Headwork G1/2" Vitone G1/2" Tête céramique G1/2"	200 390	1,6
A AQ0000020	Aerator basin kit M24x1 Kit aeratore M24x1 Kit mousseur M24x1	200 390	0,5
F AQ0000932	Flex G3/8" L400 Flessibile G3/8" L400 Tuyau G3/8" L400	200 220	1,1
H AQ0010852 AQ0010851	Headwork G1/2" Vitone G1/2" Tête céramique G1/2"	306	1,9
A AQ0014147	Aerator basin kit M16,5x1 Kit aeratore M16,5x1 Kit mousseur M16,5x1	306	0,8

HERMES

ARTICLE ARTICOLO ARTICLE	DESCRIPTION DESCRIZIONE DESCRIPTION	BY MODEL PER MODELLO PAR MODÈLE	COEFFICIENT COEFFICIENTE COEFFICIENT
H AQ0002135 AQ0003930	Headwork G1/2" Vitone G1/2" Tête céramique G1/2"	205 390 392	1,6
A AQ0000020	Aerator basin kit M24x1 Kit aeratore M24x1 Kit mousseur M24x1	205 390 392	0,5
F AQ0000932	Flex G3/8" L400 Flessibile G3/8" L400 Tuyau G3/8" L400	205	1,1
H AQ0009356 AQ0009357	Headwork G1/2" Vitone G1/2" Tête céramique G1/2"	306	1,9
A AQ0014236	Aerator basin kit M16,5x1 Kit aeratore M16,5x1 Kit mousseur M16,5x1	306	0,6

KUSASI / KUSASI SHORT

ARTICLE ARTICOLO ARTICLE	DESCRIPTION DESCRIZIONE DESCRIPTION	BY MODEL PER MODELLO PAR MODÈLE	COEFFICIENT COEFFICIENTE COEFFICIENT
C AQ0004075	Cartridge Ø35 Cartuccia Ø35 Cartouche Ø35	200 202	1,0
A AQ0000020	Aerator basin kit M24x1 Kit aeratore M24x1 Kit mousseur M24x1	200 202 390 392	0,5
F AQ0000932	Flex G3/8" L400 Flessibile G3/8" L400 Tuyau G3/8" L400	205	1,1
F AQ0006235	Flex G3/8" L600 Flessibile G3/8" L600 Tuyau G3/8" L600	202	1,2
C AQ0004095	Cartridge Ø35 Cartuccia Ø35 Cartouche Ø35	206	1,0
A AQ0014236	Aerator basin kit M16,5x1 Kit aeratore M16,5x1 Kit mousseur M16,5x1	206	0,6
H AQ0002135 AQ0003930	Headwork G1/2" Vitone G1/2" Tête céramique G1/2"	390 392	1,6

AQUA

ARTICLE ARTICOLO ARTICLE	DESCRIPTION DESCRIZIONE DESCRIPTION	BY MODEL PER MODELLO PAR MODÈLE	COEFFICIENT COEFFICIENTE COEFFICIENT
C AQ0011042	Thermostatic cartridge Cartuccia termostatica Cartouche Thermostatique	All Tutti Tous	3,1
V CP12312	Not return valve Valvola di non ritorno Clapet anti-retour	All Tutti Tous	1,1
V CP12311	Not return valve Valvola di non ritorno Clapet anti-retour	All Tutti Tous	1,1
H AQ0014336	Headwork G1/2" Vitone G1/2" Tête céramique G1/2"	All Tutti Tous	1,1

BUILT-IN EXTENSIONS

ARTICLE ARTICOLO ARTICLE	DESCRIPTION DESCRIZIONE DESCRIPTION	BY MODEL PER MODELLO PAR MODÈLE	COEFFICIENT COEFFICIENTE COEFFICIENT
KSP001CCPR_1	Built-in extensions kit Kit prolunga incasso Kit d'extension pour encastré	206 (Y)	3,3
KRC048CCXN_1	Built-in extensions kit Kit prolunga incasso Kit d'extension pour encastré	300(Y)	3,1
KSP002CCPR_1	Built-in extensions kit Kit prolunga incasso Kit d'extension pour encastré	310 (Y)	4,2
KSP003CCPR_1	Built-in extensions kit Kit prolunga incasso Kit d'extension pour encastré	312 (Y)	4,2
KSP004CCPR_1	Built-in extensions kit Kit prolunga incasso Kit d'extension pour encastré	313 (Y)	4,5
KSP005CCPR_1	Built-in extensions kit Kit prolunga incasso Kit d'extension pour encastré	314 (Y)	4,5



KSP006CCPR_1	Built-in extensions kit Kit prolunga incasso Kit d'extension pour encastré	206 BATLÓ	3,2
KRC789CCXN_1	Built-in extensions kit Kit prolunga incasso Kit d'extension pour encastré	300 BATLÓ	2,9
KSP007CCPR_1	Built-in extensions kit Kit prolunga incasso CvKit d'extension pour encastré	310 BATLÓ	4,1
KSP008CCPR_1	Built-in extensions kit Kit prolunga incasso Kit d'extension pour encastré	312 BATLÓ	4,0
KSP009CCPR_1	Built-in extensions kit Kit prolunga incasso Kit d'extension pour encastré	313 BATLÓ	4,3
KSP010CCPR_1	Built-in extensions kit Kit prolunga incasso Kit d'extension pour encastré	314 BATLÓ	4,3
KSP011CCPR_1	Built-in extensions kit Kit prolunga incasso Kit d'extension pour encastré	206 WAVE / BOLD	3,2
KRC783CCXN_1	Built-in extensions kit Kit prolunga incasso Kit d'extension pour encastré	300 WAVE / BATLÓ	2,9
KSP012CCPR_1	Built-in extensions kit Kit prolunga incasso Kit d'extension pour encastré	310 WAVE / BOLD	4,2
KSP013CCPR_1	Built-in extensions kit Kit prolunga incasso Kit d'extension pour encastré	312 WAVE / BOLD	4,1
KSP014CCPR_1	Built-in extensions kit Kit prolunga incasso Kit d'extension pour encastré	313 WAVE / BOLD	4,3
KSP015CCPR_1	Built-in extensions kit Kit prolunga incasso Kit d'extension pour encastré	314 WAVE / BOLD	4,3
KSP016CCPR_1	Built-in extensions kit Kit prolunga incasso Kit d'extension pour encastré	206 LOVEME	3,3
KRC1089CCXN_1	Built-in extensions kit Kit prolunga incasso Kit d'extension pour encastré	300 LOVEME	2,9
KSP017CCPR_1	Built-in extensions kit Kit prolunga incasso Kit d'extension pour encastré	310 LOVEME	4,2
KSP018CCPR_1	Built-in extensions kit Kit prolunga incasso Kit d'extension pour encastré	312 LOVEME	4,2
KSP019CCPR_1	Built-in extensions kit Kit prolunga incasso Kit d'extension pour encastré	313 LOVEME	4,5
KSP020CCPR_1	Built-in extensions kit Kit prolunga incasso Kit d'extension pour encastré	314 LOVEME	4,5
KRC697CCXN_1	Built-in extensions kit Kit prolunga incasso Kit d'extension pour encastré	300 BELMONDO	3,1
KRC697CCXN_1	Built-in extensions kit Kit prolunga incasso Kit d'extension pour encastré	300 BELMONDO	3,1
KSP021CCPR_1	Built-in extensions kit Kit prolunga incasso Kit d'extension pour encastré	310 BELMONDO	4,2
KSP022CCPR_1	Built-in extensions kit Kit prolunga incasso Kit d'extension pour encastré	312 BELMONDO	4,2
KSP023CCPR_1	Built-in extensions kit Kit prolunga incasso Kit d'extension pour encastré	313 BELMONDO	4,5
KSP024CCPR_1	Built-in extensions kit Kit prolunga incasso Kit d'extension pour encastré	314 BELMONDO	4,4



SF

**SURFACE
FINITURE
FINITIONS**

We are all finishes company.

Siamo l'azienda per tutte le finiture.
Nous sommes l'entreprise de toute finition.

Every human being is a range of perceptions, unrepeatably in its originality. IB Rubinetti allows you to decorate your bathroom choosing from a selection of sixteen finishes, directly attended by our chrome plating department, in order to mirror your incomparable personality in every detail.

Ogni essere umano è un ventaglio inedito di sensazioni, irripetibile nella sua originalità. IB Rubinetti permette di ornare il tuo bagno scegliendo tra una gamma di sedici finiture, direttamente curate dal nostro reparto di cromatura, per riflettere in ogni dettaglio la tua ineguagliabile personalità.

Chaque être humain est un éventail de perceptions, unique dans son originalité. IB Rubinetti vous permet de décorer votre salle de bain en choisissant parmi une gamme de seize finitions, directement gérée par notre département de chromage, afin de retrouver dans les moindres détails votre incomparable personnalité.

All finishes are made by IB with the best technology and know-how to guarantee your peace of mind.

Tutte le finiture sono realizzate da IB con la migliore tecnologia per garantire la massima qualità.

Toutes ces finitions sont fabriquées par IB avec la meilleure technologie et savoir-faire pour garantir votre tranquillité d'esprit.



LEAD FREE



ZINC FREE

From the faucet to the flush plate, one finishing, your favourite.

Dal rubinetto alla placca del WC in un'unica finitura, la tua preferita.

Du robinet à la plaque de commande WC, tout en une seule finition, votre favorite.

FAUCET FOR WASHBASIN / BIDET | RUBINETTO PER LAVABO / BIDET | ROBINET POUR LAVABO / BIDET

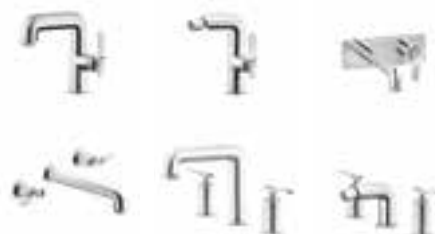

SHOWER CONTROL | CONTROLLO DOCCIA | COMMANDE DE DOUCHE



SHOWER HEAD | SOFFIONI DOCCIA | TÊTE DE DOUCHE



ACCESSORIES | ACCESSORI | ACCESSOIRES



BATH FILLER | BORDO VASCA | BAIN



















SHUT-OFF AND FLUSH PLATE | INDROSCOPINO E PLACCA SCARICO | DOUCHETTE BIDET ET PLAQUE DE DÉCLENCHEMENT WC



CC		CHROME CHROMO CHROME
PL		PLATINUM PLATINO PLATINE
SS		BRUSHED NICKEL NICKEL SPAZZOLATO NICKEL BROSSÉ
ON		NATURAL BRASS OTTONE NATURALE LAITON NATUREL
BO		MATT WHITE BIANCO OPACO BLANC MAT
NP		MATT BLACK NERO OPACO NOIR MAT
CF		BLACK CHROME BLACK CHROME BLACK CHROME
CS		BRUSHED BLACK CHROME BLACK CHROME SPAZZOLATO BLACK CHROME BROSSÉ
II		PALE GOLD 18K ORO INGLESE 18K OR PALE 18K
IS		BRUSHED PALE GOLD 18K ORO INGLESE SPAZZOLATO 18K OR PALE BROSSÉ 18K
RS		ROSE GOLD 18K ORO ROSA 18K OR ROSE 18K
SR		BRUSHED ROSE GOLD 18K ORO ROSA SPAZZOLATO 18K OR ROSE BROSSÉ 18K
OO		GOLD 22K ORO 22K OR 22K
OS		BRUSHED GOLD 22K ORO SPAZZOLATO 22K OR BROSSÉ 22K
RR		ANTIQUE COPPER RAME ANTICO CUIVRE ANTIQUE
BB		ANTIQUE BRONZE BRONZO ANTICO BRONZE ANTIQUE

ICONS INDEX

CC		CHROME CHROMO CHROME
PL		PLATINUM PLATINO PLATINE
SS		BRUSHED NICKEL NICKEL SPAZZOLATO NICKEL BROSSÉ
ON		NATURAL BRASS OTTONE NATURALE LAITON NATUREL
BO		MATT WHITE BIANCO OPACO BLANC MAT
NP		MATT BLACK NERO OPACO NOIR MAT
CF		BLACK CHROME BLACK CHROME BLACK CHROME
CS		BRUSHED BLACK CHROME BLACK CHROME SPAZZOLATO BLACK CHROME BROSSÉ
II		PALE GOLD 18K ORO INGLESE 18K OR PALE 18K
IS		BRUSHED PALE GOLD 18K ORO INGLESE SPAZZOLATO 18k OR PALE BROSSÉ 18k
RS		ROSE GOLD 18K ORO ROSA 18K OR ROSE 18K
SR		BRUSHED ROSE GOLD 18K ORO ROSA SPAZZOLATO 18K OR ROSE BROSSÉ 18K
OO		GOLD 22K ORO 22K OR 22K
OS		BRUSHED GOLD 22K ORO SPAZZOLATO 22K OR BROSSÉ 22K
RR		ANTIQUE COPPER RAME ANTICO CUIVRE ANTIQUE
BB		ANTIQUE BRONZE BRONZO ANTICO BRONZE ANTIQUE

FUNCTIONS | FUNZIONI | FONCTIONS



Thermostatic control
Comando termostatico
Régulation thermostatique



Electronic control
Controllo elettronico
Contrôle électronique



Free intensity adjustment
Regolazione intensità indipendente
Réglage indépendant de l'intensité



Rotating spout
Bocca rotante
Bec rotatif



Function control
Controllo delle funzioni
Contrôle des fonctions



RGB LED light
Luce RGB LED
Lumière LED RGB

MATERIALS | MATERIALI | MATÉRIEL



Lead free solid brass
Ottone senza piombo
Laiton sans plomb



Produced in abs
Prodotto in abs
Produit en abs



Zinc free solid brass
Ottone senza zinco
Zinc sans plomb



Outdoor resistant
Resistente all'esterno
Résistant à l'extérieur

WATER JET | GETTI D'ACQUA | JET D'EAU



Rain jet
Getto pioggia
Jet de pluie



Concentrated rain jet
Getto pioggia concentrato
Jet de pluie concentré



Nebulization
Nebulizzazione
Pulvérisation



Aerated jet
Getto areato
Jet aéré



Waterfall
Cascata
Cascade



Double waterfall
Cascata doppia
Double cascade



Hand shower
Doccino
Douchette



Bodyjet
Bodyjet
Bodyjet



CODE AND TABLE INSTRUCTION

TALKING CODE | CODICE PARLANTE | CODE DE PAROLE

ID **200** **CC** **_1**

COLLECTION | COLLEZIONE | COLLECTION
 ARTICLE | ARTICOLO | ARTICLE
 FINISHES | FINITURA | FINITIONS
 DETAILS FINISHES | FINITURA DETTAGLI | FINITIONS DÉTAILS

TALKING CODE | CODICE PARLANTE | CODE DE PAROLE

A	B	L	D	C	E	F	G	H	I	
ARTICLE ARTICOLO ARTICLE	B2206		Wall mounted washbasin mixer complete with drain Miscelatore lavabo due fori a parete completo di scarico automatico Mitigeur lavabo mural complet avec bonde automatique			CODE / COEFFICIENT CODICE / COEFFICIENTE E2206CC 14,6 SR B2206SS 15,9 GN B2206GN 12,6 NP B2206NP 15,1 CF B2206CF 18,9 CS B2206CS 20,2 II B2206II 18,9 IS B2206IS 20,2 RS B2206RS 18,9 SR B2206SR 20,2 OD B2206OD 18,9 OS B2206OS 20,2 LEV. ROSSA (RED LEVER) / POUCE LEVER + 0,1		PACKAGING L: 265 mm D: 260 mm H: 70 mm 1,755 kg	PORTATE WATER FLOW DÉBIT D'EAU 1 BAR 3,3 l/m 2 BAR 4,4 l/m 3 BAR 4,5 l/m	
Built-in body to be purchased separately Corpo incasso da acquistare separatamente Corps intégré à acheter séparément			CODICE CODE CODE INC206CCXN_19 COEFFICIENT COEFFICIENTE COEFFICIENT 2,9							

- | | |
|--|---|
| A Article
Articolo
Article | F Coefficient
Coefficiente
Coefficient |
| B Product image
Immagine prodotto
Image du produit | G Packaging dimension and weight
Dimensione e peso dell'imballaggio
Dimensions et poids de l'emballage |
| C Description
Descrizione
Description | H Water flow
Portate
Débit d'eau |
| D Finishes reference
Riferimento finitura
Référence de finition | I Product dimensions
Diemsnioni prodotto
Dimension du produit |
| E Final product code
Codice prodotto finito
Code du produit final | L Any built-in parts
Eventuali parti incasso
Toutes les pièces encastrées |

GENERAL TERMS AND CONDITIONS OF SALE

General

IB Rubinetterie Spa shall assume this manufacturer's guarantee towards consumers of IB Rubinetterie Spa products in addition to the legal guarantee to which the consumer is entitled in relation to the seller. It shall apply without prejudice to mandatory liability regulations, such as those in accordance with the Product Liability Act, in cases of wilful intent and gross negligence, or resulting from loss of life, physical injury or damage to health by IB Rubinetterie Spa or its agents.

The term "consumer" in this manufacturer's guarantee shall refer to any natural person who owns the product and has not purchased it for the purpose of resale to or installation for a third party within the scope of its commercial or self-employed professional activities. The term "primary customer" shall mean the consumer who has directly purchased the product from IB Rubinetterie Spa or a dealer or other natural or legal person who resells or installs the product within the scope of its commercial or self-employed professional activities.

Guarantee protection

Valid for IB Rubinetterie Spa products purchased by primary customers on or after 01/01/2010 (purchase receipt):

IB Rubinetterie Spa guarantees consumers that its products are free from material, manufacturing and design faults. The latest science and technology at the time of manufacture is decisive in this regard. The defect giving rise to the damage must already have been present in the product at this time. Claims for the reimbursement of consequential damage or on the grounds of product liability shall only be valid in accordance with mandatory legal regulations.

This guarantee shall be valid for five years from the purchase date by the primary customer, and for a maximum of six years from the date of manufacture. The guarantee period shall not be extended due to the provision of services within the scope of this guarantee, especially not in the event of servicing or replacement. In such cases, the guarantee period shall also not start anew.

Written notification of defects

The consumer shall be entitled to assert the rights from this guarantee by providing IB Rubinetterie Spa or the dealer from whom the primary customer purchased the product with a written notification of defect within the guarantee period. The consumer must also provide notification of the defect within two months of its detection or the time at which its detection must have been possible. The consumer shall be obliged to prove that the guarantee has not expired (for example, by presenting the primary customer's purchase receipt). IB Rubinetterie Spa shall also be entitled to determine the start of the guarantee period on the basis of the data of manufacture.

Services in the event of a guarantee claim

IB Rubinetterie Spa shall be entitled to repair or replace the product, or to reimburse the consumer the purchase price.

Usually, the consumer has the faulty product repaired by a specialist on site with the prior agreement of IB Rubinetterie Spa. In such an event, the guarantee shall cover the free delivery of the necessary spare parts. If IB Rubinetterie Spa issues a written decision to conduct the maintenance itself, IB Rubinetterie Spa shall bear any costs that arise for spare parts, installation and labour, as well as any expenses incurred through the transportation or dispatch of the product. The consumer must provide access to the product.

In the event of a replacement, the old product shall be replaced by a new product of the same kind, value and type. If the product in question is no longer manufactured at the time at which the defect is reported, IB Rubinetterie Spa shall be entitled to

supply a similar product. Transport or dispatch to and from IB Rubinetterie Spa or to and from the dealer, any de-installation and re-installation of the product or any other special measures can only be carried out with the prior agreement of IB Rubinetterie Spa. If IB Rubinetterie Spa agrees to the intended measure, IB Rubinetterie Spa shall bear the costs arising from the measure being conducted. Unless otherwise agreed, the consumer shall undertake to collect the new product from the nearest IB Rubinetterie Spa dealer.

If IB Rubinetterie Spa chooses to reimburse the purchase price and confirms this in writing, the consumer shall return the product and IB Rubinetterie Spa shall reimburse the purchase price paid.

Conditions and exclusions

This guarantee shall only be valid if installation and maintenance have been duly conducted in accordance with the operating instructions and generally accepted engineering practices (e.g. by a master craftsman or authorised specialist), the operating instructions have been complied with and the IB Rubinetterie Spa products have been used in line with the technical and maintenance instructions provided by IB Rubinetterie Spa.

This shall include but not be limited to the inlet water pipes being duly flushed, especially prior to the product's installation or following construction measures in accordance with the valid standards, installation work complying with the appended diagrams and checks being conducted on the compliance of the working pressure in the water mains with technical specifications.

Installation, usage and maintenance instructions are provided with all products and can be found on www.ibrubinetterie.it

The guarantee shall not cover:

- Wear to wear and tear parts such as seals;
- Breakage of breakable components such as glass or bulbs;
- The exhaustion of consumable materials such as batteries, filters or aerators;
- Slight deviations of the IB Rubinetterie Spa products from the target quality that do not affect the usability of the product;
- Cleaning, water jets, in particular hot water jets, lime-scale deposits, operating and handling errors, damage caused by aggressive environmental influences, chemicals or detergents;
- Product defects caused by the installation, transportation or test operation of the purchased item;
- Damage caused by the faulty IB Rubinetterie Spa product;
- Display products and similar.
- The guarantee shall not be valid in the event of:
 - Non-compliance with the installation, maintenance and usage instructions appended or provided at www.ibrubinetterie.it;
 - Installation, maintenance, repair or servicing by non-qualified persons;
 - Product damage caused by the seller, plumber or third persons;
 - Damage that can be attributed to normal wear or intentional damage – in the event of negligent damage, contributory negligence shall be offset on agreement;
 - Improper installation or commissioning;
 - Insufficient or improper maintenance;
 - Products that have not been or are not used in line with their



intended purpose;

- Damage caused by force majeure or natural disasters, especially but not limited to floods, fires or frost damage.

Non-applicability of the guarantee

If a product defect is not covered by this guarantee, any costs that arise from the dispatch and transportation of the product shall be borne by the consumer. The consumer must also bear any costs, including labour costs, arising from the inspection of the product, as well as the costs of de-installing and re-installing the product.

If, having been informed of the non-applicability of the guarantee and the potential costs that could arise through the servicing activities, the consumer wishes the servicing activities to be conducted, it must also bear the costs of the spare parts and labour.

If the product defect was not present upon delivery, IB Rubinetterie Spa shall decide on a case-by-case basis whether said defect can be rectified through goodwill. In such cases, the consumer shall not have any legal right to the rectification of the defect.

Legal rights

In addition to the rights from the guarantee, the consumer shall also be entitled to statutory rights. These sometimes lesser rights for the consumer shall not be restricted by the guarantee. The guarantee shall also not affect the rights of the primary customer and, where applicable, the consumer in relation to the seller from whom the primary customer procured the product.

Place of fulfilment, place of jurisdiction and applicable laws

This guarantee shall be subject to Italian law under the exclusion of the UN Convention on Contracts for the International Sale of Goods (CISG) of 11 April 1980. The place of fulfilment for the obligations under this guarantee shall be Brescia, Italy. Where permissible, the place of jurisdiction shall be Brescia, Italy.



IB RUBINETTI CLEANING RECOMMENDATION

Today, modern sanitary and kitchen tapware, showers, accessories, washbasins, tubs and radiators consist of very different materials to comply with the needs of the market with regard to design and functionality. To avoid damage and claims, it is necessary to consider certain criteria when cleaning.

With regard to cleaning IB RUBINETTI products, the following points must be observed:

- Only use cleaning material which is explicitly provided for this type of application.
- Never use cleaning materials, which contain hydrochloric acid, formic acid, chlorine bleaching lye or acetic acid, as they cause considerable damage.
- Phosphorus acidic cleaners are only applicable under certain conditions.
- Mixing different cleaning agents is generally not permitted.
- Never use cleaning materials or appliances with an abrasive effect, such as unsuitable cleaning powders, sponge pads or micro fibre cloths.
- The instructions of the cleaning agent manufacturers have to be followed closely.
- Cleaning has to be carried out with a specified dosage of cleaning detergent, for a suitable limited time, object-related and adapted to the needs.
- Limescale has to be removed by regularly cleaning.
- When using spray cleaners, spray the cleaning solution onto a soft cloth or sponge, never directly onto the IB RUBINETTI products, as the atomised spray could enter openings and gaps in the product and cause damage.
- After cleaning, rinse thoroughly with clean water to remove any cleaner residue.
- The use of steam cleaners is not permitted. The high temperatures can damage the products.

Important

Residues of toiletries such as liquid soaps, shampoos and shower gels, hair dyes, perfumes, aftershave and nail varnish can also cause damage. Here too: Carefully rinse with water after use to remove residues. Likewise, do not store any cleaning agents or chemicals under the products, for example in a vanity unit, as the vapours may damage the products.

Components with damaged surfaces must be exchanged otherwise there could be a risk of injury. Damage caused by improper treatment is not covered by our guarantee.

CONDIZIONI GENERALI DI VENDITA

Generale

IB Rubinetterie Spa assumerà la garanzia del produttore nei confronti dei consumatori dei prodotti IB Rubinetterie Spa oltre alla garanzia legale a cui il consumatore ha diritto in relazione al venditore. Si applica senza pregiudizio delle norme di responsabilità obbligatoria, come quelle in conformità con la legge sulla responsabilità del prodotto, in caso di dolo intenzionale e colpa grave, o derivanti dalla perdita di vite umane, lesioni fisiche o danni alla salute da parte di IB Rubinetterie Spa o dei suoi agenti.

Il termine "consumatore" nella presente garanzia del produttore si riferisce a qualsiasi persona fisica proprietaria del prodotto e che non l'abbia acquistata a scopo di rivendita o installazione per conto di terzi nell'ambito delle sue attività professionali commerciali o indipendenti. Con il termine "cliente principale" si intende il consumatore che ha acquistato direttamente il prodotto da IB Rubinetterie Spa o un rivenditore o altra persona fisica o giuridica che rivende o installa il prodotto nell'ambito delle sue attività professionali commerciali o indipendenti.

Garanzia di protezione

Valido per i prodotti IB Rubinetterie Spa acquistati dai clienti primari a partire dall'01 / 01/2010 (ricevuta di acquisto):

IB Rubinetterie Spa garantisce ai consumatori che i suoi prodotti sono privi di materiali, produzione e difetti di progettazione. L'ultima scienza e tecnologia al momento della produzione è decisiva a questo proposito. Il difetto all'origine del danno deve già essere stato presente nel prodotto in questo momento. Reclami per il rimborso di danni conseguenti o sulla base della responsabilità del prodotto è valida solo in conformità con le norme di legge obbligatorie.

Questa garanzia sarà valida per cinque anni dalla data di acquisto da parte del cliente principale e per un massimo di sei anni dalla data di produzione. Il periodo di garanzia non può essere esteso a causa della fornitura di

servizi nell'ambito di questa garanzia, in particolare non in caso di assistenza o sostituzione.

In tali casi, anche il periodo di garanzia non deve iniziare di nuovo.

Condizioni ed esclusioni

Questa garanzia è valida solo se l'installazione e la manutenzione sono state eseguite correttamente in conformità con le istruzioni operative e le pratiche ingegneristiche generalmente accettate (ad esempio da un maestro artigiano o specialista autorizzato), le istruzioni operative sono state rispettate e i prodotti IB Rubinetterie Spa hanno è stato utilizzato in linea con le istruzioni tecniche e di manutenzione fornite da IB Rubinetterie Spa.

Ciò deve includere ma non essere limitato al fatto che i tubi dell'acqua di ingresso siano debitamente lavati, specialmente prima dell'installazione del prodotto o in seguito a misure di costruzione conformi alle norme vigenti, lavori di installazione conformi agli schemi allegati e verifiche condotte sulla conformità del funzionamento pressione nella rete idrica con specifiche tecniche.

Le istruzioni di installazione, uso e manutenzione sono fornite con tutti i prodotti e possono essere trovate su www.ibrubinetterie.it

La garanzia non copre:

- Indossare parti soggette ad usura come guarnizioni;
- Rottura di componenti fragili come vetro o lampadine;
- L'esaurimento di materiali di consumo come batterie, filtri o aeratori;

- Lievi deviazioni dei prodotti IB Rubinetterie Spa dalla qualità target che non pregiudicano l'usabilità del prodotto;
- Pulizia, getti d'acqua, in particolare getti d'acqua calda, depositi di calcare, errori di funzionamento e di manipolazione, danni causati da influenze ambientali aggressive, prodotti chimici o detergenti;
- Difetti del prodotto causati dall'installazione, trasporto o collaudo dell'elemento acquistato;
- Danni causati dal prodotto difettoso IB Rubinetterie Spa;
- Visualizza prodotti e simili.

La garanzia non è valida in caso di:

- Inosservanza delle istruzioni di installazione, manutenzione e utilizzo allegate o fornite su www.ibrubinetterie.it;
- Installazione, manutenzione, riparazione o assistenza da parte di persone non qualificate;
- Danni al prodotto causati dal venditore, dall'idraulico o da terze persone;
- Danni che possono essere attribuiti a normale usura o danno intenzionale - in caso di danno colposo, la negligenza contributiva deve essere compensata su accordo;
- Installazione o messa in servizio errate;
- Manutenzione insufficiente o impropria;
- Prodotti che non sono stati o non sono utilizzati in conformità con lo scopo previsto;
- Danni causati da cause di forza maggiore o disastri naturali, in particolare ma non limitati a inondazioni, incendi o danni da gelo.

Non applicabilità della garanzia

Se un difetto del prodotto non è coperto da questa garanzia, tutti i costi derivanti dalla spedizione e dal trasporto del prodotto sono a carico del consumatore. Il consumatore deve inoltre sostenere tutti i costi, compresi i costi di manodopera, derivanti dall'ispezione del prodotto, nonché i costi di disinstallazione e reinstallazione del prodotto.

Se, essendo stato informato della non applicabilità della garanzia e dei potenziali costi che potrebbero derivare dalle attività di servizio, il consumatore desidera che le attività di manutenzione siano condotte, deve anche sostenere i costi dei pezzi di ricambio e della manodopera.

Qualora il difetto del prodotto non fosse presente alla consegna, IB Rubinetterie Spa deciderà caso per caso se tale difetto possa essere rettificato tramite avviamento. In tali casi, il consumatore non ha alcun diritto legale alla rettifica del difetto.

Diritti legali

Oltre ai diritti derivanti dalla garanzia, il consumatore ha anche diritto ai diritti legali. Questi diritti a volte minori per il consumatore non devono essere limitati dalla garanzia. La garanzia non pregiudica inoltre i diritti del cliente principale e, se del caso, del consumatore in relazione al venditore presso il quale il cliente principale ha acquistato il prodotto.

Luogo di adempimento, luogo di giurisdizione e leggi applicabili

Tale garanzia sarà soggetta alla legge italiana con l'esclusione della Convenzione delle Nazioni Unite sui contratti di vendita internazionale di merci (CISG) dell'11 aprile 1980. Il luogo di adempimento per gli obblighi derivanti dalla presente garanzia sarà Brescia, Italia. Ove consentito, il foro competente è Brescia, Italia.





RACCOMANDAZIONE DI PULIZIA IB RUBINETTI

Oggi i moderni prodotti come rubinetteria sanitaria, rubinetteria da cucina, docce, accessori, lavabi, vasche e radiatori sono costituiti da materiali molto diversi per soddisfare le esigenze del mercato in termini di design e funzionalità. Per evitare danni e reclami, è necessario considerare alcuni criteri durante la pulizia.

Per quanto riguarda la pulizia dei prodotti IB RUBINETTI, è necessario osservare i seguenti punti:

- Utilizzare esclusivamente materiali di pulizia specificatamente previsti per questo tipo di applicazione.
- Non utilizzare mai detersivi che contengono acido cloridrico, acido formico, liscivia a base di cloro o acido acetico, poiché causano danni considerevoli.
- I detersivi acidi al fosforo sono applicabili solo in determinate condizioni.
- La miscelazione di detersivi diversi non è generalmente consentita.
- Non utilizzare mai materiali o apparecchi per la pulizia con un effetto abrasivo, come polveri detersivi non idonei, spugne o panni in microfibra.
- Le istruzioni dei produttori di detersivi devono essere seguite attentamente.
- La pulizia deve essere eseguita con un dosaggio specifico di detersivo per la pulizia, per un tempo limitato adatto, correlato all'oggetto e adattato alle esigenze.
- Il calcare deve essere rimosso regolarmente.
- Quando si usano detersivi spray, spruzzare la soluzione detersiva su un panno morbido o una spugna, mai direttamente sui prodotti IB RUBINETTI, poiché lo spray nebulizzato potrebbe penetrare nelle giunture e negli spazi vuoti del prodotto e causare danni.
- Dopo la pulizia, sciacquare abbondantemente con acqua pulita per rimuovere eventuali residui di detersivo.
- L'uso di pulitori a vapore non è permesso. Le alte temperature possono danneggiare i prodotti.

⚠ Importante

Residui di articoli da toilette come saponi liquidi, shampoo e gel doccia, tinture per capelli, profumi, dopobarba e smalto possono anch'essi causare danni. Anche qui: risciacquare accuratamente con acqua dopo l'uso per rimuovere i residui. Allo stesso modo, non conservare alcun detersivo o prodotto chimico sotto i prodotti, per esempio negli scompartimenti sotto al lavabo, in quanto i vapori potrebbero danneggiare i prodotti.

I componenti con superfici danneggiate devono essere sostituiti altrimenti potrebbe esserci il rischio di lesioni. I danni causati da un trattamento improprio non sono coperti dalla nostra garanzia.

FRA CONDITIONS DE VENTE

Général

IB Rubinetterie SpA assume la garantie du fabricant à l'égard des consommateurs des produits IB Rubinetterie SpA, en plus de la garantie légale à laquelle le consommateur a droit vis-à-vis du vendeur. Il s'applique sans préjudice des dispositions légales en matière de responsabilité, telles que celles prévues par la loi sur la responsabilité du fait des produits, en cas de faute intentionnelle ou de faute grave, résultant en une perte de la vie, d'une lésion corporelle ou d'un dommage à la santé de IB Rubinetterie SpA ou de ses agents.

Le terme «consommateur» dans la présente garantie du fabricant s'entend de toute personne physique propriétaire du produit qui ne l'a pas acheté à des fins de revente ou d'installation pour un tiers dans le cadre de ses activités professionnelles commerciales ou non salariées. Le terme «client primaire» désigne le consommateur qui a directement acheté le produit à IB Rubinetterie SpA ou à un revendeur ou une autre personne physique ou morale qui revend ou installe le produit dans le cadre de ses activités professionnelles commerciales ou non salariées.

Garantie de protection

Valable pour les produits IB Rubinetterie SpA achetés par les principaux clients à partir du 01/01/2010 (reçu d'achat):

IB Rubinetterie SpA garantit aux consommateurs que ses produits sont exempts de matières, de fabrication et défauts de conception. La science et la technologie les plus récentes au moment de la fabrication sont décisives à cet égard. Le défaut à l'origine du dommage doit déjà être présent dans le produit à ce moment. Demandes de remboursement de dommages indirects ou pour des motifs liés à la responsabilité du produit ne sera valable que conformément aux dispositions légales en vigueur.

Cette garantie est valable cinq ans à compter de la date d'achat par le client principal et au maximum six ans à compter de la date de fabrication. La période de garantie ne doit pas être prolongée en raison de la fourniture de services entrant dans le cadre de la présente garantie, notamment en cas d'entretien ou de remplacement. Dans ce cas, la période de garantie ne doit pas non plus recommencer.

Notification écrite des défauts

Le consommateur a le droit de tirer parti des droits de cette garantie en fournissant à IB Rubinetterie SpA ou au revendeur auprès duquel le client principal a acheté le produit un avis écrit du défaut dans le délai de garantie. Le consommateur doit également notifier le défaut dans les deux mois suivant sa détection ou le moment où sa détection doit avoir été possible. Le consommateur est tenu de prouver que la garantie n'a pas expiré (par exemple, en présentant le reçu d'achat du client principal).

IB Rubinetterie SpA est également habilitée à déterminer le début de la période de garantie sur la base des données de fabrication.

Services en cas de réclamation de garantie

IB Rubinetterie SpA est habilitée à réparer ou à remplacer le produit, ou à rembourser le prix d'achat au consommateur.

En règle générale, le consommateur fait réparer le produit défectueux par un spécialiste, avec l'accord préalable de IB Rubinetterie SpA. Dans ce cas, la garantie couvre la livraison gratuite des pièces de rechange nécessaires. Si IB Rubinetterie SpA publie une décision écrite concernant la maintenance elle-même, IB Rubinetterie SpA supportera tous les frais occasionnés par les pièces de rechange, l'installation et la main-d'œuvre, ainsi que les frais occasionnés par le transport ou l'envoi du produit. Le consommateur doit donner accès au produit.

En cas de remplacement, l'ancien produit doit être remplacé par un nouveau produit du même type, de la même valeur et du même type. Si le produit en question n'est plus fabriqué au moment

où le défaut est signalé, IB Rubinetterie SpA est autorisée à fournir un produit similaire. Le transport ou l'expédition vers et depuis IB Rubinetterie SpA ou vers et depuis le revendeur, toute désinstallation et réinstallation du produit ou toute autre mesure particulière ne peuvent être effectués qu'avec l'accord préalable de IB Rubinetterie SpA. Si IB Rubinetterie SpA accepte la mesure envisagée, IB Rubinetterie SpA assumera les coûts découlant de la mesure. Sauf convention contraire, le consommateur s'engage à retirer ce nouveau produit auprès du revendeur IB Rubinetterie SpA le plus proche.

Si IB Rubinetterie SpA choisit de rembourser le prix d'achat et le confirme par écrit, le consommateur retournera le produit et IB Rubinetterie SpA remboursera le prix d'achat payé.

Conditions et exclusions

Cette garantie n'est valable que si l'installation et la maintenance ont été dûment effectuées conformément aux instructions d'utilisation et aux pratiques techniques généralement acceptées (par exemple par un maître-artisan ou un spécialiste agréé), si les instructions d'utilisation ont été respectées et si les produits IB Rubinetterie SpA ont été utilisés conformément aux instructions techniques et de maintenance fournies par IB Rubinetterie SpA.

Cela inclut, sans toutefois s'y limiter, que les tuyaux d'arrivée d'eau soient dûment rincés, en particulier avant l'installation du produit ou après les mesures de construction conformément aux normes en vigueur, des travaux d'installation conformes aux schémas annexés et des contrôles en cours sur la conformité des conditions de travail pression dans les conduites d'eau avec spécifications techniques.

Les instructions d'installation, d'utilisation et de maintenance sont fournies avec tous les produits et peuvent être consultées sur www.ibrubinetterie.it

La garantie ne couvre pas:

- les pièces d'usure telles que les joints d'étanchéité;
- rupture de composants fragiles tels que le verre ou les ampoules;
- l'épuisement des matériaux consommables tels que les piles, les filtres ou les aérateurs;
- Légères déviations des produits IB Rubinetterie SpA par rapport à la qualité cible n'affectant pas la facilité d'utilisation du produit;
- nettoyage, jets d'eau, en particulier jets d'eau chaude, dépôts de calcaire, erreurs de fonctionnement et de manipulation, dommages causés par des influences environnementales agressives, produits chimiques ou détergents;
- les défauts du produit causés par l'installation, le transport ou le test de fonctionnement de l'article acheté;
- Dommages causés par le produit IB Rubinetterie SpA défectueux;
- Afficher les produits et similaires.

La garantie ne sera pas valable en cas de:

- Non-respect des instructions d'installation, de maintenance et d'utilisation annexées ou fournies sur le site www.ibrubinetterie.it;
- installation, maintenance, réparation ou entretien par des personnes non qualifiées;
- les dommages au produit causés par le vendeur, le plombier ou des tiers;
- Dommages pouvant être attribués à l'usure normale ou intentionnelle - en cas de dommage par négligence, la négligence contributive est compensée par accord;



- mauvaise installation ou mise en service;
- entretien insuffisant ou inapproprié;
- les produits qui n'ont pas été utilisés ou ne sont pas utilisés conformément à leur destination;
- Dommages causés par des cas de force majeure ou des catastrophes naturelles, notamment des inondations, des incendies ou des dégâts dus au gel.

Non-applicabilité de la garantie

Si un défaut de produit n'est pas couvert par cette garantie, tous les frais occasionnés par l'expédition et le transport du produit sont à la charge du consommateur. Le consommateur doit également supporter tous les coûts, y compris les coûts de main-d'œuvre, résultant de l'inspection du produit, ainsi que les coûts de désinstallation et de réinstallation du produit.

Si, après avoir été informé de la non-applicabilité de la garantie et des coûts potentiels pouvant découler des activités de maintenance, le consommateur souhaite que les activités de maintenance soient menées, il doit également supporter les coûts des pièces de rechange et de la main-d'œuvre.

Si le défaut du produit n'était pas présent à la livraison, IB Rubinetteria SpA décidera au cas par cas si ledit défaut peut être corrigé par le biais de l'achalandage. Dans ce cas, le consommateur n'a légalement aucun droit à la rectification du défaut.

Droits légaux

En plus des droits découlant de la garantie, le consommateur a également droit à des droits légaux. Ces droits parfois moindres pour le consommateur ne sont pas limités par la garantie. La garantie ne porte pas non plus atteinte aux droits du client primaire et, le cas échéant, du consommateur vis-à-vis du vendeur auprès duquel le client primaire a acheté le produit.

Lieu d'exécution, lieu d'exécution et lois applicables

La présente garantie est soumise à la loi italienne, à l'exclusion de la Convention des Nations Unies sur les contrats de vente internationale de marchandises (CVIM) du 11 avril 1980. Le lieu d'exécution des obligations découlant de cette garantie est Brescia, Italie. Le cas échéant, le lieu de juridiction sera Brescia, Italie.



RECOMMANDATION DE NETTOYAGE IB RUBINETTI

Aujourd'hui, les robinetteries sanitaires et de cuisine modernes, les douches, les accessoires, les lavabos, les cuves et les radiateurs sont constitués de matériaux très différents pour répondre aux besoins du marché en termes de conception et de fonctionnalité. Pour éviter tout dommage et toute prétention, lors du nettoyage.

En ce qui concerne le nettoyage des produits IB RUBINETTI, les points suivants doivent être respectés:

- Utilisez uniquement du matériel de nettoyage explicitement fourni pour ce type d'application.
- N'utilisez jamais de produits de nettoyage contenant de l'acide chlorhydrique, de l'acide formique, de la lessive de blanchiment chlorée ou de l'acide acétique, car ils causent des dégâts considérables.
- Les nettoyeurs acides au phosphore ne sont applicables que dans certaines conditions.
- Le mélange de différents agents de nettoyage n'est généralement pas autorisé.
- N'utilisez jamais de produits de nettoyage ou d'appareils ayant un effet abrasif, tels que poudres de nettoyage inappropriées, tampons éponges ou chiffons en microfibre.
- Les instructions des fabricants d'agents de nettoyage doivent être suivies à la lettre.
- Le nettoyage doit être effectué avec un dosage spécifié de détergent de nettoyage, pendant une durée appropriée, liée à l'objet et adaptée aux besoins.
- Le calcaire doit être enlevé en le nettoyant régulièrement.
- Lorsque vous utilisez des nettoyeurs en spray, vaporisez la solution de nettoyage sur un chiffon doux ou une éponge, jamais directement sur les produits IB RUBINETTI, car le spray atomisé pourrait pénétrer dans les ouvertures et les fentes du produit et causer des dommages.
- Après le nettoyage, rincez abondamment à l'eau claire pour éliminer tout résidu de nettoyage.
- L'utilisation de nettoyeurs à vapeur n'est pas autorisée. Les températures élevées peuvent endommager les produits.

Important

Les résidus d'articles de toilette, tels que les savons liquides, les shampooings et les gels pour la douche, les teintures pour les cheveux, les parfums, les lotions après-rasage et les vernis à ongles peuvent également causer des dommages. Ici aussi: après l'utilisation, rincez soigneusement à l'eau pour éliminer les résidus. De même, ne stockez pas d'agents de nettoyage ou de produits chimiques sous les produits, par exemple dans une coiffeuse, car les vapeurs peuvent endommager les produits.

Les composants dont les surfaces sont endommagées doivent être remplacés afin d'éviter tout risque de blessure. Les dommages causés par un traitement inapproprié ne sont pas couverts par notre garantie.



IB RUBINETTI

IB RUBINETTI SINGAPORE

(By Equip-Bathrooms Pte Ltd)
33 Ubi Avenue 3, #04-35,
Vertex Tower B, Singapore 408868
T: +(65) 6339 5588

IB RUBINETTI MALAYSIA

(By Equip-Design & Supply Sdn Bhd)
No. 2a-2, Jalan PJU 5/17, Dataran Sunway,
47810 Kota Damansara, Petaling Jaya,
Selangor Darul Ehsan, Malaysia
T: +(603) 6151 5582

IB RUBINETTI JAKARTA

(Partner: Sandimas)
Muara Karang Blok L-IX Selatan
No. 1-7, Jakarta Utara 14450, Indonesia
T: (021) 6669 1080
M: 081 6111 4488
E: linda@sandimasgroup.com

IB RUBINETTI BALI

(Partner: Sandimas)
Jl. Gatot Subroto Barat No. 688,
Denpasar Utara, Kota Denpasar, Bali 80111
Indonesia
T: (0361) 849 5088
M: 081 6111 4488
E: linda@sandimasgroup.com

IB RUBINETTI THAILAND

(Partner: Keith & Kym Co. Ltd)
72-74 Soi Pramote2, Silom Road
Suriyawong, Bangrat, Bangkok
10500, Thailand
T: (662) 635 6873-4
E: kris@keithandkym.com

IB RUBINETTI MYANMAR

(Partner: M.L.O.V. Co., Ltd.)
22(A), 2nd flr., Marchetti Showroom,
Kaba Aye Pagoda Road, Bahan Township,
Yangon - 11210, Myanmar
T: +(95) 94 2118 0716
E: champ@mlovmyanmar.com

IB RUBINETTI LAOS

(Partner: Tricontinental Trading)
Le Comptoir Boutique, 2nd Floor
House 073/ Unit 19, Hom Hengboun Noi,
Ban Haisok, Chanthabouly, Vientiane,
LAO PDR
T: (856) 21 254400

IB RUBINETTI VIETNAM - HANOI

(Partner: Hanel Mirolin Joint Stock Company)
Unit 1201-02, 12th Floor, Keangnam Hanoi
Landmark 72, Zone E6, Me Tri Ward, Nam Tu
Liem District, Hanoi, Vietnam
T: (84) 24 3783 3165
E: thuydt@mirolin.vn

IB RUBINETTI VIETNAM - HO CHI MINH CITY

(Partner: Mirolin Southern Joint Stock Company)
2 Pho Quang St, Ward 2,
Tan Binh District, HCM

Join us and find all
information on products
of IB Rubinetti from the
site www.ibrubinetti.it

Seguici e trova tutte le
informazioni sui prodotti
IB Rubinetti dal sito
www.ibrubinetti.it

Rejoignez-nous et trouvez
toutes les informations
sur les produits de IB
Rubinetti sur le site
www.ibrubinetti.it

Credits:

Art Direction and Graphic
Federico Castelli Design

Photography
Pierpaolo Romano
Ottavio Tomasini

Print
COLOR ART

Thanks to:
Ceramica Flaminia
Ceramica GLOBO
Simas
Falper
Cerasa
140raitaliana





IB RUBINETTI