

SERAFINI
MARMI

ENTITY
collection
BATHROOM

SERAFINI
MARMI

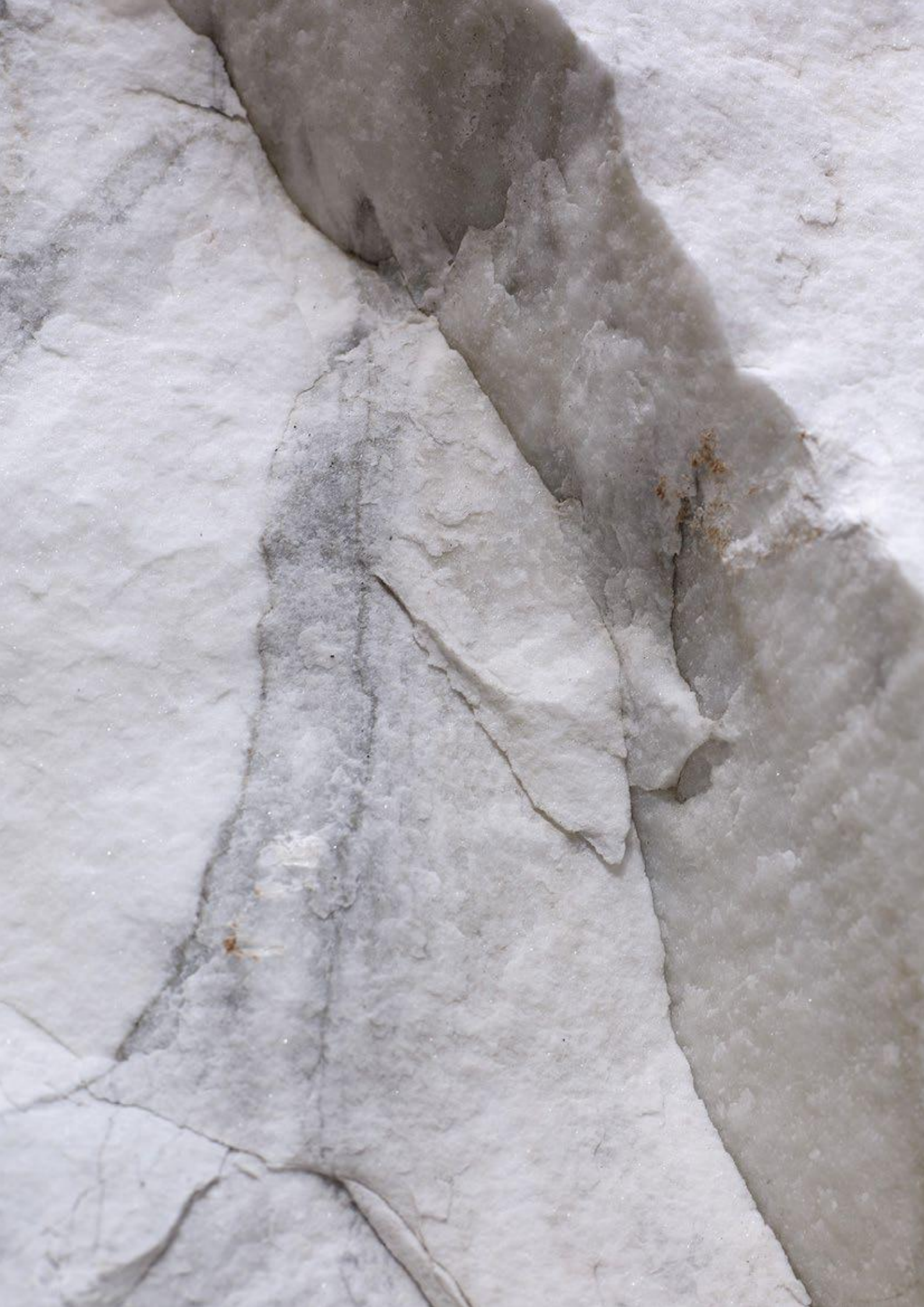

Ogni prodotto è unico e inimitabile
una vera e propria opera d'arte.

Each product is unique and inimitable
a real work of art.

*Il **marmo** e la **pietra** sono prodotti naturali ed in quanto tali possono presentare sensibili variazioni di colore, venatura, tonalità, intrusioni di materiale e stuccature. Ciò è da considerarsi un pregio poiché conferisce valore aggiunto al prodotto finale rendendolo unico ed esclusivo.*

***Marble** and **stone** are natural products and as such may be subject to significant variations in color, texture, shades, mineral intrusion, pores and grouting. This is to be considered as an asset because it adds value to the final product, making it unique and exclusive.*

Tradizione e competitività si sposano in Marmi Serafini grazie ad un innovativo uso di tecnologie avanzate, quali macchinari a lavorazione su più assi e taglio in curva.

L'aggiornamento tecnologico permette non solo di realizzare prodotti dalle forme sorprendenti, finora impensabili, ma anche di assistere il cliente privato e il professionista con software gestionali e progettuali aggiornati e d'avanguardia, nonché di lavorare nel pieno rispetto delle norme etiche e legali di tutela ambientale.

Marmi Serafini è il partner ideale in quanto combina la flessibilità della piccola azienda all'esperienza decennale necessaria per offrire un servizio completo e personalizzabile. Il cliente viene guidato e consigliato nella scelta dei materiali, delle lavorazioni e su richiesta può essere assistito in ogni fase progettuale, dalla misurazione e rilievo, alla progettazione, fino alla posa, alla manutenzione o al restauro.

Marmi Serafini brings together tradition and competitiveness thanks to the innovative use of advanced technology, including machines for multi-axis cutting and curved cutting.

The company uses advanced technology not only to make products having extraordinary and previously unthinkable shapes, but also to assist private and professional customers with latest-generation management and design software and to fully conform to ethical and environmental standards.

Marmi Serafini is an ideal partner since it offers the flexibility of a small company combined with the decades of experience required to provide complete, personalised service.

Customers are guided and advised in the selection of appropriate materials and production methods.

Upon request, the company can assist with every step of the project, from measuring and creating renderings to designing, installing, maintaining and restoring products.



Bruno Fortunato Serafini

Tutto ebbe inizio così:
da un blocco di marmo
esperienza e duro lavoro,
ma è la passione che
rende unico ogni mestiere.

*It all began this way:
from a block of marble,
experience and hard work,
but it is the passion
that makes a difference.*





Da più di due generazioni lavoriamo
per un design tutto italiano

For more than two generations
we work to create an Italian design



Alessandro Serafini

Responsabile aziendale
General Manager

 [alessandro.marmi.serafini](https://www.linkedin.com/in/alessandro.marmi.serafini)
 alessandro@marmiserafini.it

Luca Serafini

Responsabile produzione
Production Director

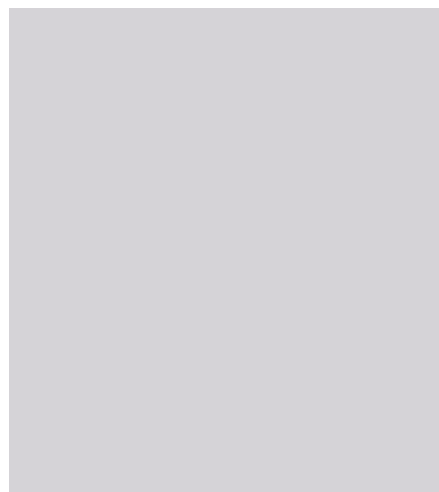

Elia Serafini



Responsabile controllo qualità
Quality control manager







Sara Serafini

Responsabile contabilità
Accounting Manager

 amministrazione.marmi.serafini
 info@marmiserafini.it

Mattia Brunello

Responsabile tecnico
Technical Director

 tecnico.marmiserafini
 tecnico@marmiserafini.it

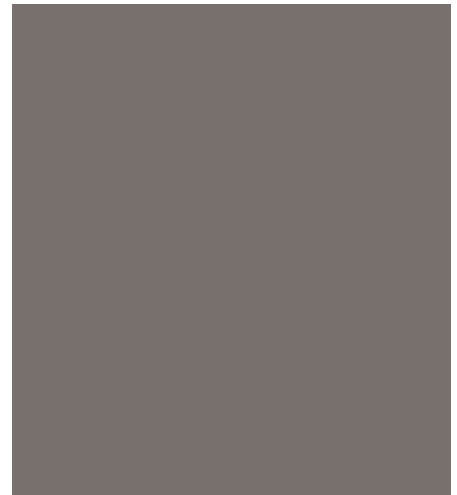



Ester Zordan

Responsabile marketing e di prodotto
Product and Marketing Director

 marketing@marmiserafini.it

Matteo Volpato

Responsabile vendite tedesco
German Sales Manager

 marketing.marmi.serafini
 de@marmiserafini.it

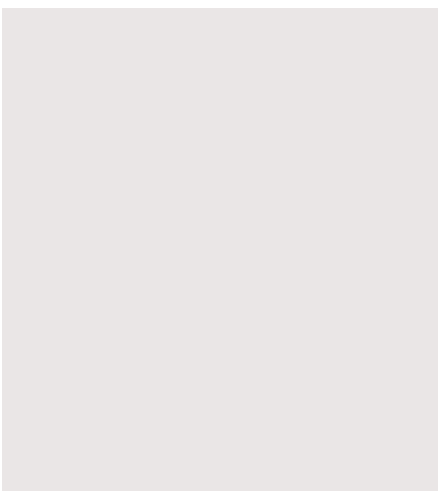

Di cosa ci occupiamo

What we deal with



Arredo *Furniture*

Mobili e complementi
Furniture and equipment



Illuminazione *Lighting*

Linea di illuminazione firmata dal nostro brand Serafini Marmo Luce
Lighting line signed by our brand Serafini Marmo Luce

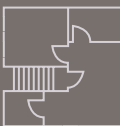

Interni *Interiors*

Progetti d'interni
Interior design projects



Collaborazioni *Collaboration*

Partnership con designer e università per mostre ed eventi
Partnerships with designers and universities for exhibitions and events purposes



Architettura *Architecture*

Scale, archi, profili di porte e finestre, balconcini e colonne
Stairs, arches, doors and windows profiles, balconies and columns



Rivestimenti e pavimenti *Cladding and flooring*

Pavimenti, rivestimenti 3D, classici e a macchia aperta
Clasic and open book cladding and flooring, 3D cladding

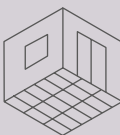

Hotel . Restaurant . Caffè . Wellness . Spa

Speciali progetti su misura per ambienti pubblici
Special customized products made for public spaces

I nostri servizi

Our services

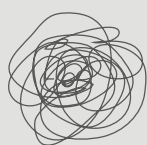

Consulenza progettuale *Project consultancy*



Consulenza in cantiere *On-site consultancy*



Rilievi in cantiere *On-site analysis*



Disegno tecnico *Technical drawing*



Rendering fotorealistici *Photorealistic rendering*



Modellazione 3D *3D modelling*



Consulenza e ricerca materiali *Search of the adequate material*

Indice

index

- 15 **entity** *collection*
- 16 punta
- 22 tetris
- 26 cono
- 32 circle
- 38 square
- 44 ovale

- 51 **rivestimenti 3D** *modular walls*
- 52 punta
- 54 square

- 57 **rivestimenti a macchia aperta**
*open-book wall claddings
and floorings*

- 62 **accessori** *accessories*

- 66 **finiture** *finishes*
- 72 **materiali** *materials*

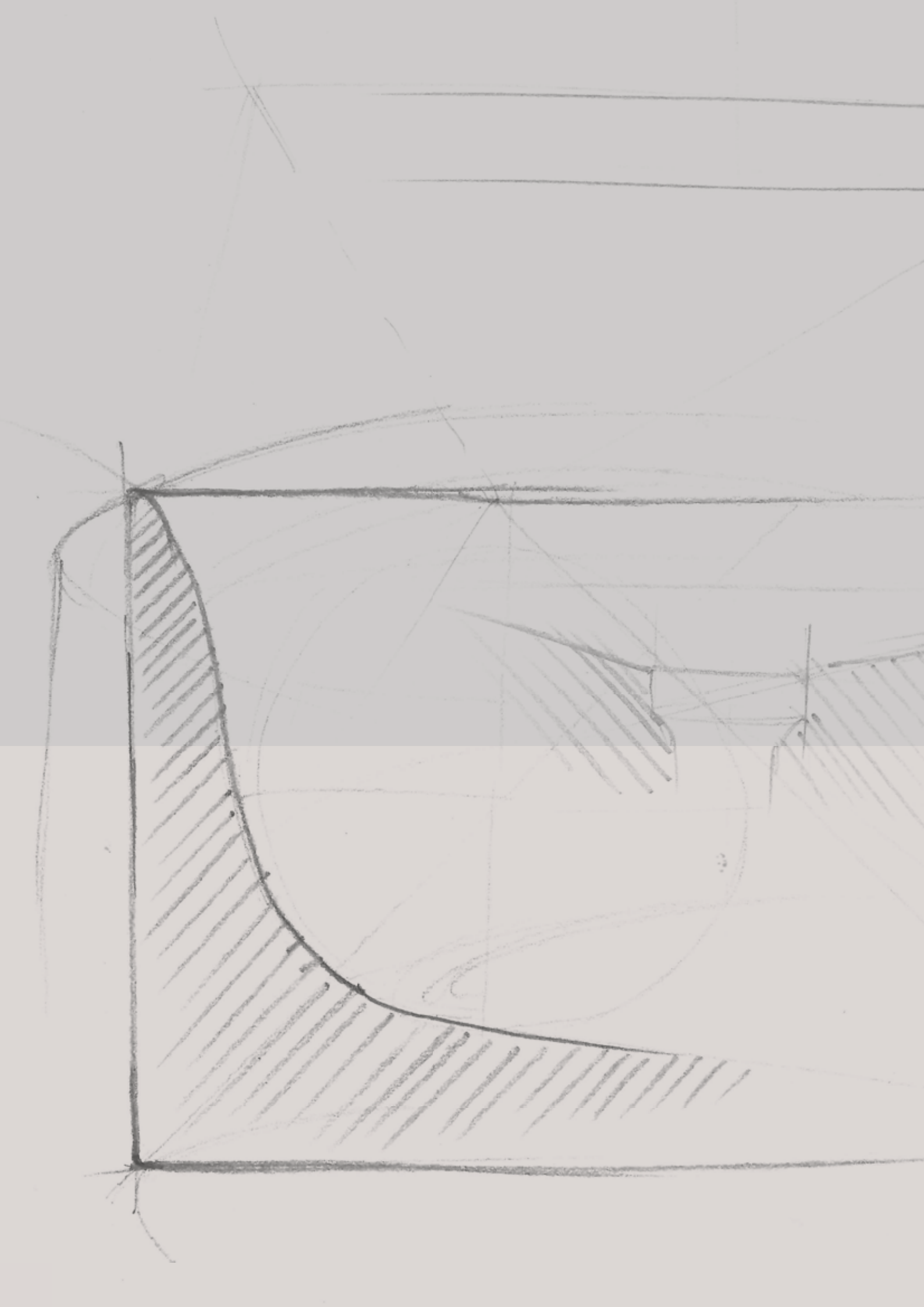



Entity collezione bagno

Entity bathroom collection





nero marquina

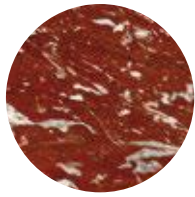

rosso francia



fior di pesco
carnico

su richiesta disponibile anche in altri materiale
on request available also in other materials

PUNTA medium

lavabo da appoggio
countertop washbasin

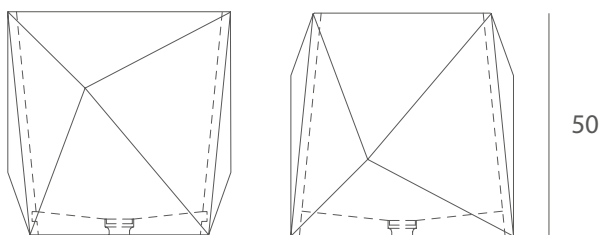
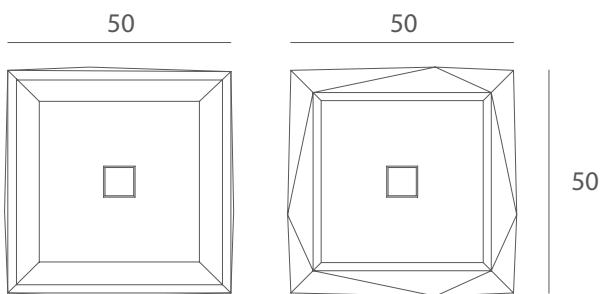

versione assemblata
(disponibile anche a massello)
assembly version
(also available on-block)

peso/weight 65 kg ca.

Peso indicativo variabile in base al materiale
Weight varies according the type of material

materiale/material: nero marquina

dimensioni/dimensions: 50 x 50 x h 50 cm

codice/code: EN-PU01-1N-H3



PUNTA high

lavabo freestanding
freestanding washbasin



nero marquina

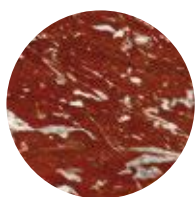

rosso francia



fior di pesco
carnico

su richiesta disponibile
anche in altri materiale
on request available also in
other materials

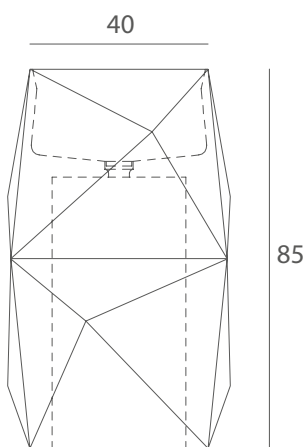
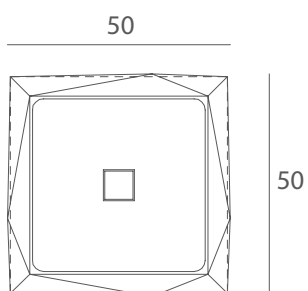

versione a massello
(disponibile anche assemblato)
on-block version
(also available assembly)

peso/weight 145 kg ca. a massello
130 kg ca. assemblato

Peso indicativo variabile in base al materiale
Weight varies according the type of material

materiale/material: nero marquina

dimensioni/dimensions: 50 x 50 x h 85 cm

codice/code: EN-PU01-1N-H3





nero marquina

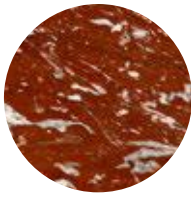

rosso francia



fior di pesco
carnico

su richiesta disponibile anche in altri materiale
on request available also in other materials

PUNTA bath

vasca da bagno
bath

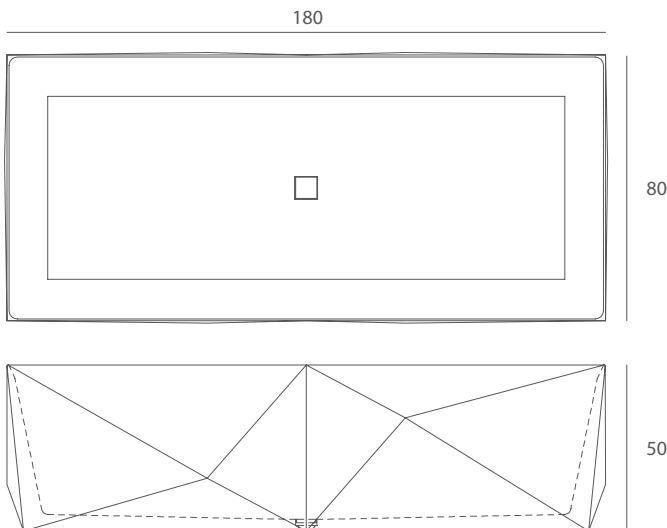

versione assemblata
(disponibile anche a massello)
assembly version
(also available on-block)

peso/weight 420 kg ca.

Peso indicativo variabile in base al materiale
Weight varies according the type of material

materiale/material: nero marquina

dimensioni/dimensions: 180 x 80 x h 50 cm

codice/code: EN-PU03-U3





nero marquinia

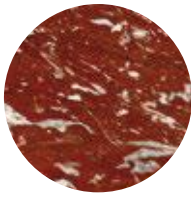

rosso francia



fior di pesco
carnico

su richiesta disponibile anche in altri materiale
on request available also in other materials

PUNTA shower

piatto doccia con scarico a scomparsa
shower tray with foldaway drainpipe

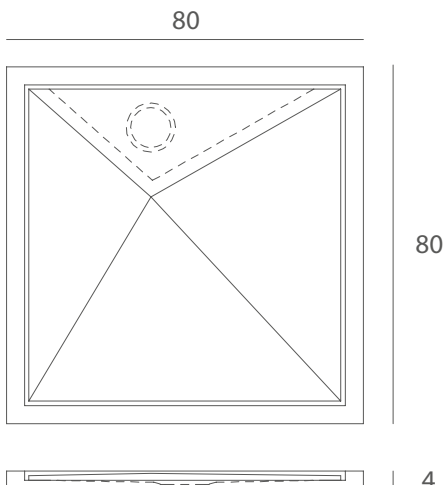

peso/weight 65 kg ca.

Peso indicativo variabile in base al materiale
Weight varies according the type of material

materiale/material: nero marquinia

dimensioni/dimensions: 80 x 80 x h 4 cm

codice/code: EN-PU02-1S-U3





travertino
classico



breccia sarda

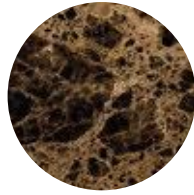

emperador
brown

su richiesta disponibile anche in altri materiale
on request available also in other materials

TETRIS

composizione con cassetti
composition with drawers



materiale/material: vari

dimensioni/dimensions: variabili

codice/code: EN-TE01

composizioni

possibili soluzioni bagno
eleganti elementi per infinite soluzioni

*possible bathroom compositions
stylish elements for countless solutions*

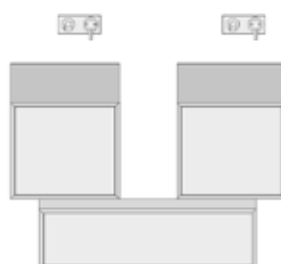
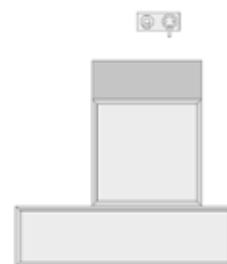
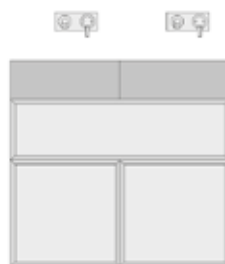
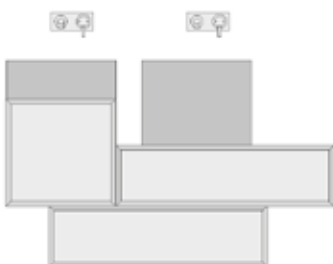
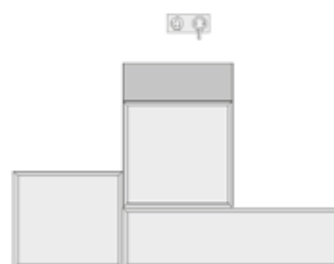
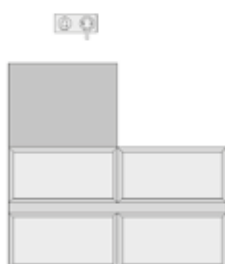
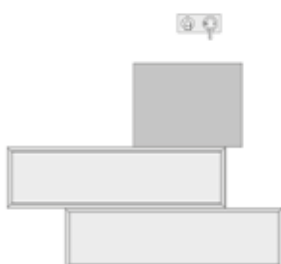



*travertino
classico*



breccia sarda



*emperador
brown*

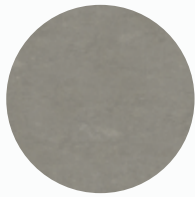

grigio perla



botticino



basalto marrone

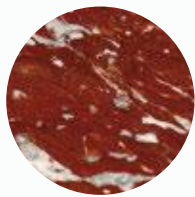

rosso francia



pietra lavica



pietra serena

TETRIS

composizione
composition



materiale/material: vari

dimensioni/dimensions: variabili

codice/code: EN-TE01

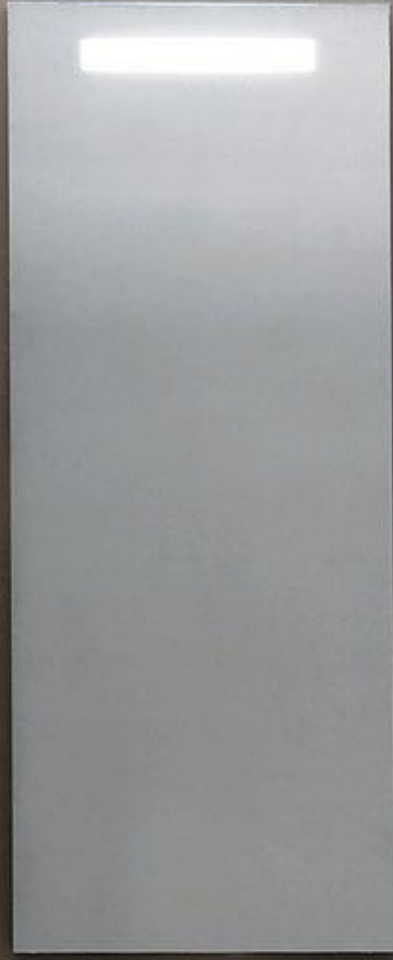
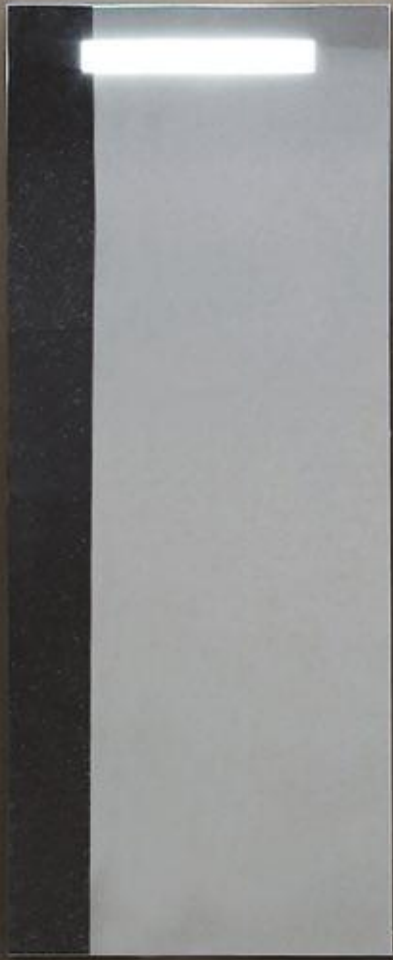

Lavabo Entity Cono high, Marmi Serafini.
26 Washbasin Entity Cono high, Marmi Serafini.

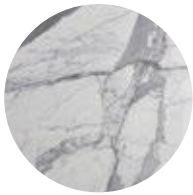

statuario

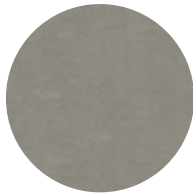

grigio perla



giallo istria

su richiesta disponibile anche in altri materiale
on request available also in other materials

CONO high

lavabo freestanding
freestanding washbasin

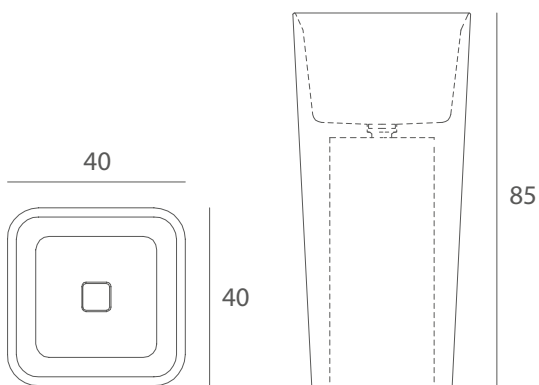

peso/weight 165 kg ca.

Peso indicativo variabile in base al materiale
Weight varies according the type of material

materiale/material: statuario bianco

dimensioni/dimensions: 40 x 40 x h 85 cm

codice/code: EN-CO01-1N-H5

CONO medium

lavabo da appoggio
countertop washbasin



statuario

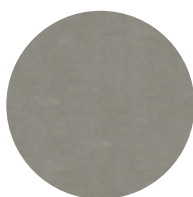

grigio perla



giallo istria

su richiesta disponibile anche in altri materiale
on request available also in other materials

peso/weight 55 kg ca.

Peso indicativo variabile in base al materiale
Weight varies according the type of material

materiale/material: statuario bianco

dimensioni/dimensions: 40 x 40 x h 50 cm

codice/code: EN-CO01-2N-M5

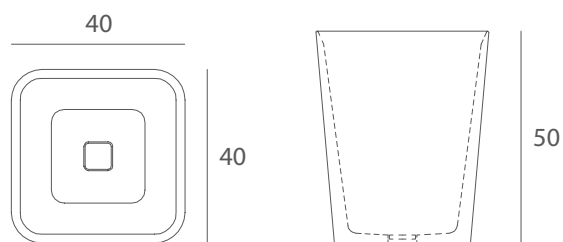

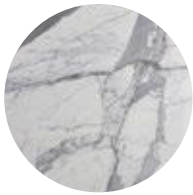

statuario

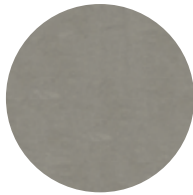

grigio perla



giallo istria

su richiesta disponibile anche in altri materiale
on request available also in other materials

CONO bath

vasca da bagno
bath



180



80



50

peso/weight 420 kg ca.

Peso indicativo variabile in base al materiale
Weight varies according the type of material

materiale/material: statuario bianco

dimensioni/dimensions: 180 x 80 x h 50 cm

codice/code: EN-CO03-5

CONO sgabello

sgabello
stool



giallo istria

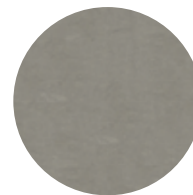

grigio perla



statuario

su richiesta disponibile
anche in altri materiale
*on request available also in
other materials*



peso/weight 110 kg ca.

Peso indicativo variabile in base al materiale
Weight varies according the type of material

materiale/material: statuario bianco

dimensioni/dimensions: 40 x 40 x h 46 cm

codice/code: EN-CO04-3-U4

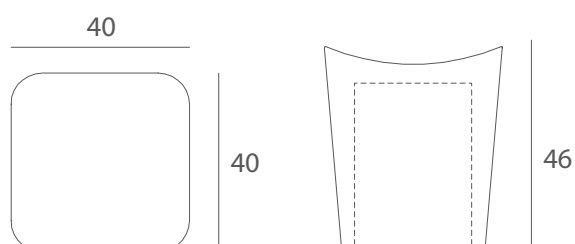

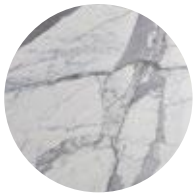

statuario

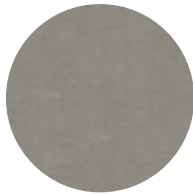

grigio perla



giallo istria

su richiesta disponibile anche in altri materiale
on request available also in other materials

CONO panca

panca

bench



100



40

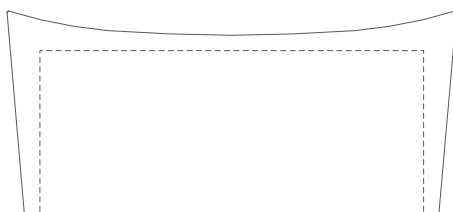

46

peso/weight 220 kg ca.

Peso indicativo variabile in base al materiale
Weight varies according the type of material

materiale/material: statuario bianco

dimensioni/dimensions: 100 x 40 x h 46 cm

codice/code: EN-CO04-4-U5



Lavabo Entity Circle medium, Marmi Serafini | Lampada Fiamma 16, Serafini Marmo Luce.

32 Washbasin Entity Circle Medium, Marmi Serafini | Lamp Fiamma 16, Serafini Marmo Luce.



emperador
brown



calacatta



pietra di Vicenza

su richiesta disponibile anche in altri materiale
on request available also in other materials

CIRCLE medium

lavabo da appoggio
countertop washbasin

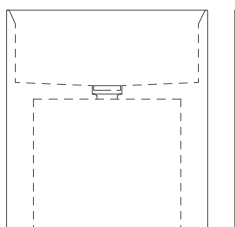

50

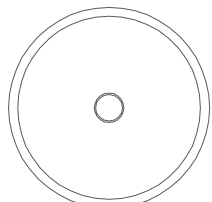

45

peso/weight 54 kg ca.

Peso indicativo variabile in base al materiale
Weight varies according the type of material

materiale/material: emperador brown

dimensioni/dimensions: Ø 45 x h 50 cm

codice/code: EN-CR01-2N-M5

CIRCLE small

lavabo da appoggio
countertop washbasin

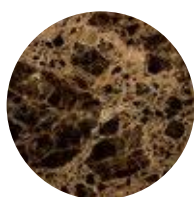

emperador
brown



calacatta



pietra di Vicenza

su richiesta disponibile anche in altri materiale
on request available also in other materials

peso/weight 29 kg ca.

Peso indicativo variabile in base al materiale
Weight varies according the type of material

materiale/material: emperador brown

dimensioni/dimensions: Ø 45 x h 20 cm

codice/code: EN-CR01-2N-S5

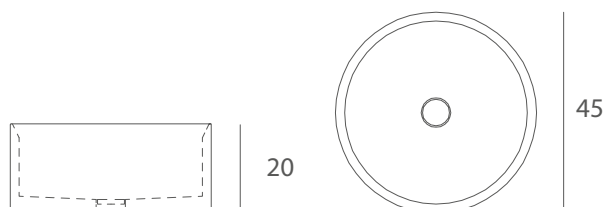



emperador
brown



calacatta



pietra di Vicenza

su richiesta disponibile anche in altri materiale
on request available also in other materials



CIRCLE high

lavabo freestanding
freestanding washbasin

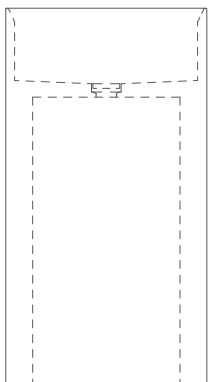

85

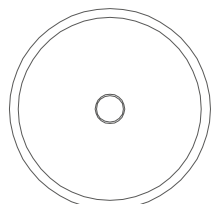

45

peso/weight 130 kg ca.

Peso indicativo variabile in base al materiale
Weight varies according the type of material

materiale/material: emperador brown

dimensioni/dimensions: Ø 45 x h 85 cm

codice/code: EN-CR01-1N-H5

CIRCLE shower 1

piatto doccia con scarico a scomparsa
shower tray with foldaway drainpipe

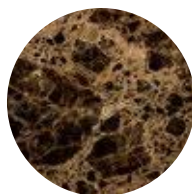

*emperador
brown*



calacatta



pietra di Vicenza

*su richiesta disponibile anche in altri materiale
on request available also in other materials*



peso/weight 70 kg ca.

Peso indicativo variabile in base al materiale
Weight varies according the type of material

materiale/material: emperador brown

dimensioni/dimensions: Ø 80 x h 6 cm

codice/code: EN-CR02-5S-U5

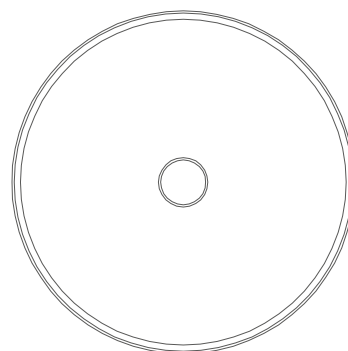

80



6



pietra di Vicenza



calacatta



emperador
brown

su richiesta disponibile
anche in altri materiale
on request available also in
other materials

CIRCLE shower 2

piatto doccia
shower tray

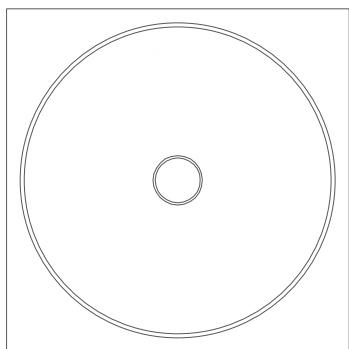

80



6

peso/weight 90 kg ca.

Peso indicativo variabile in base al materiale
Weight varies according the type of material

materiale/material: emperador brown

dimensioni/dimensions: Ø 80 x h 6 cm

codice/code: EN-CR02-5N-U5



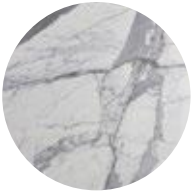

statuario

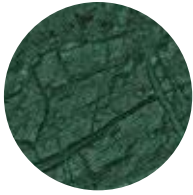

verde guatemala

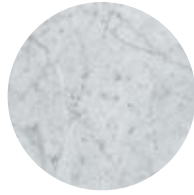

carrara cd

su richiesta disponibile anche in altri materiale
on request available also in other materials

SQUARE bath

vasca da bagno con panca integrata
bath with bench inside

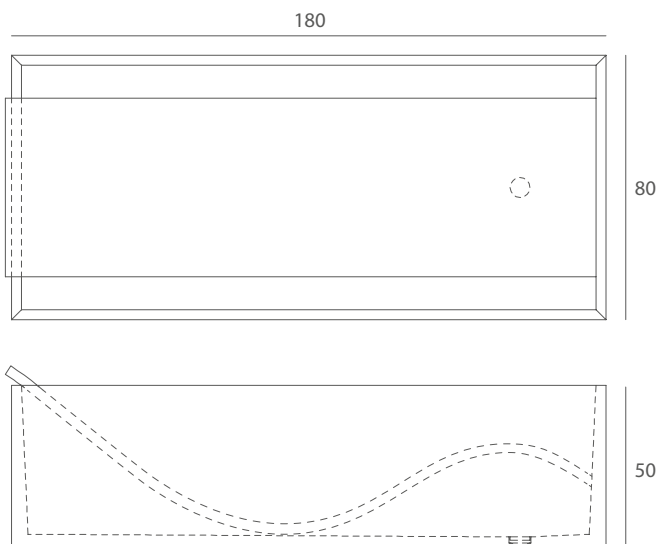

peso/weight 530 kg ca.

Peso indicativo variabile in base al materiale
Weight varies according the type of material

materiale/material: statuario bianco

dimensioni/dimensions: 180 x 80 x h 50 cm

codice/code: EN-SQ3-U5

SQUARE small

lavabo da appoggio con scarico a scomparsa
countertop washbasin with foldaway drainpipe

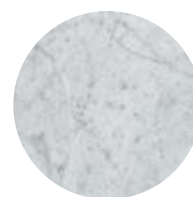

carrara cd

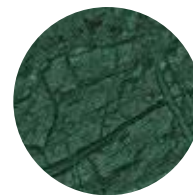

verde guatemala



statuario

su richiesta disponibile
anche in altri materiale
*on request available also in
other materials*

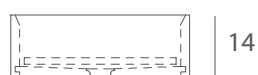

assemblato | assembled

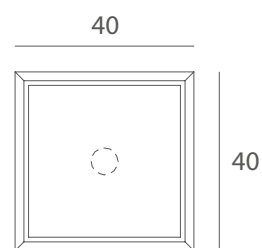

peso/weight 28 kg ca.

Peso indicativo variabile in base al materiale
Weight varies according the type of material

materiale/material: statuario bianco

dimensioni/dimensions: 40 x 40 x h 14 cm

codice/code: EN-SQ01-2S-S5



a massello | on block

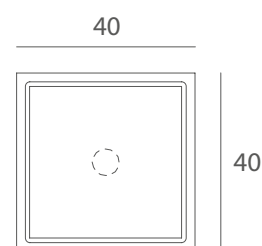

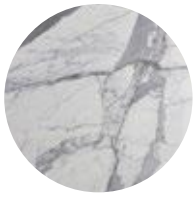

statuario

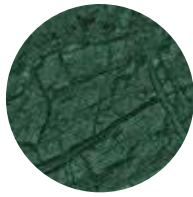

verde guatemala

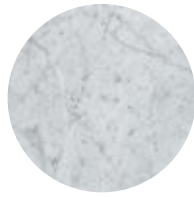

carrara cd

su richiesta disponibile anche in altri materiale
on request available also in other materials

SQUARE medium

lavabo da appoggio con scarico a scomparsa
countertop washbasin with foldaway drainpipe

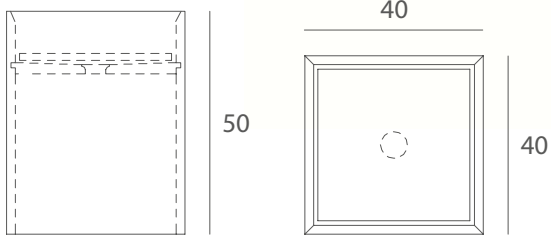

assemblato | assembled

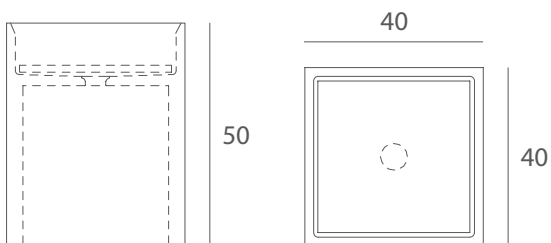

a massello | on block

peso/weight 60 - 85 kg ca.

Peso indicativo variabile in base al materiale
Weight varies according the type of material

materiale/material: statuario bianco

dimensioni/dimensions: 40 x 40 x h 50 cm

codice/code: EN-SQ01-2S-M5

SQUARE high

lavabo freestanding con scarico a scomparsa
freestanding washbasin with foldaway drainpipe



statuario

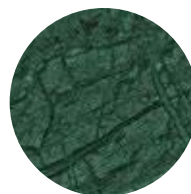

verde guatemala

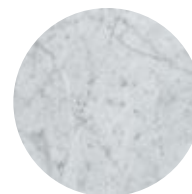

carrara cd

su richiesta disponibile anche in altri materiale
on request available also in other materials

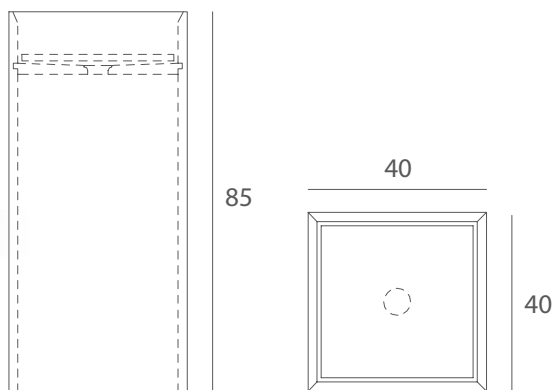

assemblato | assembled

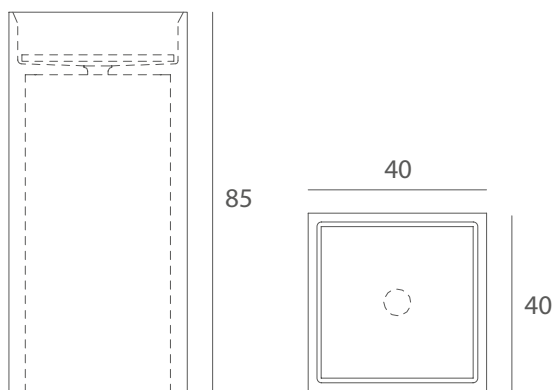

a massello | on block

peso/weight 95 - 165 kg ca.

Peso indicativo variabile in base al materiale
Weight varies according the type of material

materiale/material: statuario bianco

dimensioni/dimensions: 40 x 40 x h 85 cm

codice/code: EN-SQ01-1S-H5

SQUARE shower

piatto doccia con scarico a scomparsa
shower tray with foldaway drainpipe

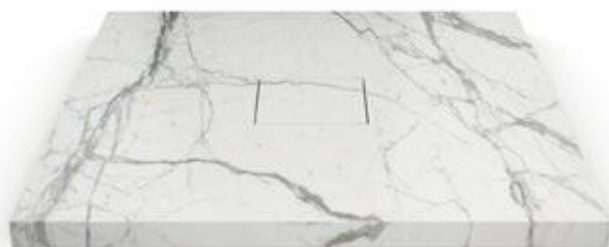

statuario

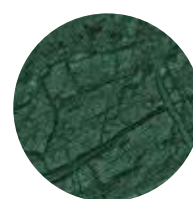

verde guatemala

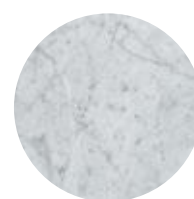

carrara cd

su richiesta disponibile anche in altri materiale
on request available also in other materials

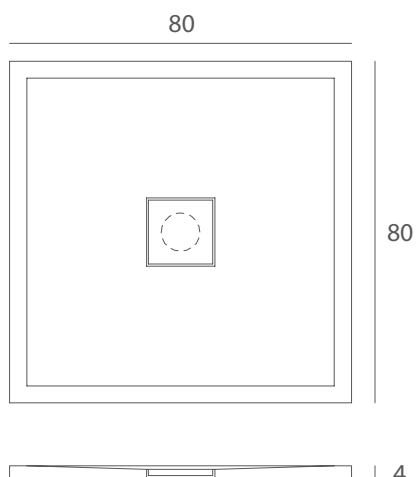

peso/weight 70 kg ca.

Peso indicativo variabile in base al materiale
Weight varies according the type of material

materiale/material: statuario bianco

dimensioni/dimensions: 80 x 80 x h 4 cm

codice/code: EN-SQ02-1S-U5



Vasca Entity Ovale bath, Marmi Serafini.

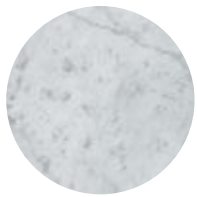

carrara cd

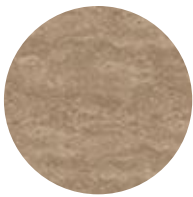

travertino noce



botticino

su richiesta disponibile anche in altri materiale
on request available also in other materials

OVALE bath

vasca da bagno
bath

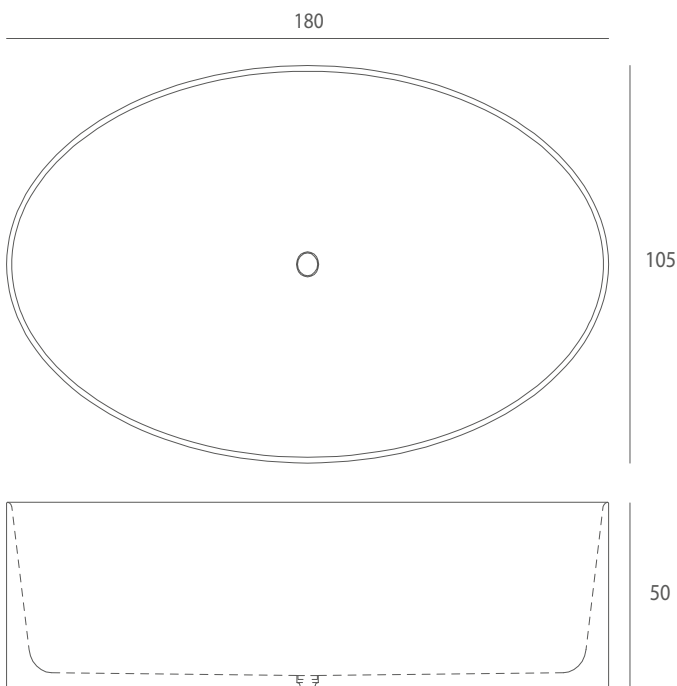

peso/weight 530 kg ca.

Peso indicativo variabile in base al materiale
Weight varies according the type of material

materiale/material: pietra lavica

dimensioni/dimensions: Ø180 x Ø105 x h 50 cm

codice/code: EN-OV03-U

OVALE small

lavabo da appoggio
countertop washbasin



carrara cd



travertino noce



botticino

su richiesta disponibile anche in altri materiale
on request available also in other materials

peso/weight 65 kg ca.

Peso indicativo variabile in base al materiale
Weight varies according the type of material

materiale/material: carrara c

dimensioni/dimensions: Ø 90 x Ø 50 x h 18 cm

codice/code: EN-OV02-2N-S3

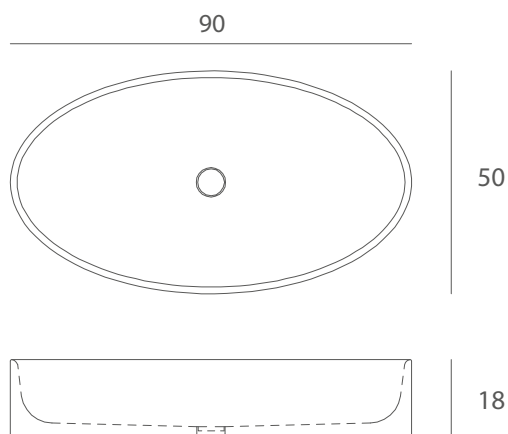

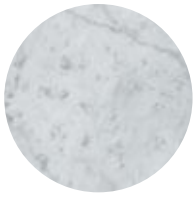

carrara cd



travertino noce



botticino

su richiesta disponibile anche in altri materiale
on request available also in other materials

OVALE medium

lavabo da appoggio
countertop washbasin

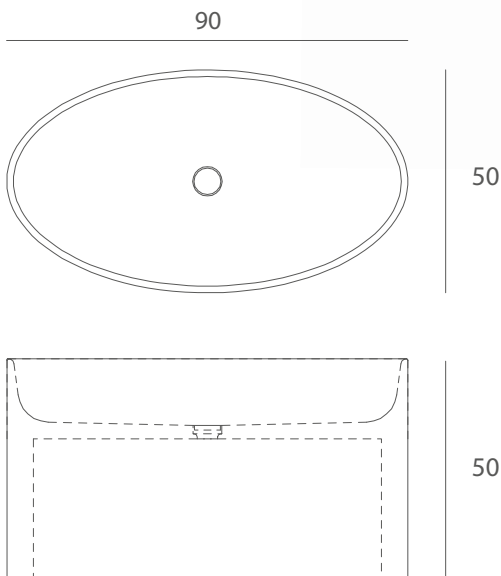
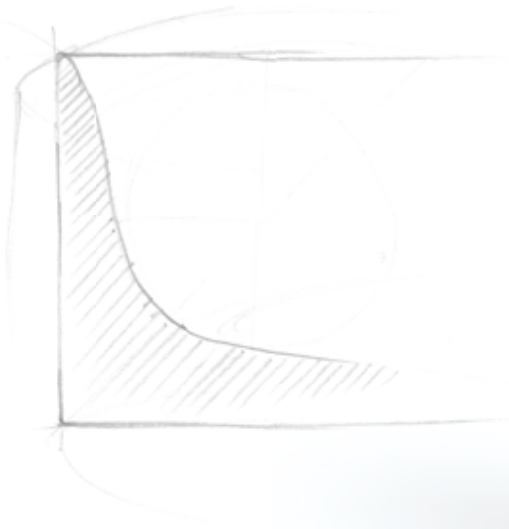

peso/weight 125 kg ca.

Peso indicativo variabile in base al materiale
Weight varies according the type of material

materiale/material: carrara c

dimensioni/dimensions: Ø 90 x Ø 50 x h 50 cm

codice/code: EN-OV02-2N-M3

OVALE large

lavabo freestanding
freestanding washbasin



botticino

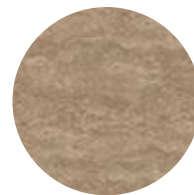

travertino noce

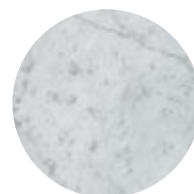

carrara cd

su richiesta disponibile
anche in altri materiale
on request available also in
other materials

90

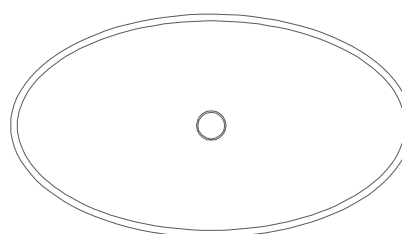

50

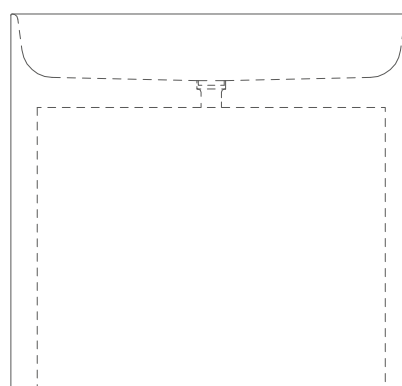

85

peso/weight 240 kg ca.

Peso indicativo variabile in base al materiale
Weight varies according the type of material

materiale/material: carrara c

dimensioni/dimensions: Ø 90 x Ø 50 x h 85 cm

codice/code: EN-OV02-2N-H3

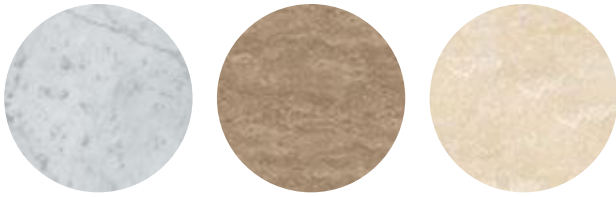

carrara cd

travertino noce

botticino

su richiesta disponibile anche in altri materiale
on request available also in other materials

OVALE shower

piatto doccia con scarico a scomparsa
shower tray with foldaway drainpipe

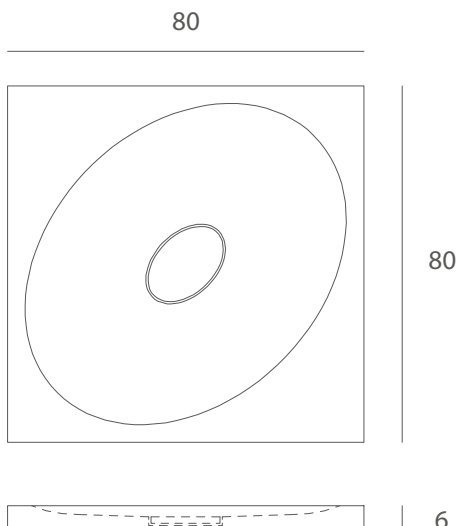

peso/weight 100 kg ca.

Peso indicativo variabile in base al materiale
Weight varies according the type of material

materiale/material: carrara c

dimensioni/dimensions: 80 x 80 x h 6 cm

codice/code: EN-OV02-1S-U3

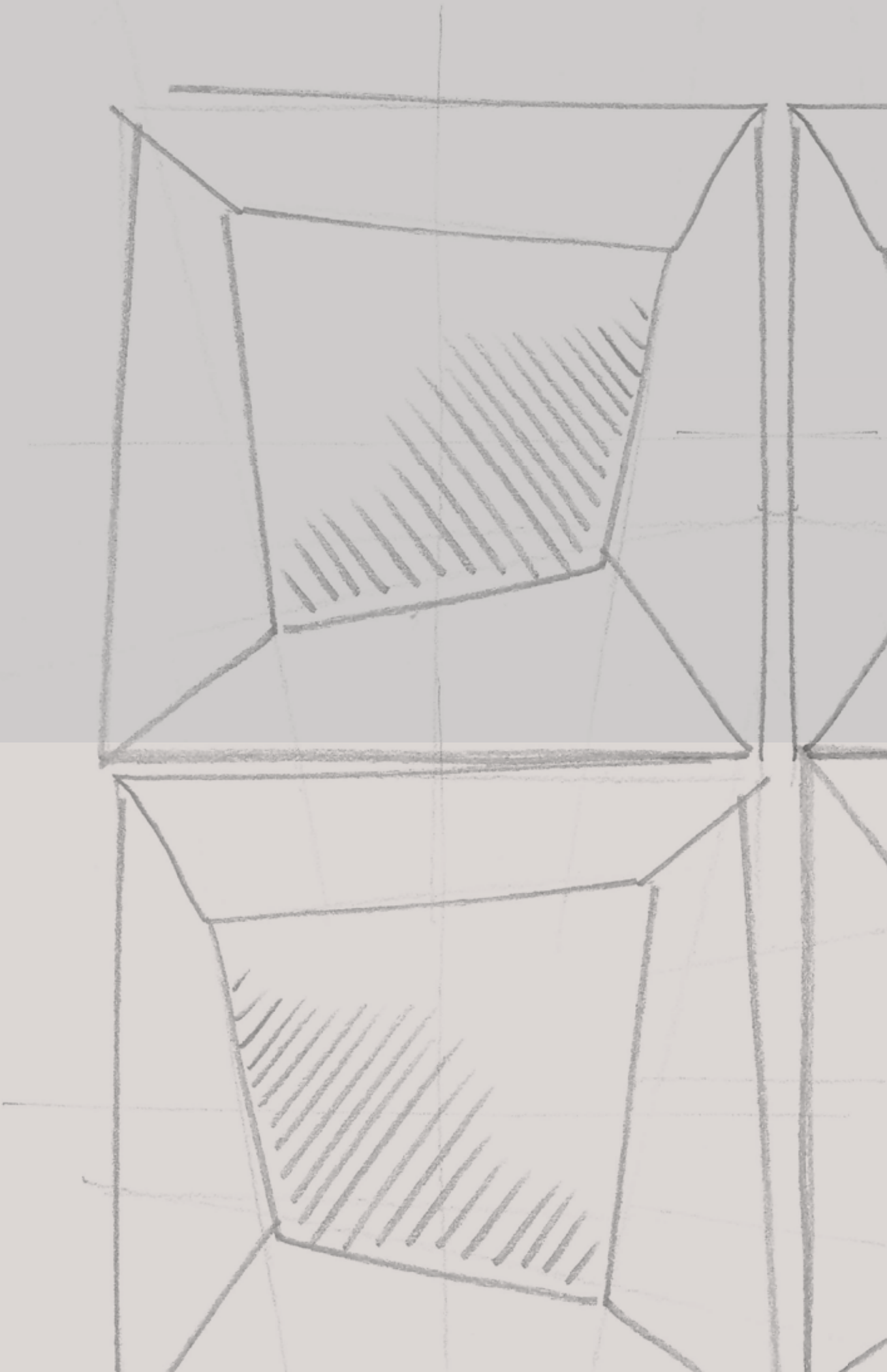

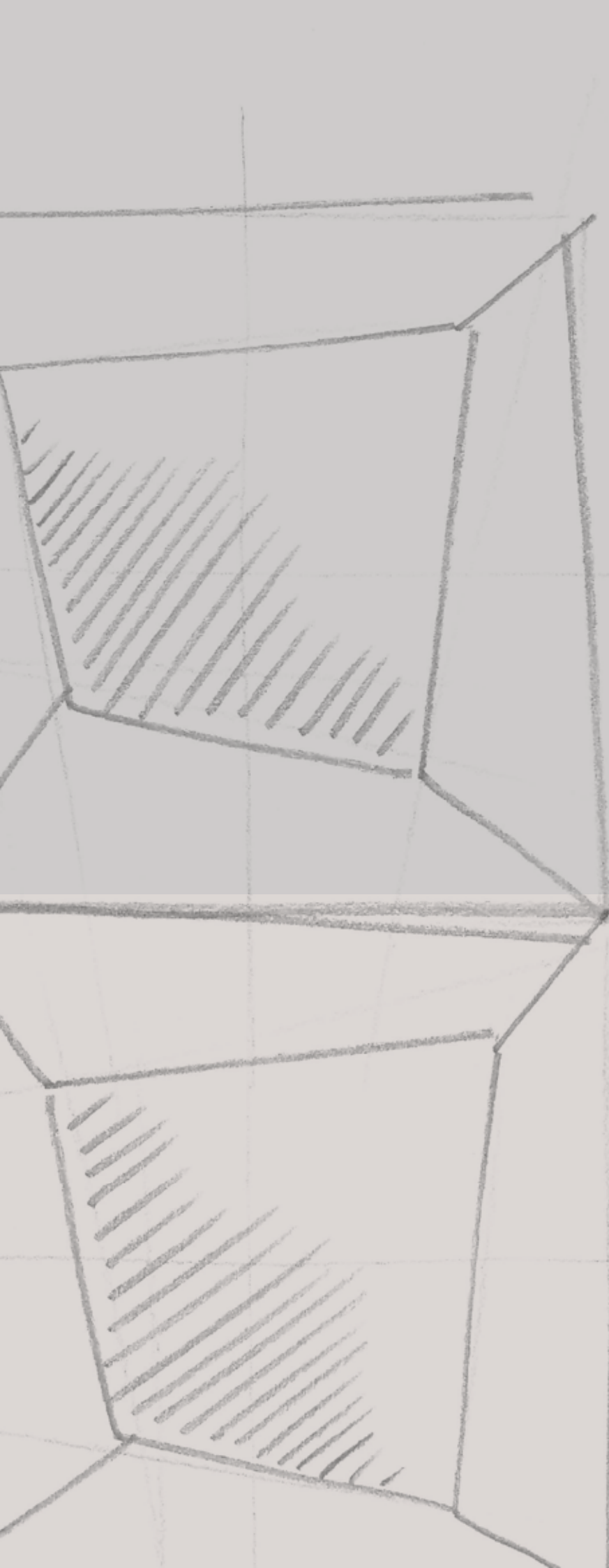

Rivestimenti 3D

3D modular walls





nero marquina

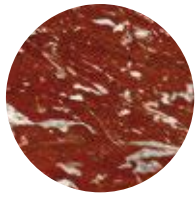

rosso francia



fior di pesco
carnico

su richiesta disponibile anche in altri materiale
on request available also in other materials

PUNTA wall

rivestimento
modular wall

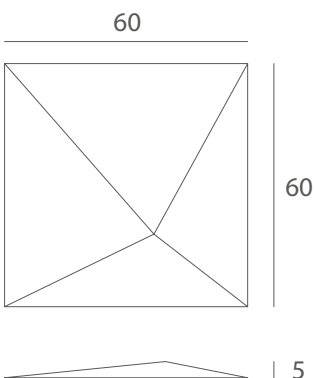

peso/weight 22,5 kg ca. 1 pz.

Peso indicativo variabile in base al materiale
Weight varies according the type of material

su richiesta disponibile anche in altri materiale
on request available also in other materials

materiale/material: nero marquina

dimensioni/dimensions: moduli 60 x 60 x 5 cm

codice/code: RV-PU-4



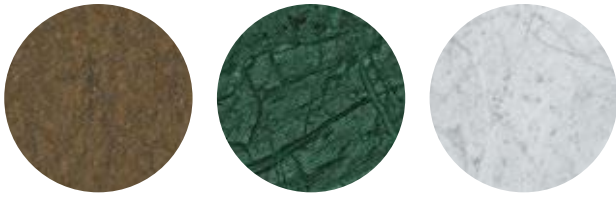

ebano

verde guatemala

carrara cd

su richiesta disponibile anche in altri materiale
on request available also in other materials

SQUARE wall

rivestimento
modular wall

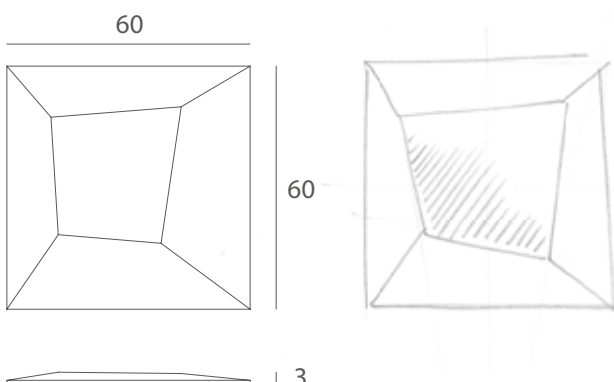

peso/weight 18,5 kg ca. 1 pz.

Peso indicativo variabile in base al materiale
Weight varies according the type of material

su richiesta disponibile anche in altri materiale
on request available also in other materials

materiale/material: ebano

dimensioni/dimensions: 60 x 60 x 3 cm moduli

codice/code: RV-SQ-3



A pencil sketch of a building facade, featuring several vertical lines and circular details that suggest a window or door structure. The drawing is light and gestural, with some areas of shading and cross-hatching. The overall style is architectural and conceptual.

Rivestimenti a macchia aperta

open-book wall claddings and
floorings



58 Rivestimento parete a macchia aperta in statuario bianco, Vasca Entity Cono in pietra lavica, Marmi Serafini.
Wall open-book cladding, statuario bianco, Vasca Entity Cono, pietra lavica, Marmi Serafini.

Classic cladding

rivestimento a macchia aperta
open-book cladding

rivestimenti
cladding



materiale/material: statuario bianco

dimensioni/dimensions: da lastra, by slabs



siamo **ESPERTI**

we are **EXPERTS**

Dalla foto di un blocco grezzo presentiamo al cliente quali opportunità potrebbero scaturirne.

From the photo of one raw material block we present to the client all the possibilities that might be accomplished

proposta | sample 1

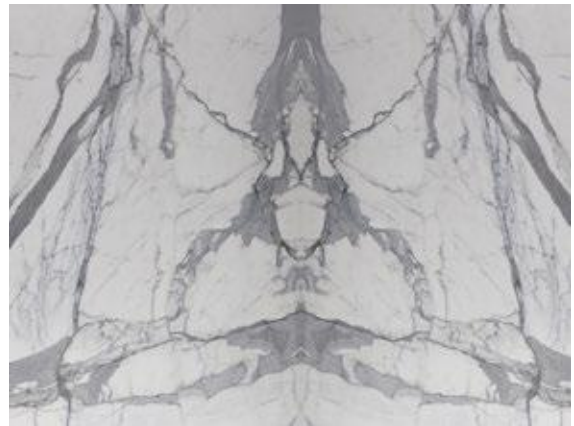

proposta | sample 2



proposta | sample 3



siamo **SPECIALISTI**

we are **SPECIALISTS**

Studiamo ciascun blocco e lastra in ogni loro dettaglio, per sfruttare al massimo il potenziale dei nostri materiali.

We carefully study each block and slab to achieve maximum potential of our materials.

cosa **OFFRIAMO**

what we **OFFER**

Valutiamo e selezioniamo tutte le diverse possibilità di composizione.

We explore and suggest different possible compositions in order to choose the best designed solutions.

proposta | sample 4



proposta | sample 5



proposta | sample 6



siamo **CREATIVI**

we are **CREATIVE**

Sviluppiamo dei render per fornirvi un'immagine realistica del vostro progetto.

We create renderings to provide a more realistic idea of the project and to help you imagine a product in a particular environment.







Accessori

bathroom accessories

Accessories

sistema di appendini con accessori
hangers system with accessories

top

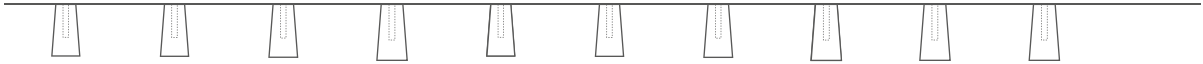

front

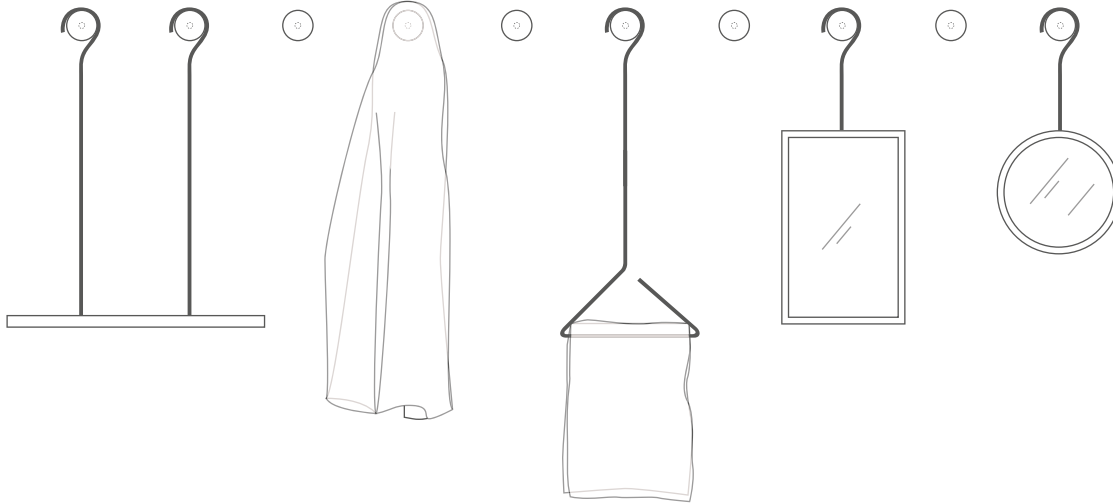

materiale/material: vari

dimensioni/dimensions: varie

Finiture

finishes

La sperimentazione e la voglia di lavorare su forme e motivi nuovi hanno portato alla realizzazione di moderne lavorazioni grazie alle quali sono nati special moods innovativi e di tendenza.

Grazie a nuove tecnologie e ad una continua ricerca e aggiornamento, Marmi Serafini realizza superfici lavorate dai nuovi e sorprendenti pattern, sperimenta forme originali e mette a punto motivi decorativi innovativi e di tendenza.

Le **finiture 2D** sono applicabili solo a superfici piane, mentre le **finiture 3D** sono applicabili a superfici piane e curve.

The experimentation and the desire to work on new forms and motifs have led to the creation of modern realisation thanks to which were born innovative and trendy special moods.

Thanks to new technology, continual research and keeping up to date, Marmi Serafini produces surfaces having unique new patterns, realizes original shapes and creates innovative and stylish decorative motifs.

***2D finishes** are applicable only on flat surfaces, while the **3D finishes** can be applied both on flat and curved surfaces*

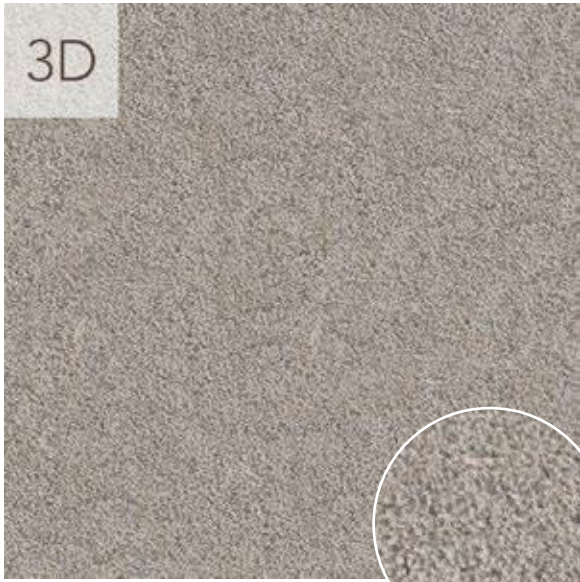

bocciardato

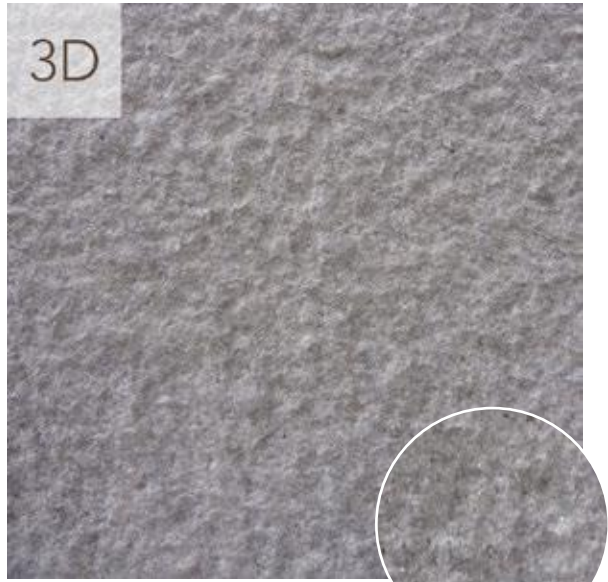

bocciardato grosso

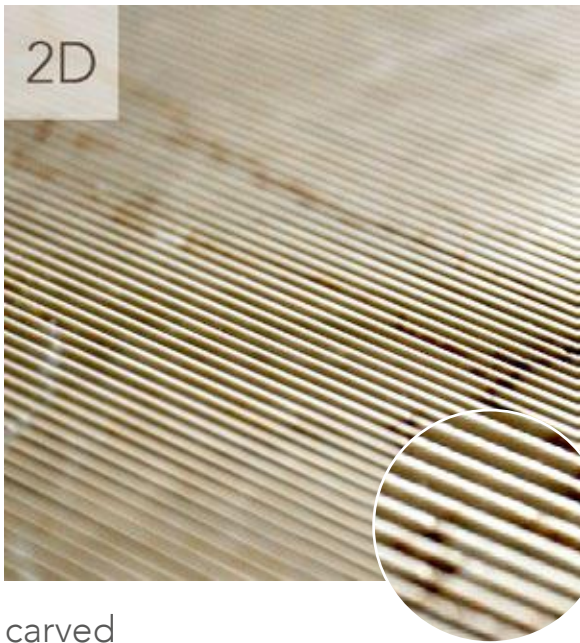

carved

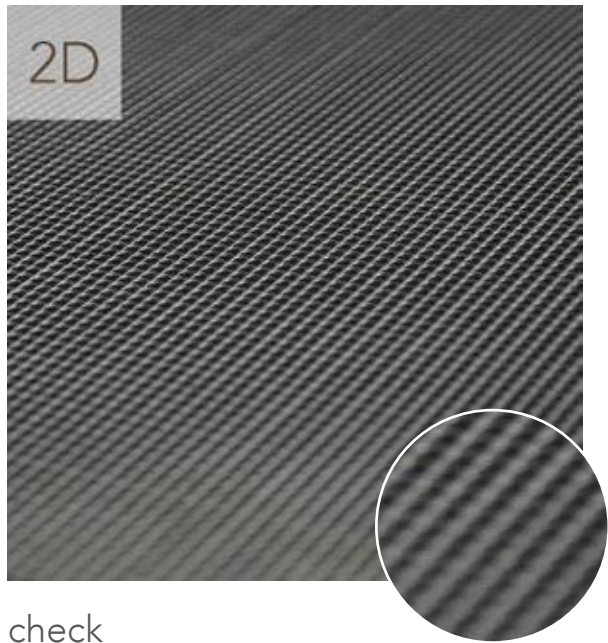

check

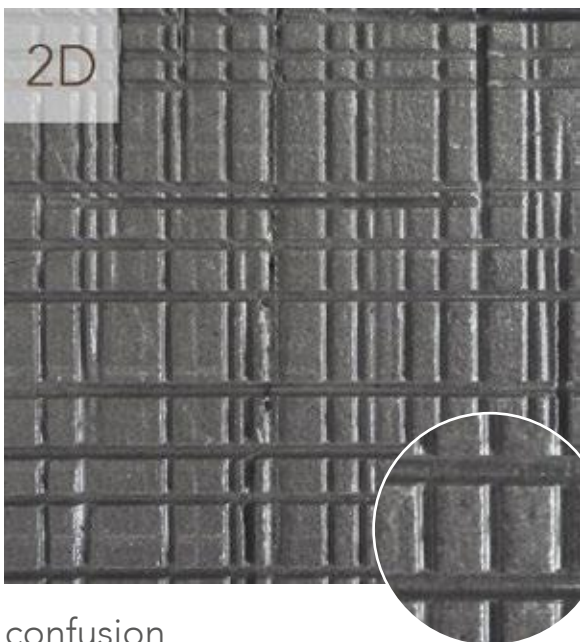

confusion

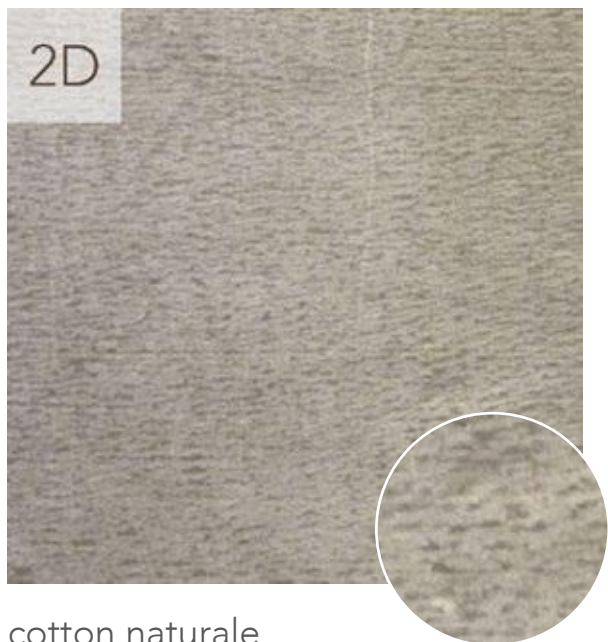

cotton naturale

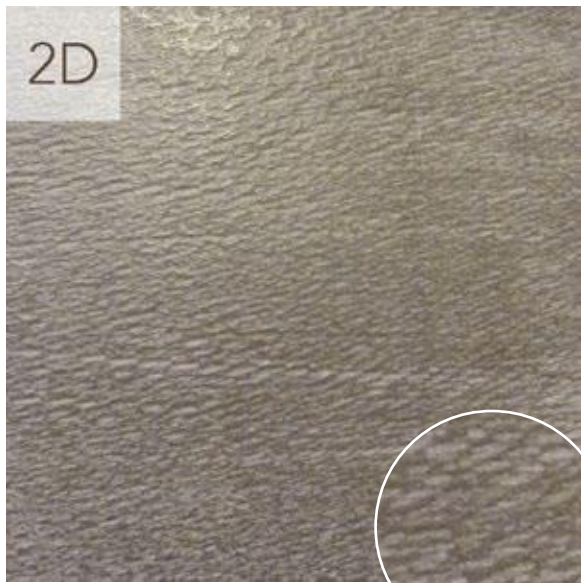

cotton spazzolato



effetto pelle

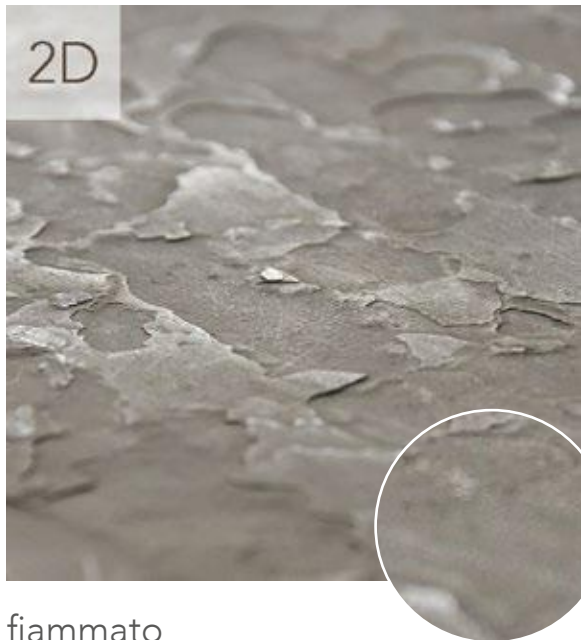

fiammato



flambé



graffiato e spazzolato



levigato

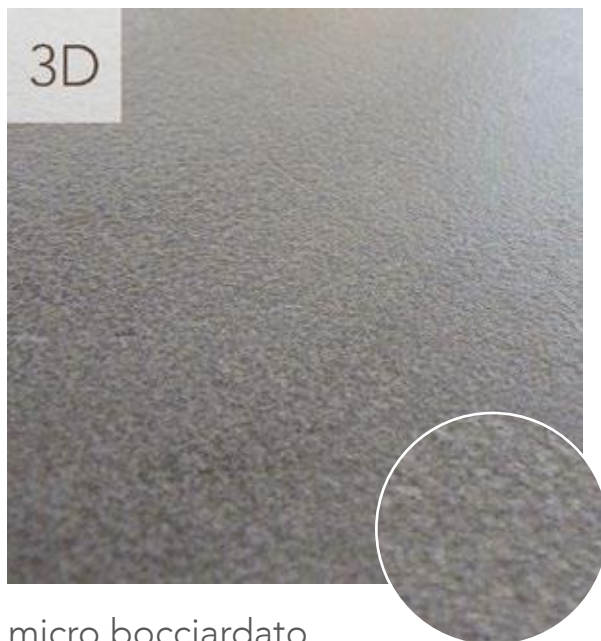
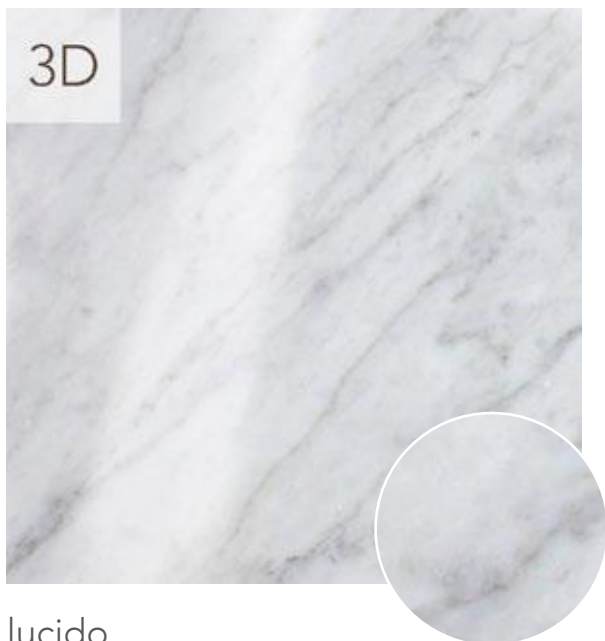

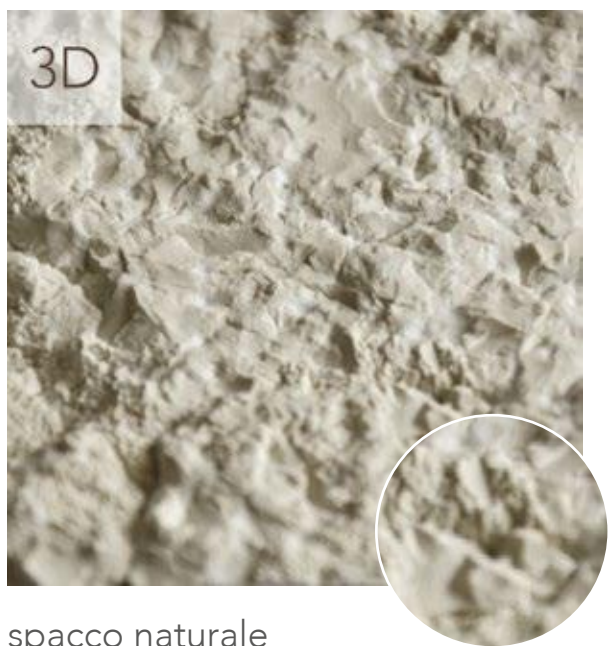
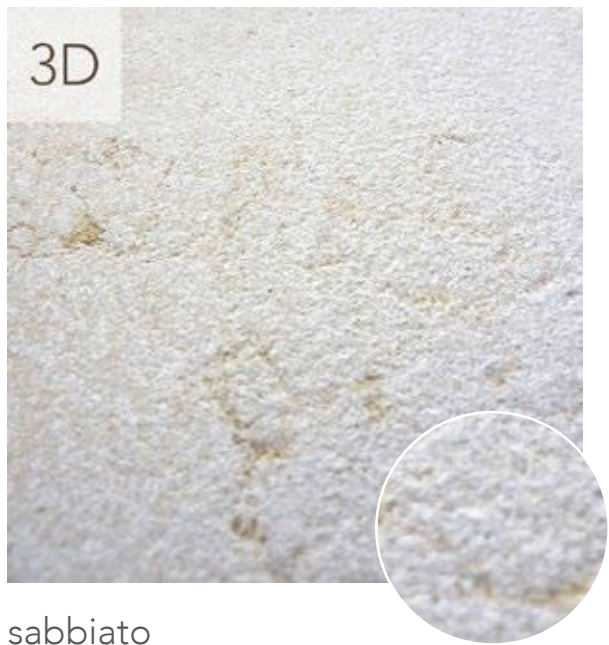
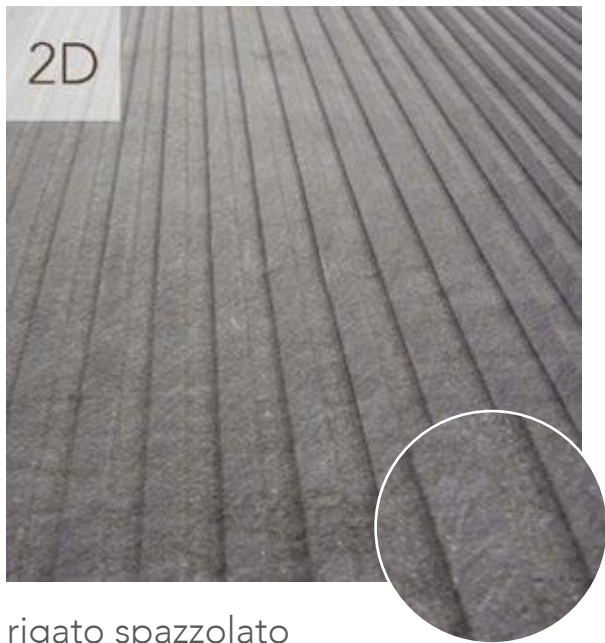



spazzolato



strato

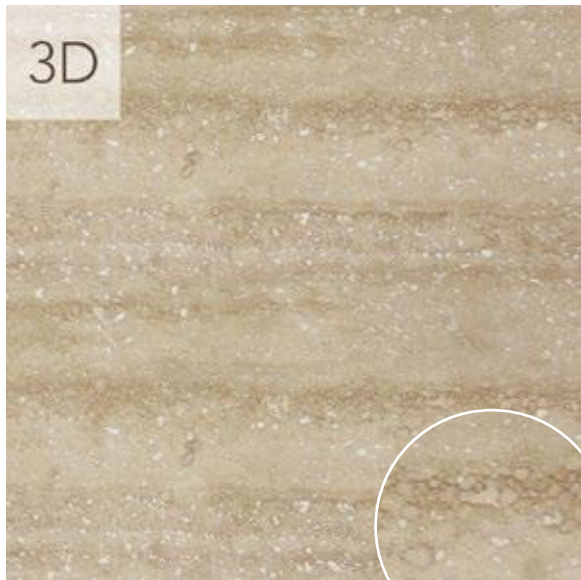

stuccato e spazzolato

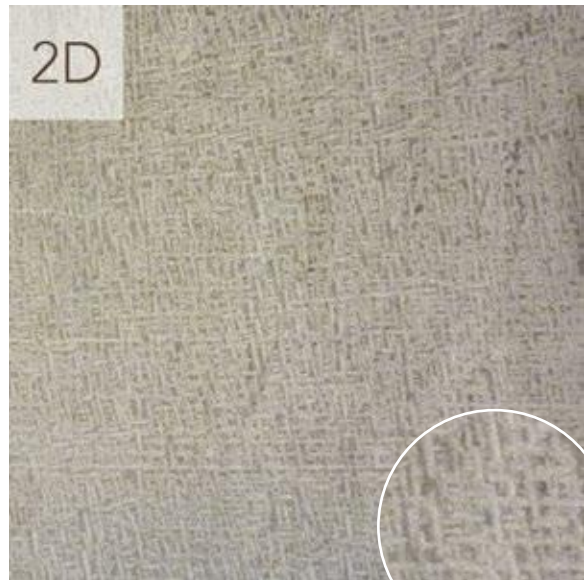

tela naturale

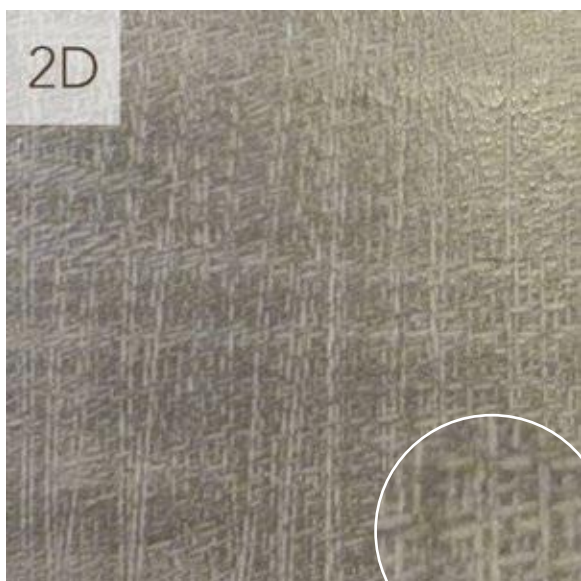

tela spazzolato

Materiali

materials

Il marmo, antico e prezioso materiale, rende ogni elemento un pezzo unico, grazie alle sue inimitabili screziature e per l'ampia sperimentazione formale che esso permette.

La selezione di ogni marmo e pietra naturale è seguita con grande attenzione affinché ogni prodotto possa garantire qualità e prestazioni di altissimo livello.

L'azienda è dotata di un fornito magazzino ma può rifornirsi e lavorare pietre provenienti da ogni parte del mondo a seconda delle richieste.

Marble, an ancient and precious material that thanks to its inimitable veining and wide experimentation possibilities allows the creation of unique items.

In order to guarantee high quality and the greatest success of a particular project, the selection of the marble and natural stone is guided with utmost care.

The company has a wide range of materials in its warehouse but also the possibility to acquire upon clients request other types of natural stone deriving from all around the world.

CLASSE 1



bianco asiago



giallo istria

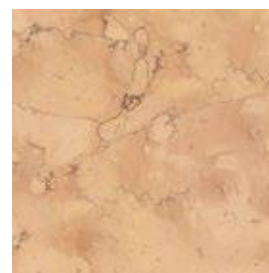

rosa asiago

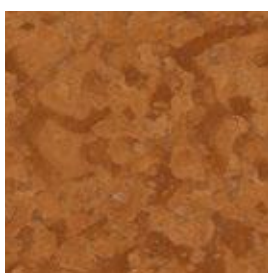

rosso asiago

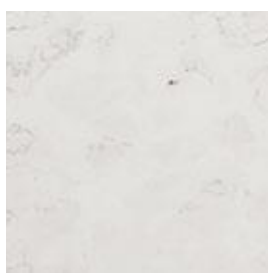

bianco confetto



botticino



carrara cd

CLASSE 2



pietra di Vicenza



sahara



verde guatemala



carrara c



grigio perla



nevada



pietra serena

CLASSE 3



carrara gioia

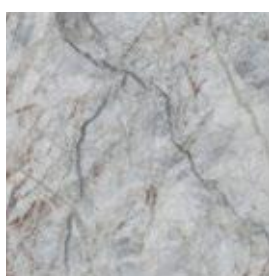

fior di pesco carnico



nero marquina



pietra lavica marrone

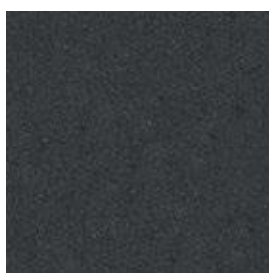

pietra lavica nera



travertino giallo



travertino rosso



travertino romano

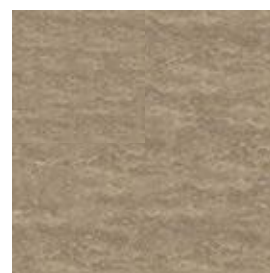

travertino noce



breccia sarda



siena brown



ebano

CLASSE 4

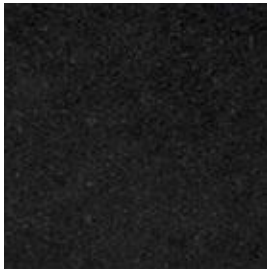

nero assoluto

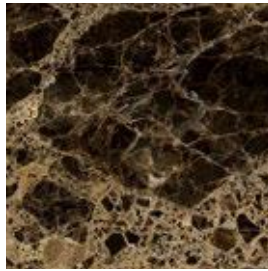

emperador brown



rosso francia

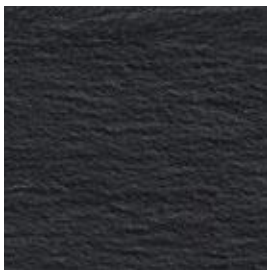

ardesia

CLASSE 5



onice bianco



onice fantastico

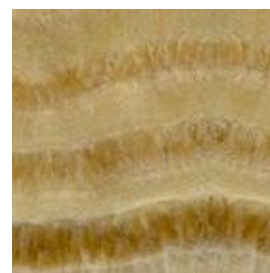

onice miele



onice rosso

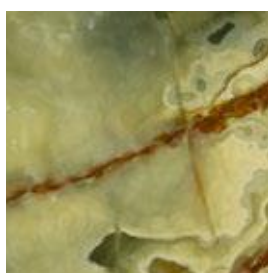

onice verde

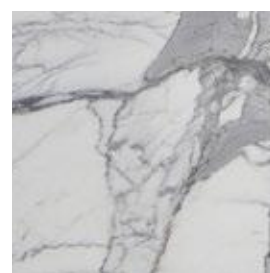

staturario bianco



calacatta

Condizioni generali di vendita

General sales conditions

Condizioni generali

Le presenti condizioni di vendita vengono applicate a tutti i prodotti e servizi effettuati dall'azienda Marmi Serafini sas di via Castiglione 5, 36072 Chiampo (VI), p.iva 0283030241.

Eventuali controversie saranno risolte sotto la giurisdizione italiana e nel panorama italiano.

Le Condizioni non possono essere modificate se non in forma scritta da un direttore di Marmi Serafini sas. Se sono necessari dei cambiamenti, assicurarsi di chiedere che questi siano messi per iscritto.

Prezzi e pagamenti

Salvo che non siano concordate delle condizioni speciali, i prezzi devono essere intesi come prezzi franco fabbrica (non compresi d'imballo e del carico presso lo stabilimento), senza alcuna deduzione o sconto concessi per il pagamento immediato.

I prezzi stimati sono validi per un periodo di 30 giorni dopo la formulazione dell'offerta. I prezzi non sono comprensivi di IVA, tasse di import/export e sconti di alcun tipo se non espressamente indicati nel preventivo.

Ci riserviamo il diritto di aumentare il prezzo dell'offerta presentata per recuperare potenziali costi aggiuntivi sostenuti per far fronte a eventuali modifiche apportate alle specifiche dei prodotti e/o dei servizi richiesti, o come risultato di possibili ritardi causati da qualsiasi inadempimento o lentezza nel fornire istruzioni o informazioni sufficienti e necessarie da parte Vostra.

Se non concordato diversamente in forma scritta, il 30% del prezzo deve essere pagato dopo la conferma dell'ordine. Il restante da pagare deve essere saldato il giorno della spedizione (prima della spedizione).

I costi di trasporto e di assicurazione sono a carico del committente.

Ordini

L'ordine non sarà preso in carico e non verrà indicata una data di consegna finché non avremo ricevuto tutti i seguenti elementi:

- tutti i dettagli/studio/disegni di ciò che si richiede;
- il deposito;
- un ordine di acquisto scritto, compresi gli eventuali dettagli/modalità particolari (o e-mail di conferma);
- i disegni approvati, comprese eventuali indicazioni particolari (o e-mail di approvazione).

Tutti i prodotti restano di nostra proprietà fino a quando non sarà completamente saldata la somma dovuta.

Consegna

Se non concordato diversamente in forma scritta, il termine di consegna è di 25 giorni lavorativi per i prodotti a catalogo, mentre per i progetti sarà concordata con il cliente. Per gli ordini urgenti il tempo di consegna è meno di 25 giorni, e deve essere concordato in forma scritta.

Le date di consegna sono solo indicative. Cercheremo di consegnare tutti i beni alla data concordata. Nel caso improbabile che il vostro ordine non sia reso disponibile entro 25 giorni dalla data concordata, si ha la possibilità di annullarlo dandone comunicazione scritta. Tuttavia, un cambiamento dell'ordine può influire sulla data di consegna che dovrebbe essere riconfermata alla modifica ricevuta. In caso uno o più articoli siano esauriti, v'informiamo e forniremo la data di consegna prevista.

Non rispondiamo per qualsiasi mancanza o ritardi nella fornitura o di consegna causati da eventi o circostanze al di fuori del nostro ragionevole controllo.

Reclami

Qualsiasi reclamo da parte del cliente riguardo difetti, qualità o la mancata corrispondenza alla descrizione del prodotto e/o servizio deve essere notificato per iscritto a Marmi Serafini entro 5 giorni lavorativi dal ricevimento della merce. In queste condizioni Marmi Serafini ha il diritto di sostituire in tutto o in parte la merce a titolo gratuito, oppure a discrezione di Marmi Serafini verrà rimborsato il prezzo della merce o parte di esso.

La Marmi Serafini non avrà alcuna ulteriore responsabilità verso il cliente.

I prodotti realizzati su misura non possono essere sostituiti e neppure restituiti.

Specifiche del materiale

Proprietà del marmo, pietra, onice e travertino: tutti i materiali sono naturali e sono pertanto soggetti a variazioni di colore, venature, tonalità, intrusioni minerali, avallature e stuccature. La pietra utilizzata per un ordine può differire in aspetto grafico da qualsiasi campione in precedenza presentato al cliente. E' comune trovare delle variazioni tra e all'interno delle lastre dallo stesso blocco o cava. Marmi Serafini utilizzerà sempre delle lastre continue per eventuali pezzi adiacenti nel progetto, al fine di garantire la coerenza, per quanto possibile; tuttavia, una corrispondenza esatta non può essere sempre garantita dovute alle possibili variazioni naturali presenti fra e all'interno delle lastre che vengono utilizzate.

General terms and conditions

These terms relate to business carried out under the name of Marmi Serafini sas of Via Castiglione 5, 36072 Chiampo (VI), company number 0283030241.

Any dispute shall be settled under Italian jurisdiction.

Terms may not be varied other than in writing by a director of Marmi Serafini sas. If you require any changes please make sure you ask for them to be put in writing.

Prices and payments

Unless special terms are agreed, the prices should be understood to be prices ex works (excluding packaging and loading at the factory), with no deduction or discount being granted for immediate payment.

Estimated prices are valid for a period of 30 days after which the offer lapses. Prices do not include V.A.T, taxes of import/export or discounts of any description unless specifically stated on the quotation.

We shall be entitled to increase the price to recover any additional costs incurred by us as a result of any changes in specification of goods and/or services which you require, or as a result of any delay caused by any instruction by you or failure by you to give us sufficient information and instruction.

If not agreed in the written form differently, the 30% of the price is to be paid after the confirmation of the order and the rest of the price on the day of the shipment (before the shipment).

Transportation and insurance costs are to be paid by the ordering part.

Order

Your order will not be scheduled or a lead time given until we have received all of the following:

- Full details/survey/drawings of what you require;
- Your deposit;
- A written purchase order, including any special details/arrangements (or confirmation email);
- Signed approval drawings, including any special details (or approval email).

All products remain our property until we are paid all the money you owe us.

Delivery

If not agreed differently in the written form, the delivery time shall be 25 working days for the products in the catalogue, while for the projects the date will be agreed with the client.

For urgent orders the delivery time shall be less than 25 days, and it has to be agreed upon in the written form.

Delivery dates are estimates only. We will endeavour to deliver all goods on the agreed date. In the unlikely event that your order is not made available within 25 days from the order confirmation you have the right to cancel the order by giving written notice to us. However, any significant change of order may have impact on the delivery date and this should be confirmed when amending an order.

In the event that some of our items are being out of stock, we will inform you and give an estimated delivery date.

We shall bear no liability for a failure or delay in supply or delivery that is caused by events or circumstances beyond our reasonable control.

Claim

Any claim by the customer based upon defect, quality or failure to correspond to the description must be notified in writing to Marmi Serafini within 5 working days. Under these conditions Marmi Serafini shall be entitled to choose whether to replace the goods in full or part (free of charge), or to refund the price of goods in full or part.

The Marmi Serafini shall have no further liability to the customer.

Customized products are non-returnable and non-exchangeable.

Material details

Marble, stone, onyx and travertine properties: all materials are natural and are therefore subject to variations in colour, veining, shades, mineral intrusions, pores and grouting. The stone used for an order may differ in look from any sample previously given to customer. It is common to find variation between and within slabs of stone from the same block or quarry. Marmi Serafini will always use matching slabs for any adjacent pieces of work in order to ensure consistency as far as possible; however, an exact match cannot always be guaranteed due to variations between and within slabs that are used.

Alla Marmi Serafini s.a.s. è riservata la facoltà di apportare ai propri prodotti qualsiasi modifica estetica, tecnica, nelle dimensioni e nei colori, ritenuta necessaria, nonché la facoltà di sospendere la produzione in qualunque momento senza preavviso, rinunziata fin d'ora da parte del committente ogni conseguente richiesta risarcitoria. I materiali indicati a catalogo sono puramente indicativi, in disponibilità e facilità o meno nel trovare un dato materiale è un dato molto variabile dettato dalla mercato e dalla natura, perciò Marmi Serafini s.a.s. non assicura la possibilità di realizzazione dei propri prodotti in tutti i materiali indicati. Si declina ogni responsabilità relativa ad eventuali inesattezze contenute in questo catalogo, se dovute ad errori di stampa o trascrizioni.

Marmi Serafini s.a.s. reserves the right to make any and all necessary esthetic, technical, colour or size modifications in order to enhance use and esthetic value, and may suspend the production cycle at any moment without notice. Such instances may not be subject to claim by the client. The materials listed in the catalog are only indicative, availability and ease of finding or not of a given material is a matter very variable dictated by the market and the nature, therefore Marmi Serafini s.a.s. does not ensure the possibility of realization of its products in all materials shown. We decline all responsibilities for any possible uncertainties due to misprints in this catalogue.



EQUIP-BATHROOMS SINGAPORE
- HEAD OFFICE & FLAGSHIP SHOWROOM
(By Equip-Bathrooms Pte Ltd)
33 Ubi Avenue 3, #04-35, Vertex Tower B,
Singapore 408868
T: +(65) 6339 5588

EQUIP-BATHROOMS MALAYSIA
(By Equip-Design & Supply Sdn Bhd)
No. 2a-2, Jalan PJU 5/17, Dataran Sunway,
47810 Kota Damansara, Petaling Jaya,
Selangor Darul Ehsan, Malaysia
T: +(603) 6151 5582

EQUIP-BATHROOMS JAKARTA
(By PT Equip Concepts)
Kompleks Harmoni Plaza, Blok J No. 20,
Jl Suryopranoto No. 2, Kel. Petojo Utara,
Kec. Gambir, Jakarta Pusat 10130, Indonesia
T: +(62) 21 6385 4316

EQUIP-BATHROOMS BALI
(By PT Equip Concepts)
Jl. Sunset Road Barat No. 55B,
Seminyak, Kuta-Bali 80361, Indonesia
T: +(62) 361 4735 036

EQUIP-BATHROOMS LOMBOK
(By Partner)
Mong 11 RT. 111, Jl. Pariwisata Kuta,
Desa Kuta, Kec. Pujut,
Lombok Tengah 73573, Indonesia
T: +(62) 817 5782 806

Email: equip-global@equip-design.com
www.equip-bathrooms.com



Disegnato e prodotto interamente in Italia
Entirely designed and made in Italy

© Marmi Serafini s.a.s 2016